



EDUCA d.o.o., Šibenskih vatrogasaca 14
22000 **Šibenik**, Republika Hrvatska
Tel./fax: 022 218 924, Mob.: 091 356 5655
www.educa-h.hr, e-mail: info@educa-h.hr
Matični broj: 2376059; OIB: 64606800724
Trgovački sud u Šibeniku MBS 100012332
Zagrebačka banka: 2360000-1102021911
IBAN: HR9823600001102021911

PHYSICS

3bscientific.com

MEMORABLE TEACHING MADE EASY!

Dear Customers,

We hope you enjoy thumbing through the latest 3B Scientific® Physics Catalogue. Besides all the tried and true items, you will also find many new innovations and further developments intended for your ambitious and state-of-the-art physics instruction ranging from secondary all the way to university level.

Here we would like to give you just a brief introduction to some of the highlights of our ever expanding physics program: One new addition to the program is our brand-new low-cost system for computer-based experimenting. The **VinciLab** is a modern and versatile graphic data logger with two processors and 8 GB memory. The installed equipment software features applications for measurement data acquisition, user file administration, equipment set-up and is used for wireless connection, surfing on the Internet as well as for video and audio file applications. The corresponding **Coach 7** software is the most versatile and extensive software available for instruction in the STEM subjects. You can find out more about this starting on page 40.

Explore the correlation between temperature and electricity (Peltier and Seebeck effect) with our new **Peltier heat pump**. The system comes in a very handy carrying case which also guarantees sufficient thermal insulation from the environment. Details on this can be found on page 145.

In the area of atomic and nuclear physics you can find all of the equipment involved in experiments on the **normal Zeeman effect**, especially our newly developed cadmium lamp including accessories and the Fabry-Pérot etalon. Our equipment on the subject of **Neurophysiology** is also brand new and can be found starting on page 267. This equipment permits, for example, experiments on intact earthworms for the purpose of exploring nerve function and muscle contraction. We are constantly working on supplementing our product range. Simply stop by and have a look from time to time at **3bscientific.com**. We wish you lots of fun reading and look forward to hearing from you. Should you have any questions, our team is always at your disposal.

Kind regards,



Dr Johannes Recht
Business Field Manager Natural Sciences



➤ 3B Scientific® Physics Experiments Catalogue for Schools and Colleges with over 100 demonstration and practical experiments.

All you have to do is contact us and we will be happy to send you a copy of our experiment catalogue. You can find the catalogue to view as a PDF, for downloading or for ordering under "Request catalogue" in the "Customer Service" area of our web site.

Committed to quality

3B Scientific provides you with good quality at fair prices. Our sophisticated quality management complies with the ISO 9001 standards and the Worlddidac Quality Charter and is regularly approved by independent experts.

That's something you can rely on.



CONTENTS

4 New Products	96 Waves and Sound	184 Solid-state laser physics
6 Student Experiments	96 Wave optics	188 Equipment sets
6 3B Student Kit	98 Water waves	190 Electricity and Magnetism
13 Acoustics kit	99 Mechanical waves	190 Electrostatics
14 Student experiment kits (SEK)	103 Sound	196 Electrical circuits
32 Kröncke optical system for student exercises	111 Ultrasound	206 3B Plug-in component system
34 Basic student experiments	120 Energy and the Environment	210 Charger and discharger
35 Light box	120 Solar energy	211 Electro-chemistry
36 Regenerative energy	121 Fuel cells / Greenhouse effect	214 Magnetism
37 Computer Aided Experimentation	122 Weather	216 Magnetic fields
37 Software Coach 7	123 Noise	222 Conductors in magnetic fields
40 Labinterfaces	124 Heat and Thermodynamics	224 Induction
42 Sensors	124 Thermometer	228 Demountable transformer
50 Mechanics	128 Equivalent of heat	231 Tesla coil transformer
50 Mechanics on a whiteboard	129 Calorimeters	232 Free electrons in gases and in vacuum
51 Measurement of time	130 Thermal expansion	246 Atomic and Nuclear Physics
52 Measurement of length	133 Heat conduction / Heat flow	246 Periodic table of the elements
53 Volume measurement	134 Radiation of heat	247 Millikan's experiment
54 Dynamometers	136 Heat conduction	248 Molecule building sets / Model crystals
55 Helical springs	137 Cyclic processes	250 Fundamentals of atomic physics
56 Balance weights	138 Gas laws	252 Zeeman effect
58 Gravitation / Astronomy	141 Cyclic processes	254 Franck-Hertz experiment
59 Statics	146 Light and Optics	258 Fluorescence of sodium
60 Friction	146 Optics on a whiteboard	258 X-ray apparatus
61 Simple machines	149 Geometric optics	259 Radioactivity
63 Linear motion	150 Kröncke optics	262 ESR/NMR
66 Motion in a plane	152 NEVA optical system	264 Hall effect
68 Physics on a small budget	153 Optics using an optical bench U	267 Neurophysiology
69 Free fall / Uniform acceleration	154 Optics using an optical bench D	270 Instrumentation
70 Vertical and horizontal trajectories	155 Optical lamps on stem	270 Power supplies
72 Rotational motion	157 Optical components on stem	276 Function generators
74 Gyroscope	160 Newton's rings / Fresnel mirror	278 Digital oscilloscopes
75 Oscillations	161 Geometrical objects	280 Hand-held analogue measuring instruments
83 Buoyancy	162 Diffraction elements	282 Hand-held digital measuring instruments
84 Density and volume	165 Filters	286 Digital counters
86 Pressure	166 Prisms / Optical crystals	287 Amplifiers
88 Viscosity / Surface tension	168 CCD HD Sensor	288 Magnetic fields
89 Elastic deformation	169 Wave optics using a laser	289 Magnetic stirrers / Heat sources
90 Vacuum	170 Colour	290 Refractometers
92 Vacuum pumps with hose connections	172 Speed of light / Mirror foil	291 Microscopes
93 Vacuum pumps with flange connections	173 Faraday Effect	292 Video cameras
94 Aerodynamics	174 Pockels effect	294 Laboratory scales
95 Laminar flow	175 Polarisation	296 Lab Material
	176 Spectrum tubes and spectrum lamps	296 Stands, clamps and accessories
	178 Spectrometers	299 Experiment leads and cables
	182 Mach-Zehnder interferometer	302 Glassware
	183 Michelson interferometer	303 Various

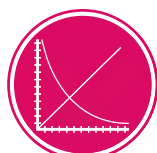

LEGEND

This tip names some experiments from our physics & engineering experiments catalogue which are suitable for the product. You can find these experiments on our web site 3bscientific.com by searching for the number listed.

UE2020200

NEW PRODUCTS



> Page 20
SEK - Electronics
P-1021672



> Page 40
VinciLab
P-1021477



> Page 66
Air Cushion Platform with Inkjet Pucks
P-1021623

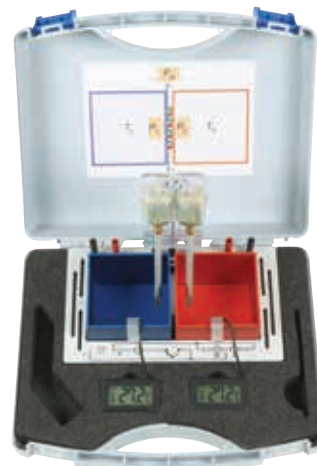

> Page 145
Peltier Heat Pump
P-1020769



Advantages:

- Handy design, robust construction
- Fast and precise measurements
- Large, 3½-digit LCD display



pH-Meter

Digital pH measuring instrument for the measurement of the pH value of aqueous liquids using the immersion probe tips to determine the electrical potential difference between acidic, neutral and basic liquids. The device has a robust housing with compact dimensions and is easy to operate. It is equipped with a large LCD display with continuous background illumination, 2 adjustment potentiometers for calibrating to pH = 4 or to pH = 7 using the matching screwdriver including calibration solution, screwdriver, battery and instruction manual.

pH range:	0 – 14 pH
Resolution:	0.01 pH
Accuracy:	± 0.05 pH
Temperature compensation:	0 – 50°C
Operating voltage:	9 V battery (NEDA 1604)
Display:	3½-digit LCD display, 18 mm, max. 1999
Dimensions:	approx. 150x70x25 mm ³
Weight:	approx. 230 g

P-1020915



Advantages:

- Handy housing design with replaceable probe
- Simultaneous display of pH value and temperature
- Practical single-handed operation for all measurement functions



pH-Meter (2 in 1)

Digital pH meter for the simultaneous measurement of the pH value of aqueous fluids and their temperatures. The measurement of the pH value is performed by determining the electrical potential difference between acidic, neutral and basic fluids. Robust, water-proof housing, large LCD display with permanent background illumination and simple to operate. Including calibrating solution, batteries and instruction manual.

pH range:	0 – 14 pH
Resolution:	0.01 pH
Accuracy:	± 0.05 pH
Temperature compensation:	0 – 50°C
Temperature measurement:	0 – 50°C
Resolution:	0.1°C
Accuracy:	± 1°C
Operating voltage:	4 x 1.5 V (AG-13) batteries
Protection class:	IP 65 water-proof
Display:	3½-digit LCD display, 11 mm, max. 1999
Dimensions:	approx. 190x35x35mm ³
Weight:	approx. 100 g

P-1020914

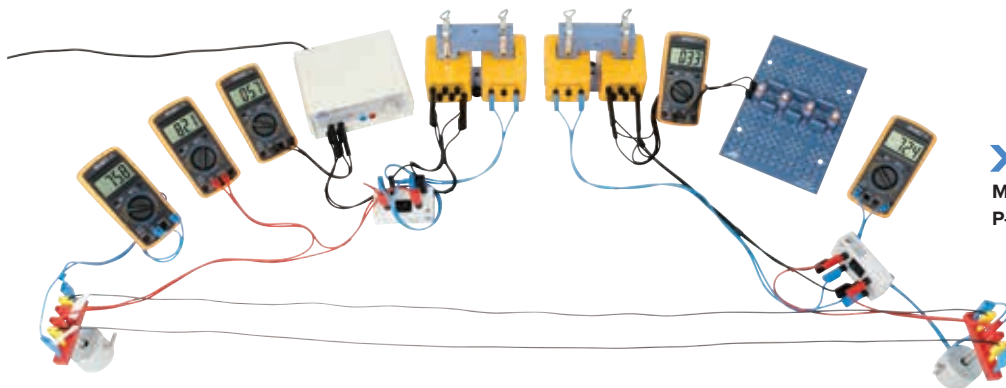

Page 202

Model of Overhead Power Lines, Pair
P-1020769

STUDENT EXPERIMENTS

3B STUDENT Kit

Student Experiments for Lower Secondary Level

The versatile 3B STUDENT Kits allow students in lower secondary level to work independently in setting up and carrying out a comprehensive range of basic experiments on the topics of mechanics, heat, optics, electrostatics and electricity. Detailed instructions for the experiments, divided into pages for students and pages for teachers, help the students to perform the experiments and enable the teachers to make the necessary preparations. Each equipment set-up enables students to work in pairs and requires a bench area of only 400 mm x 250 mm, which is sufficient to ensure a clear and stable set-up. The robust components are made of anodised aluminium, plastic or glass.

CD-ROM containing all different sets of instructions is included!

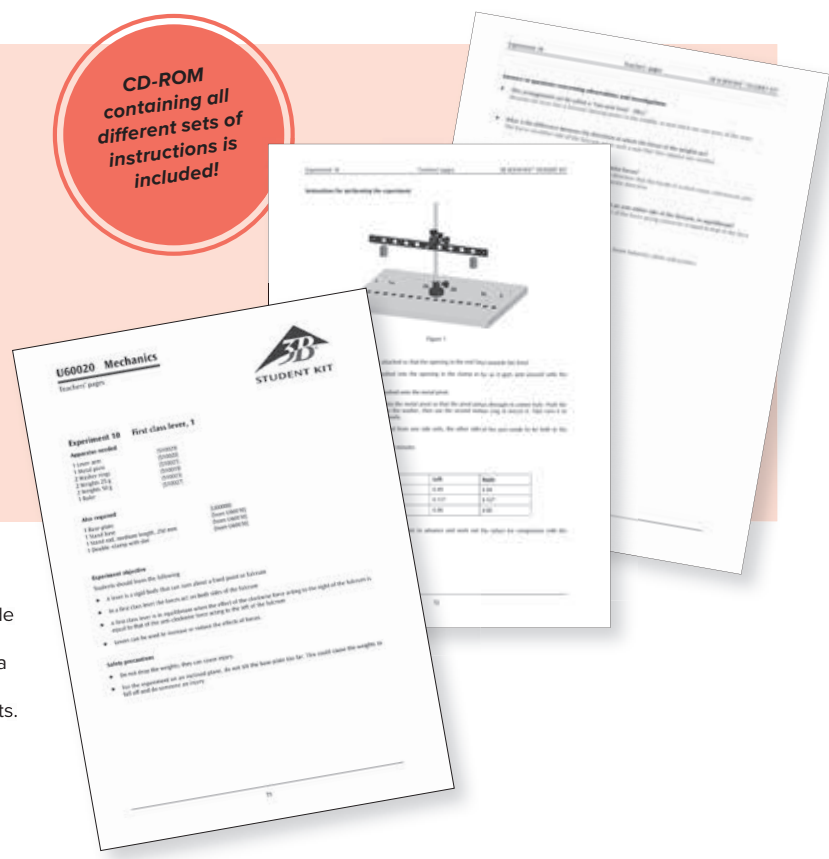

STUDENT Kit – Basic Set

Basic set of apparatus for use with STUDENT Kits for mechanics (P-1000731) and heat (P-1000732). Consisting of a robust base-plate made of plastic, stands and clamps made of anodised aluminium and other components that are used in both mechanics and heat experiments. In a robust plastic box with foam inserts moulded to the shapes of the items plus a transparent lid. Includes a CD with instructions for the experiments.

Contents:

- 1 Base-plate
- 2 Stand bases
- 2 Stand rods, 360 mm
- 1 Stand rod, 250 mm
- 2 Stand rods, 100 mm
- 2 Double clamps with slot
- 1 Clip, 8 mm diam.
- 1 Clip 22 mm diam.
- 1 Clip 27 mm diam.
- 1 Beaker, 500 ml
- 1 Test tube
- 1 Glass tube, 50 mm
- 1 Glass tube, 250 mm
- 1 Silicone tube, 500 mm x 6 mm diam.
- 4 g Glycerine
- 1 CD with sets of instructions for experiments

P-1000730

➤ Please ask for quantity discounts on class sets for 8 pieces and more



STUDENT Kit – Mechanics

Set of apparatus for carrying out 25 basic student experiments on the mechanics of solids, liquids, and gases. In a robust plastic box with foam inserts moulded to the shapes of the items and a transparent lid. The experiments are designed to occupy as little space as possible on the base-plate of the STUDENT Kit basic set (P-1000730), while remaining clear and easy to perform. Includes a CD with instructions for the experiments.

P-1000731

Additionally required:

P-1000730 STUDENT Kit – Basic Kit Set

Contents:

- | | |
|-----------------------------------|---|
| 1 Steel leaf spring | 1 Silicone tube, 500 mm x 3 mm diam. |
| 1 Lever arm | 1 Tubing connector |
| 1 Ruler | 1 Clip, 8 mm diam. |
| 1 Pulley | 1 Clip, 14 mm diam. |
| 1 Pulley with hook | 1 Syringe, 60 ml |
| 1 Weight, 100 g | 1 Syringe, 30 ml |
| 3 Weights, 50 g | 1 Plastic sphere |
| 2 Weights, 25 g | 1 Rubber stopper (30 mm x 31/25 mm diam.) |
| 1 Dynamometer, 2 N | 1 Funnel, 40 mm diam. |
| 1 Metal pivot | 1 U-tube manometer |
| 4 Washer rings to fit metal pivot | 1 Measuring cylinder |
| 1 Pulley with cord | 100 g Modelling clay |
| 1 Trolley | |
| 1 Friction pad | |
| 1 Coil spring | |
| 1 Iron block | |
| 1 Aluminium block | |
| 1 Wooden block | |



Includes 25 Experiments on the Subject of Mechanics:

- Effects of forces
- Action and reaction
- Deformation by forces (2 experiments)
- Masses and densities of bodies
- Friction
- Second class lever
- First class lever (2 experiments)
- Fixed pulley
- Moving pulleys
- Combinations of fixed and moving pulleys (block and tackle)
- Inclined plane (2 experiments)
- Connected vessels
- Pressure in liquids
- Principle of the U-tube manometer
- Pressure due to weight of fluids
- Buoyancy in liquids
- Floating and sinking
- Air as a body
- Pressure and volume
- Temperature and volume
- Effects of atmospheric pressure



First class lever

Equipment Mechanics:

P-1000731 STUDENT Kit – Mechanics

P-1000730 STUDENT Kit – Basic Kit Set

STUDENT Kit – Heat

Set of apparatus for carrying out 10 basic student experiments on heat. In a robust plastic box with foam inserts moulded to the shapes of the items and a transparent lid. The experiments are designed to occupy as little space as possible on the base-plate of the STUDENT Kit basic set (P-1000730), while remaining clear and easy to perform. Includes a CD with instructions for the experiments.

Contents:

- 1 Conical flask, 100 ml
- 1 Bimetallic strip
- 1 Concave mirror mounted on stem
- 1 Aluminium rod 200 mm
- 1 Thermometer, -10°C – $+100^{\circ}\text{C}$
- 1 Glass tube with 90° bend
- 1 Rubber stopper, 25 mm x 24/19 mm diam.
- 1 Spirit burner
- 1 Ceramic mat

P-1000732

Additionally required:

P-1000730 STUDENT Kit – Basic Set

➤ Please ask for quantity discounts on class sets for 8 pieces and more

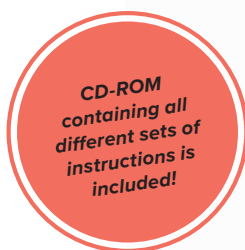

Includes 10 Experiments on the Subject of Heat:

- Principle of a thermometer
- Heating of solid bodies
- Heating of liquid bodies
- Heating of gases
- Behaviour of bimetallic objects
- Conduction of heat
- Radiation of heat
- Condensation
- Distillation
- Temperature of mixtures

Equipment Heat:

P-1000732 STUDENT Kit – Heat

P-1000730 STUDENT Kit – Basic Set



Principle of a thermometer

STUDENT Kit – Optics

Set of apparatus for carrying out 23 basic student experiments in optics. In a robust plastic box with foam inserts moulded to the shapes of the items and a transparent lid. Includes a CD with instructions for the experiments. The experiments are designed to occupy as little space as possible on the included optical bench, while remaining clear and easy to perform.

Contents:

- 2 Lenses, $f = +100$ mm
- 1 Lens, $f = +50$ mm
- 1 Lens, $f = -100$ mm
- 1 Lens, $f = +300$ mm
- 1 Diaphragm holder
- 1 Plug-in power supply unit for optical lights
- 1 Optical light
- 1 Overlay mask protractor
- 1 Projection screen/experiment table
- 1 Optic bench
- 2 Tea lights
- 1 Opaque body
- 1 Single aperture slot
- 1 Triple aperture slot
- 1 Colour slide M-Y-C
- 1 F diaphragm
- 1 Flexible mirror
- 1 Coplanar board
- 1 Semicircular body
- 1 Converging lens
- 1 Diverging lens
- 1 Right-angled prism
- 2 Sheets of graph paper, transparent DIN A5
- 1 Scale



STUDENT Kit Optics (230 V, 50/60 Hz)
P-1000734

STUDENT Kit Optics (115 V, 50/60 Hz)
P-1000733

Includes 23 Experiments on the Subject of Optics:

- Propagation of light
- Light and shadows
- Reflection at a plane mirror
- Concave and convex mirrors
- Refraction of light (2 experiments)
- Refractive index
- Optical lenses (paths of rays)
- Focal point of convergent lenses
- Focal length of convergent lenses
- Formation of images with converging lenses
- Laws of images
- Magnifying glasses
- Function of the eye
- Function of spectacles (2 experiments)
- Principle of a camera
- Principle of a slide projector
- Principle of a Galilean telescope
- Principle of an astronomical telescope
- Principle of a microscope
- Breaking down light into its components
- Mixing of colours

Equipment Optics:

P-1000734 STUDENT Kit – Optics (230 V, 50/60 Hz)
 or
P-1000733 STUDENT Kit – Optics (115 V, 50/60 Hz)



Principle of a slide projector

STUDENT Kit – Electricity

Set of apparatus for carrying out 28 fundamental student experiments on electricity. Stored in a tough Grattells tray with foam inlay featuring recesses moulded to the shape of the apparatus and covered by a transparent lid. Circuits are assembled using components in plug-in housings plugged into a plug-in board. Power is supplied via 2 D-cell, LR20, 1.5 V batteries (batteries not included) or via an external power supply. Includes a CD with instructions for the experiments.

P-1017213



Contents:

- 1 Plug-in Board for Components
- 2 Battery Holders
- 1 Set of Conductors and Non-Conductors
- 1 Set of 10 E10 lamps;
1.3 V, 60 mA
- 1 Set of 10 E10 lamps;
3.8 V, 300 mA
- 3 E10 lamp sockets
- 2 Change-over switches
- 1 Toggle switch, single pole
- 1 Push-button (NO), single pole
- 1 Roll of chrome-nickel wire
- 1 Roll of constantan wire
- 1 Roll of iron wire
- 1 Set of 10 connecting plugs
- 6 Connecting plugs, 4 mm
- 6 Crocodile clips
- 1 Potentiometer, 220 Ω
- 1 Linear Resistor, 47 Ω , 2 W
- 2 Linear Resistors, 100 Ω , 2 W
- 2 Zinc plates
- 2 Copper plates
- 2 Carbon plates
- 1 Glass trough
- 1 Set of 3 experiment leads, red
- 1 Set of 3 experiment leads, blue
- 1 Roll of experiment cord
- 1 Weight, 50 g
- 1 Tea candle

Includes Instructions for 28 Experiments on Electricity:

- Simple electric circuits (2x)
- Electrical conductors and insulators
- Production of heat and light
- Various sources of electricity *
- Conduction in liquids *
- Single-pole change-over switches (SPDT)
- Two-way switches
- Measurement of current in a simple electric circuit **
- Measurement of voltage in a simple electric circuit **
- Incandescent lamps connected in series
- Incandescent lamps connected in parallel
- Terminal voltage and open-circuit (no-load) voltage **
- Batteries connected in series and parallel **
- Battery made from a lemon **
- Relationship between voltage and current determined by varying voltage * / **
- How electrical power depends on other variables in an electric circuit * / **
- How electrical work depends on other variables in an electric circuit * / **
- Ohmic resistance * / **
- How electrical resistance depends on temperature (2x) * / **
- How electrical resistance depends on the length of the wire * / **
- How electrical resistance depends on the cross section of the wire * / **
- How electrical resistance depends on the material of the wire * / **
- Resistivity * / **
- Resistors connected in series * / **
- Resistors connected in parallel * / **
- Variable resistors
- Potentiometers * / **

Equipment Electricity:

P-1017213 STUDENT Kit – Electricity

**P-1021091 AC/DC Power Supply, 0 – 12 V,
3 A (230 V; 50/60 Hz)**

or

**P-1021092 AC/DC Power Supply, 0 – 12 V,
3 A (115 V; 50/60 Hz)**

(for experiments marked *)

P-1013526 Analogue Multimeter ESCOLA 30
(for experiments marked **)

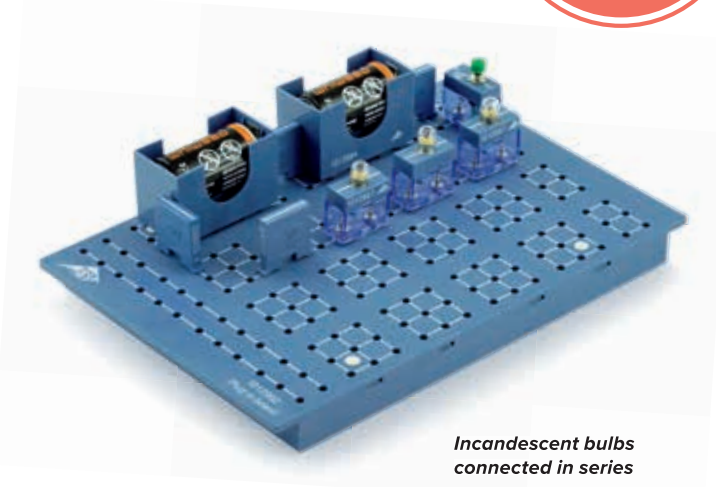

**Incandescent bulbs
connected in series**

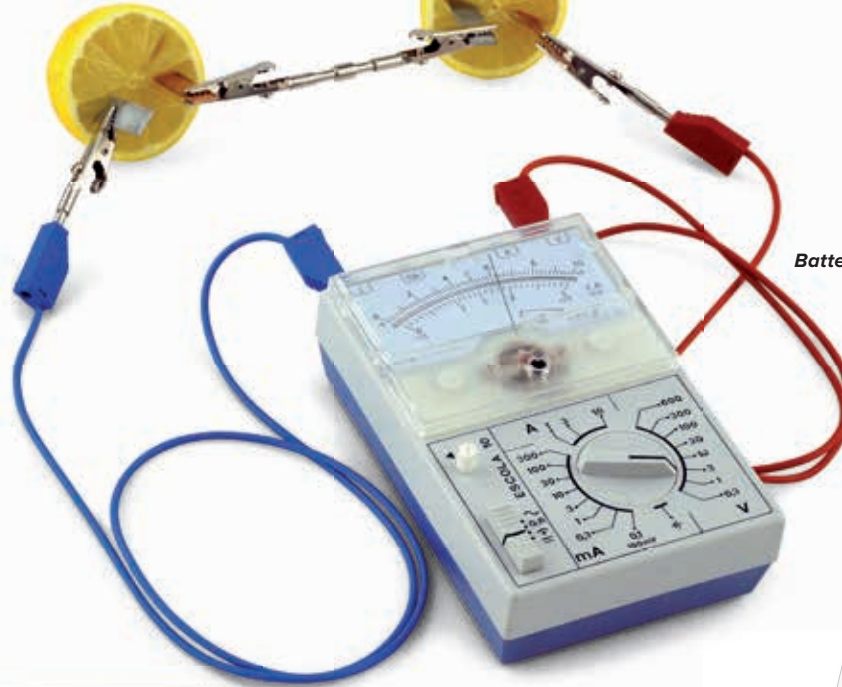

Battery made from a lemon

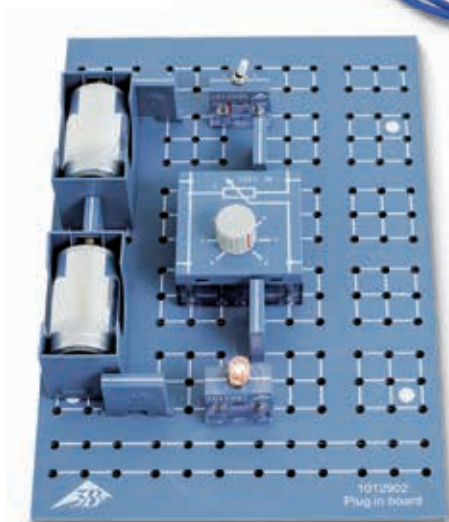

Variable resistors

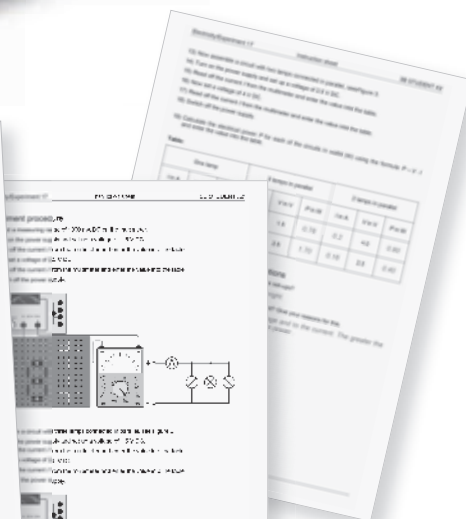
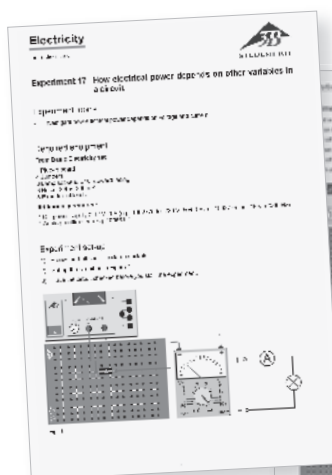

> Please ask for quantity discounts on class sets for 8 pieces and more

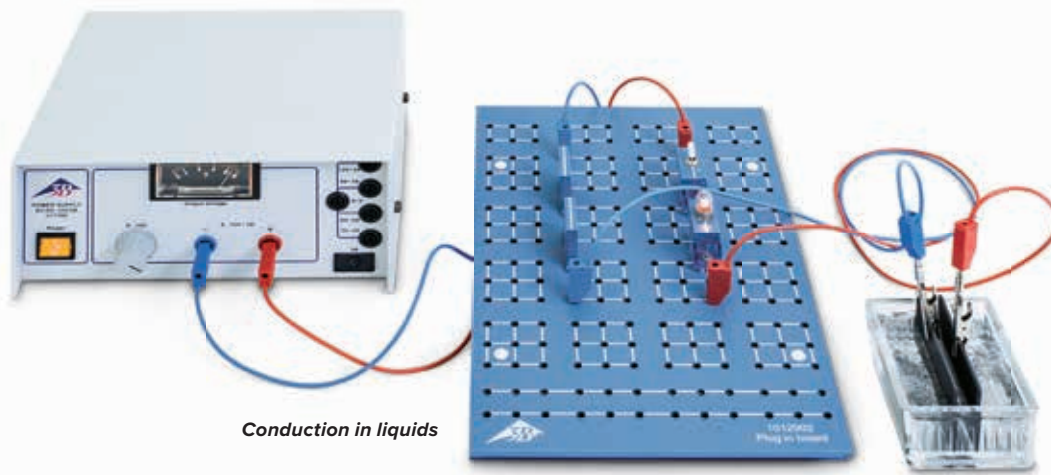

Conduction in liquids

STUDENT Kit – Electrostatics

Set of apparatus for carrying out 15 basic student experiments on electrostatics. Including electroscope, charge indicator, charge storage unit and Piezo charger. In a robust plastic box with foam inserts moulded to the shapes of the items and a transparent lid. Includes a CD with instructions for the experiments. The experiments are designed to occupy as little space as possible in the apparatus frame, while remaining clear and easy to perform.

➤ Please ask for quantity discounts on class sets for 8 pieces and more

Contents:

- 1 Stand base
 - 1 Apparatus frame
 - 2 Aluminium rods
 - 1 Aluminium rod with magnet
 - 1 Electroscope
 - 1 Plastic plate, angled
 - 1 Plastic rod
 - 1 Glass rod
 - 1 Conductor body
 - 1 Set of needles
 - 1 Spinner
 - 1 Pendulum bob (polystyrene)
 - 1 Screw-on needle
 - 1 Set of plasticine
 - 2 Experiment leads
 - 1 Set of balloons
 - 1 Set of papers with 1 plastic cloth
 - 1 Set of metal strips
 - 1 Piezo charger
 - 1 Faraday cage
 - 1 Faraday cup
 - 1 Charge indicator
 - 1 Charge storage unit
 - 2 Capacitor plates
 - 1 Dielectric
- P-1009883**

CD-ROM
containing all
different sets of
instructions is
included!



Includes 15 Experiments on the Subject of Electrostatics:

- Electrostatic charging of hair
- Forces on uncharged particles
- Charge indicator
- Forces between charged bodies
- Build your own electroscope
- Electroscope
- “Shock of hair”
- Demonstrating charge on a capacitor
- “Charge pendulum”
- “Spinner”
- Charging due to induction
- Transfer of charge using a “charge spoon”
- Faraday’s cup
- Faraday’s cage
- Plate capacitor

Equipment Electrostatics:

P-1009883 STUDENT Kit – Electrostatics



“Shock of hair”

Acoustics Kit

Complete set of equipment for carrying out more than 30 student experiments on acoustics. In plastic tray with foam inlay.

Dimensions: approx. 530x375x155 mm³

Weight: approx. 4.5 kg

Contents:

- 1 Monochord, with ruler and musical scale
- 1 Steel string
- 1 Perlon string
- 1 Spring balance on support
- 1 Reed pipe with 8 valves
- 1 Tuning fork with plotter pen, 21 Hz
- 1 Tuning fork, 440 Hz
- 1 Light-metal tuning fork, 1700 Hz
- 1 Pipe
- 1 Variable-length closed air column
- 1 Tuned open air column
- 1 Chladni disc with rod
- 1 Bell dome
- 1 Galton whistle
- 1 Kundt pipe with retaining clip
- 5 g Lycopodium powder in sprinkling cellar
- 1 Metallophone with beater
- 1 Rope for demonstrating waves
- 1 Helmholtz resonator, 70 mm diam.
- 1 Helmholtz resonator, 52 mm diam.
- 1 Helmholtz resonator, 40 mm diam.
- 1 Helmholtz resonator, 32 mm diam.
- 1 Screw clamp
- 1 Plastic block
- 1 Plunger

P-1000816



Experiment Topics:

- Noise, bangs, pure tones
- Vibrating air columns
- Whistles and pipes
- Vibrating bars, plates and bells
- Infra-sound
- Ultra-sound
- Tuning fork with plotter pen
- Travelling waves along a rope
- Velocity of propagation of sound
- Moving sources of sound (Doppler effect)
- Plate vibrations (Chladni figures)
- Vibrations of a bell
- Standing waves on a rope, overtones
- Sounds of musical instruments
- Representation of oscillations with a tuning fork with plotter pen
- Timbre of the human voice
- Measurement of wavelength (Kundt figures)
- Resonance
- Helmholtz ball resonators
- Sound analysis
- Loudness
- Pitch of string instruments
- Pitch of wind instruments
- Reed pipe
- C-major scale and its intervals
- Triads, harmonies
- Semitones, major and minor

Representation of oscillations with a tuning fork with plotter pen

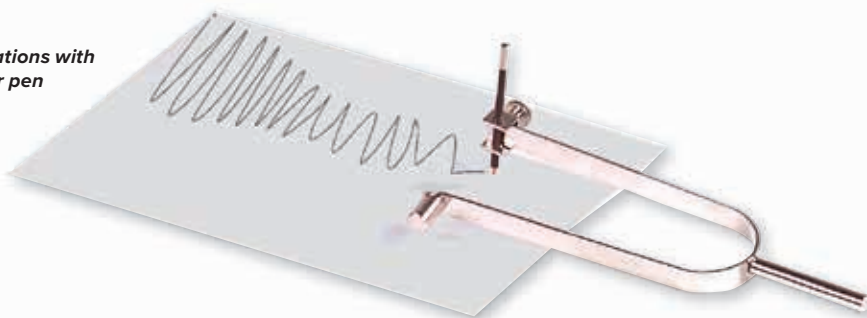

The acoustics kit allows students to carry out numerous experiments on acoustics independently. A wide variety of sound sources are studied to begin with and the concepts of noise, bangs and tones as well as pitch and loudness are investigated. Waves along a rope are used to illustrate harmonic vibrations and overtones. There is also some extensive study of various different musical instruments. Different high-pitched tones are generated by means of a monochord and the ensuing intervals are calculated experimentally. These studies are expanded to other instruments and can easily lead over to a study of musical notes.

Student Experiment Kits (SEK)

With the comprehensive and practical student experiment kits students can independently carry out numerous experiments on mechanics, heat, optics, electricity and magnetism, solar energy, oscillations and waves, or radioactivity. To help them there are detailed instructions for all the experiments. Each of the experiments only requires a small amount of space, but nevertheless an easily understood and stable set-up is always assured. The prescribed layouts for the experiment set-ups make it possible for teachers to quickly assess the progress and success achieved by individual students conducting the experiments.

SEK Mechanics

Set of equipment for carrying out 23 student experiments on the mechanics of solids. In a tough plastic box containing a foam insert with cut-outs for the equipment and featuring a transparent lid. Includes CD with experiment instructions. Experiments are set up and performed on the SEK base plate (P-1000789) so that they are compact but still clear in their layout and objectives.

P-1008527



Includes 23 Experiments on the Subject of Mechanics:

- Hooke's law
- Calibrating a dynamometer
- Deformation of a leaf spring
- Addition of forces acting along the same line
- Resolution of a force into two components
- Investigation of inertia
- Types of friction
- Laws of static and kinetic friction
- Equilibrium conditions for a first-class lever
- Equilibrium conditions for second and third-class levers
- Forces, paths and work with fixed pulleys
- Forces, paths and work with non-fixed pulleys
- Forces, paths and work with block and tackle
- Forces, paths and work with multiple pulleys
- Forces on an inclined plane
- Determining the volume of solid bodies
- Determining the mass of solid bodies (beam balance)
- Determination of density
- Determining the nature of a material by measuring density

- Specific weight and buoyancy
- Period of a string pendulum
- Determining gravitational acceleration with the aid of a string pendulum
- Period of a spring oscillator

Equipment mechanics:

P-1008527 SEK Mechanics

P-1000789 SEK Base Plate

Contents:

- 2 Stand rods with external and internal thread, 400 mm
- 1 Stand rod with external thread, 400 mm
- 2 Stand rods, 110 mm
- 2 Double clamps
- 1 Beam balance
- 2 Weighing pans with holders
- 1 Scale for balance
- 1 Axle rod for pulleys
- 1 Rolling pin with add-on weights
- 1 Block and tackle with two pulleys and two hooks
- 1 Block and tackle with two pulleys and one hook
- 1 Multiple pulley
- 1 Plastic pulley, 40 mm
- 4 Weights, 25 g
- 1 Weight, 50 g
- 1 Weight, 100 g
- 1 Magnetic base
- 1 Adjustable bracket
- 2 S-shaped hooks, 1 g
- 2 S-shaped hooks, 2 g
- 2 S-shaped hooks, 5 g
- 4 O-rings
- 1 Body for friction and inertia experiments
- 1 Set of plastic strips for friction experiment
- 1 Dynamometer 1 N
- 1 Dynamometer 2 N
- 1 Leaf spring, 330 mm
- 1 Coil spring with 2 eyelets, approx. 5 N/m 100 m of twine
- 2 Pointers
- 1 Measuring cylinder
- 1 Stand base for measuring cylinder
- 3 Strips of velour paper
- 1 Set square
- 1 Ruler

➤ Please ask for quantity discounts on class sets for 8 pieces and more

SEK Base Plate

Tilt-resistant stainless-steel base with five special threads for the tilt-free insertion of stand rods, threads for mounting a dismantling transformer and numerous expansion slots for the insertion of electrical components.

With stable and nonslip rubber feet.

Dimensions: approx. 400x245x15 mm³

P-1000789

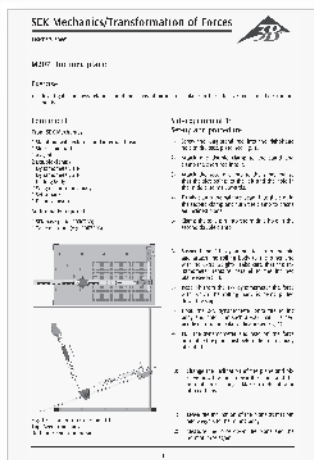
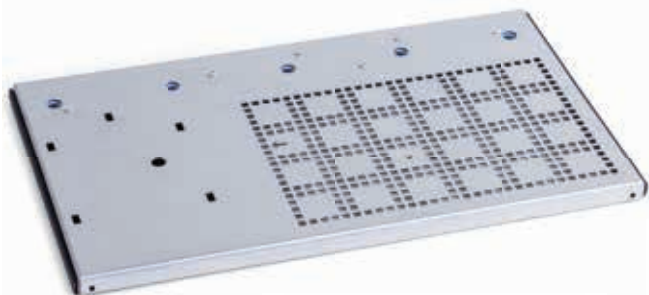

Block and tackle



Hooke's law

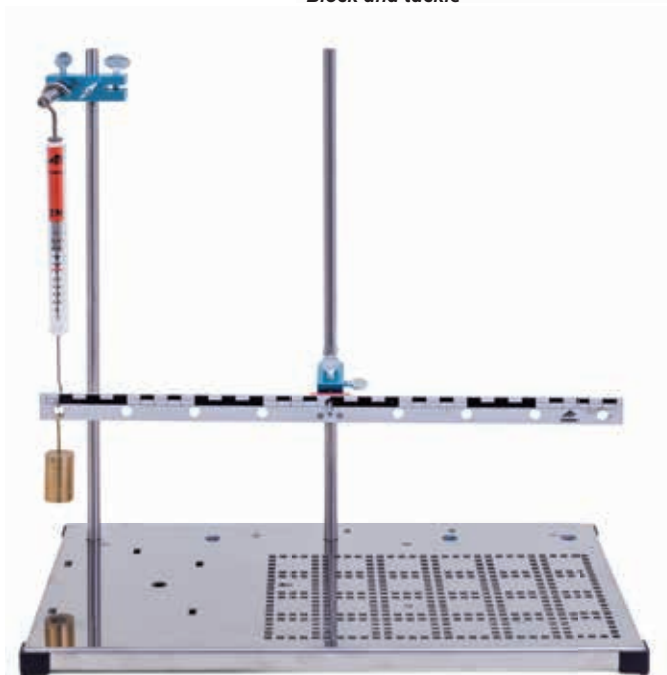

Second and third-class levers

SEK Heat

Set of equipment for carrying out 22 basic student experiments on heat. In a tough plastic box containing a foam insert with cut-outs for the equipment and featuring a transparent lid. Includes CD with experiment instructions. Experiments are set up and performed on the SEK base plate (P-1000789) so that they are compact but still clear in their layout and objectives.

P-1008528



Includes 22 Experiments on the Subject of Heat:

- Change in the volume of liquids due to heating
- Calibration of a thermometer
- Change in the volume of air due to changes in temperature
- Changes in state of an enclosed volume of air
- Changes in the length of solid bodies when heated
- Linear expansion coefficient
- Investigations using bimetal strips
- Transfer of heat in solid bodies
- Transfer of heat in liquids
- Transfer of heat in gases
- Radiation of heat
- Slowing down the transport of heat
- Temperature changes when liquids are heated
- Fundamental equation of thermodynamics
- Mixing water of differing temperatures, temperature of mixture
- Specific heat capacity of a calorimeter
- Specific heat capacity of metals
- Initial temperature of a metal body heated in a flame
- Conversion of electrical energy into heat
- Temperature changes when ice melts
- Specific latent heat of melting ice
- Boiling and condensation of water
- Distillation
- Evaporation of liquids (what it depends on and heat loss due to evaporation)

Equipment Heat:

P-1008528 SEK Heat

P-1000789 SEK Base Plate

Contents:

- 1 Stand rod with internal and external threads, 400 mm
- 4 Wooden rods
- 1 Metal tube, short
- 1 Pointer/hook
- 1 Stirrer
- 1 Steel tube
- 1 Brass tube
- 1 Aluminium tube
- 1 Thermometer without scale, red liquid
- 2 Thermometers, -10 – 110°C, 1 K, red liquid
- 1 Capillary tube
- 1 Bimetal strip with 10-mm stub
- 10 Round filters
- 10 Sheets of thermal paper
- 1 Steel body
- 1 Lead body
- 1 Spirit burner
- 1 Beaker, 100 ml
- 1 Conical flask, 100 ml
- 1 Test tube holder with rod attachment
- 1 Test tube
- 1 Measuring cylinder, 50 ml
- 1 Calorimeter with heating filament, 200 ml
- 1 Rubber stopper with two holes
- 2 Rubber stoppers with one hole
- 1 10 g weight with hook
- 2 Double clamp
- 1 Bottle of food colouring plus pipette
- 10 g of table salt
- 1 Holder for metal beaker
- 1 Metal beaker, black
- 1 Metal beaker, aluminium
- 4 g of glycerine
- 1 Hose
- 2 Round gaskets
- 1 Angle scale
- 10 Sheets of paper
- 5 Sheets of aluminium foil

➤ Please ask for quantity discounts on class sets for 8 pieces and more



Changes in the length of solid bodies when heated

CD-ROM
containing all
different sets of
instructions is
included!

Thermodynamics	Topic	Page
1. Properties of Solids	1.1. Thermal Expansion	21
2. Properties of Solids	2.1. Thermal Expansion	21
3. Properties of Solids	3.1. Thermal Expansion	21
4. Properties of Solids	4.1. Thermal Expansion	21
5. Properties of Solids	5.1. Thermal Expansion	21
6. Properties of Solids	6.1. Thermal Expansion	21
7. Properties of Solids	7.1. Thermal Expansion	21
8. Properties of Solids	8.1. Thermal Expansion	21
9. Properties of Solids	9.1. Thermal Expansion	21
10. Properties of Solids	10.1. Thermal Expansion	21

Thermodynamics	Topic	Page
1. Properties of Solids	1.1. Thermal Expansion	21
2. Properties of Solids	2.1. Thermal Expansion	21
3. Properties of Solids	3.1. Thermal Expansion	21
4. Properties of Solids	4.1. Thermal Expansion	21
5. Properties of Solids	5.1. Thermal Expansion	21
6. Properties of Solids	6.1. Thermal Expansion	21
7. Properties of Solids	7.1. Thermal Expansion	21
8. Properties of Solids	8.1. Thermal Expansion	21
9. Properties of Solids	9.1. Thermal Expansion	21
10. Properties of Solids	10.1. Thermal Expansion	21

SEK Thermodynamics/Heat transfer

K205 Investigation of the transfer of heat

Form:

1. Aim of the experiment is to study the transfer of heat.

Background:

Heat is a form of energy which is transferred from one body to another body when there is a temperature difference between them.

Equipment:

1. Bunsen burner, 2. Spirit lamp, 3. Thermometer, 4. Beaker, 5. Water, 6. Metal blocks, 7. Stopwatch, 8. Stand, 9. Clamps, 10. Ruler.

Procedure:

1. Heat the water in the beaker by the Bunsen burner.

2. Measure the temperature of the water at regular intervals.

3. Record the temperature of the water in the table.

4. Repeat the experiment for different metal blocks.

5. Compare the results.

Diagram:

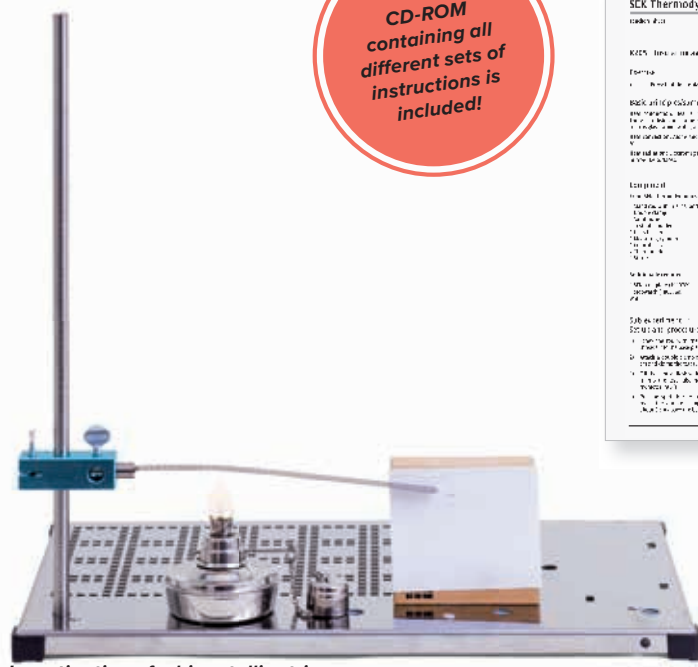

Investigation of a bi-metallic strip

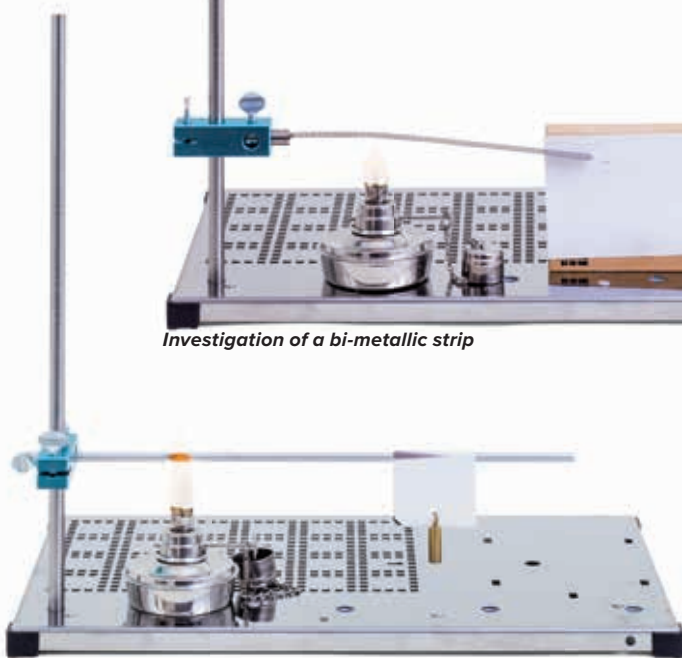

Heat transfer in solid bodies



Specific heat capacity of metals

Thermodynamics/K205 Teachers' sheet SEK

Complete the following:

A Dewar vessel (Thermos flask) is designed to reduce all three kinds of heat transfer to a minimum (heat insulation).

- The mirrored surface of the double-walled glass vessel insulates against much of the heat radiation.
- The partial vacuum inside the double-walled vessel and the insulating layer between the vessel and its lid suppress most of the heat convection and conduction.
- The calorimeter is therefore insulated against losing heat to the surroundings.
- A thermos flask keeps hot things hot and cold things cold for longer.

Give reasons for the following:

- Refrigerated trailers (as used on trains) are painted white or silver.
Heat radiation is then reflected away instead of being absorbed.
- The handles of most saucepans are made of plastic.
The plastics used for such handles are poor conductors.
- Foam is good at insulating heat.
This is because the many bubbles of air prevent both conduction and convection of heat.

SEK Electricity and Magnetism

Set of equipment for carrying out 41 student experiments on electricity and magnetism. In a tough plastic box containing a foam insert with cut-outs for the equipment and featuring a transparent lid. Includes CD with experiment instructions. The experiments are set up and performed in a space saving fashion but are still clearly laid out on the SEK base plate (P-1000789).

P-1008532



➤ Please ask for quantity discounts on class sets for 8 pieces and more

Includes 41 Experiments on the Subject of Electricity and Magnetism:

- Closed circuits
- Conductors and insulators
- Circuits with no branches
- Circuits with branches
- Current in a circuit with no branches
- Current in a circuit with branches
- Initial voltage and terminal voltages
- Voltage in a circuit with no branches
- Voltage in a circuit with branches
- Voltage dividers
- Ohm's law
- Temperature dependence of a resistor (iron wire)
- Current-voltage diagram for a light bulb
- Current-voltage diagram for a thermistor
- Law of resistance
- Resistance in a circuit with no branches
- Resistance in a circuit with branches
- Resistance and voltage in a circuit with no branches
- Resistance and current in a circuit with branches
- Voltage dividers with and without a load
- Voltage-time diagram for charging and discharging of a capacitor
- Current-time diagram for charging and discharging of a capacitor
- Relationship between charge and voltage
- Capacitor in the DC and AC circuit (response)
- Test bodies in a magnetic field
- Magnetic poles
- Magnetic field of a horseshoe magnet and a bar magnet
- Magnetic dipoles
- A coil used as a magnet
- Forces in the magnetic field of a coil
- Induction due to relative motion

Contents:

- 1 Set of experiment leads
- 1 Bar magnet, 65x16x5 mm approx.
- 1 Horseshoe magnet, ALNICO, flat
- 1 Resistor board
- 1 Transformer core, 20x20 mm
- 1 Tightening screw
- 1 Coil, 200/400/600 windings
- 1 Coil, 400/400/800 windings
- 2 Current branches (plug-in components)
- 1 Potentiometer, 100 Ω (plug-in component)
- 1 Switch (plug-in component)
- 1 Capacitor, 4700 μF (plug-in component)
- 1 Capacitor, 10 μF (plug-in component)
- 1 Resistor, 33 Ω (plug-in component)
- 1 Resistor, 47 Ω (plug-in component)
- 1 Resistor, 1 k Ω (plug-in component)
- 1 NTC-resistor, 100 Ω (plug-in component)
- 2 Lamp sockets, E10 (plug-in components)
- 1 Storage box with 1 set of threads with washer, 2 threaded bushes, 2 threaded pins, 2 Paper clips, 2 aluminium electrodes, constantan wire
- 50 g of iron filings
- 50 m of chrome/nickel wire, 0.2 mm
- 50 m of iron wire, 0.2 mm
- 1 Tea candle



Transformer under load

- Induction due to changes in magnetic field
- Induction law
- Ohmic resistance in AC and DC circuits
- Capacitors in AC and DC circuits (resistance)
- Coils in AC and DC circuits
- How a transformer works
- Voltage and number of windings for a transformer with no load
- Transformer under load
- Transformer under heavy load
- Thermoelectricity

Equipment Electricity:

P-1008532 SEK Electricity and Magnetism

P-1000789 SEK Base Plate

P-1013526 Analogue Multimeter ESCOLA 30

P-1021686 SEK Power Supply (230 V, 50/60 Hz)

or

P-1021687 SEK Power Supply (115 V, 50/60 Hz)

SEK Power Supply

AC/DC power supply for SEK electricity and magnetism kit (P-1008532).

- Voltage limitation to 25 V AC and 60 V DC
 - Safety transformer conforming to EN 61558-2-6
 - Safe isolation between power supply and output circuits
- Voltages: 1.5/ 3.0/ 4.5/ 6.0 V AC/DC



SEK Power Supply (230 V, 50/60 Hz)
P-1021686

SEK Power Supply (115 V, 50/60 Hz)
P-1021687

CD-ROM containing all different sets of instructions is included!

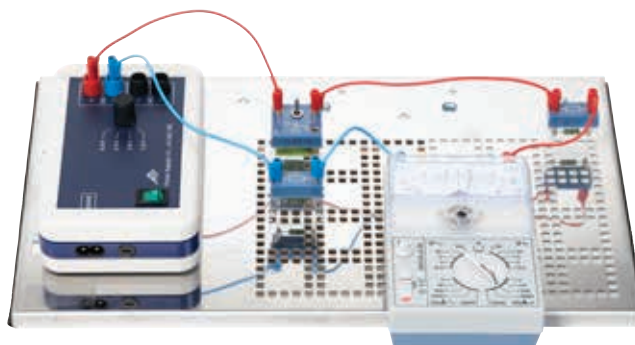

Electric current in circuits with no branches

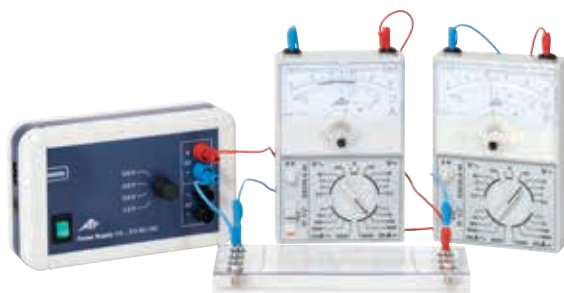

Laws of resistance

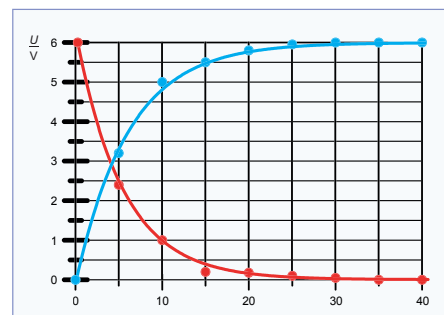

Capacitor: charging (blue) and discharging (red)

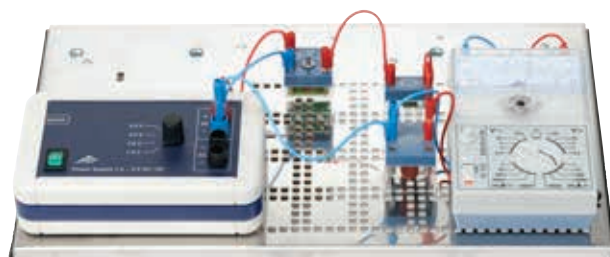

Charging and discharging of a capacitor (voltage)

➤ Please ask for quantity discounts on class sets for 8 pieces and more

CD-ROM
containing all
different sets of
instructions is
included!



SEK - Electronics

Set of apparatus for carrying out 11 fundamental student experiments on electronics. Stored in a tough Gragnell tray with foam inlay featuring recesses moulded to the shape of the apparatus and covered by a transparent lid. Circuits are assembled using components in plug-in housings plugged into a plug-in board. Power is supplied via an external power supply. Includes a CD with instructions for the experiments.

P-1021672

Contents:

1 Set of 10 Jumpers
 1 Resistor 100 Ω , 2W
 1 Resistor 470 Ω , 2 W
 1 Resistor 1 k Ω , 2 W
 1 Resistor 4.7 k Ω
 1 Resistor 10 k Ω , 0.5 W
 1 Resistor 47 k Ω , 0.5 W
 1 Electrolytic Capacitor 100 μ F, 35 V
 1 Electrolytic Capacitor 470 μ F, 16 V
 1 E 10 Socket, socket upward facing
 1 Set of 10 bulbs, 12 V; 100 mA
 1 Set of 10 bulbs, 4 V; 40 mA
 1 Single-Pole Rocker Switch
 1 Single-Pole Push-Button Switches, normally open
 1 Single-Pole Push-Button Switches, normally closed
 4 Si-Diodes 1N 4007
 1 Ge-Diode
 1 Zener Diode ZPD 6.2
 1 LED green
 1 LED, red
 1 LDR 05 Photoresistor
 1 NTC Thermistor 2.2 k Ω
 1 PTC Thermistor 100 Ω
 1 Potentiometer 220 Ω , 3 W
 1 NPN Transistor BD 137
 1 PNP Transistor BD 138
 1 BF 244 Field Effect Transistor
 1 TYN 1012 Thyristor
 1 Single-Pole Change-Over Switch
 1 Set of earpiece headphones

Includes instructions for 11 experiments on electronics:

- Characteristics of a semiconductor diode
- Characteristic of an LED
- Characteristic of a zener diode
- Check how current flows through a transistor
- Characteristics of a transistor
- LDR photoresistor (light dependent resistor)
- Thyristors in DC circuits
- Temperature response of NTC and PTC thermistors
- Delayed switching processes
- Characteristics of a field effect transistor
- Check for mains hum

Equipment electronics:

P-1021672 SEK - Electronics

P-1012902 Plug-in Board for Components

P-1021091 AC/DC Power Supply, 0 - 12 V, 3 A (230 V; 50/60 Hz)

or

P-1021092 AC/DC Power Supply, 0 - 12 V, 3 A (115 V; 50/60 Hz)

P-1013526 Analogue Multimeter 30 (2x)

P-1002840 Set of 15 Experiment Leads, 75 cm

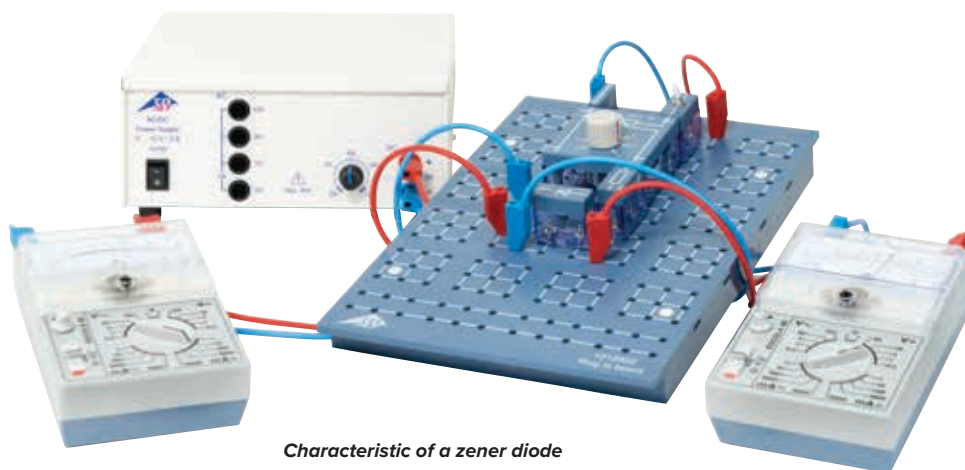

Characteristic of a zener diode

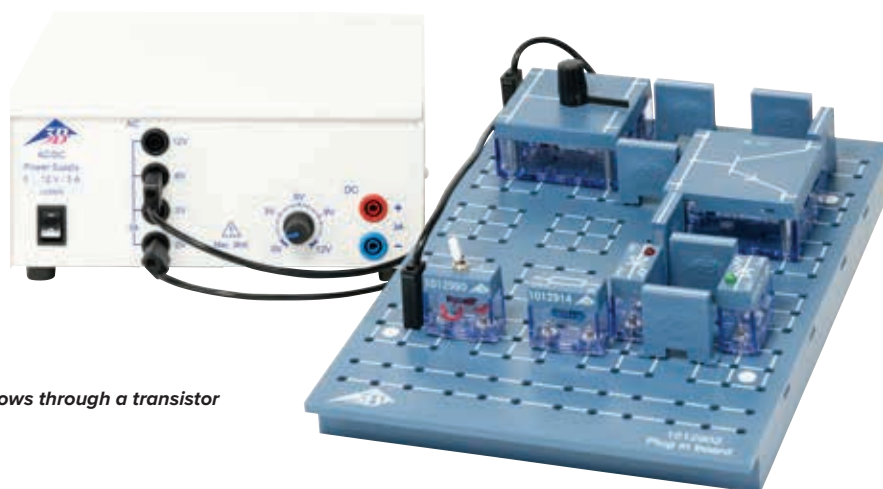

Check how current flows through a transistor



Thyristors in DC circuits

SEK Optics

Set of equipment for carrying out 38 student experiments on ray optics. In a tough plastic box containing a foam insert with cut-outs for the equipment and featuring a transparent lid. Includes CD with experiment instructions. The experiments are designed to be compact but still easy to see when set up and carried out on the supplied optical bench or the SEK base plate (P-1000789). In both cases, the optical components are attached in non-slip fashion by magnets. Supplied overlays designate where the components are to be placed.

SEK Optics (230 V, 50/60 Hz) P-1008531

SEK Optics (115 V, 50/60 Hz) P-1008530

Contents:

- | | |
|---|-------------------------------------|
| 1 Optical bench | 1 Semi-circular body |
| 1 Optical lamp, 5 V, 2 W | 1 Diverging lens, flat model |
| 1 Plug-in power supply, 100 – 240 V, 50/60 Hz | 1 Converging lens, flat model |
| 4 Tea candles | 1 Right-angled prism |
| 1 Plastic container | 1 Rectangular block |
| 1 Slide holder, magnetic | 1 Objects for casting shadows |
| 1 F-shaped slide | 1 Flexible mirror, magnetic |
| 1 Slide with triple and quintuple slits | 1 Projection screen/Experimenttable |
| 1 Slide with single slit | 2 Lenses, $f = +50$ mm |
| 1 Object for use as an image | 1 Lens, $f = +100$ mm |
| 1 Colour filter, red | 1 Lens, $f = +300$ mm |
| 1 Colour filter, blue | 1 Lens, $f = -100$ mm |
| 1 Acrylic block with holder | 1 Set of overlays |



CD-ROM
containing all
different sets of
instructions is
included!

Includes 38 Experiments on the Subject of Optics:

- Propagation of light, light beams and rays
- Transparency
- Light and shadow
- Umbra and penumbra
- Reflection from a plane mirror
- Concentration of light by a concave mirror
- Reflection and path of light for a concave mirror
- Reflection and path of light for a convex mirror
- Characteristics of the image from a plane mirror
- When light passes from air into glass / Determination of refractive index
- When light passes from glass into air / Determination of refractive index
- Determination of critical angle for total internal reflection (glass to air)
- Ray diagrams for a rectangular glass block, laws
- Ray diagrams for a glass prism
- Total internal reflection inside a prism
- Path of light through a converging lens
- Determination of focal length for a converging lens
- Ray diagrams with parallel ray and ray through centre of lens (converging lens)
- Path of light through a diverging lens
- Determination of focal length for a diverging lens
- Ray diagrams with parallel ray and ray through centre of lens (converging lens)
- Path of light through a system of lenses
- Image properties (converging lens)
- Image magnification and the lens equation

- Image aberrations with converging lenses
- Formation of images in the eye
- Short-sightedness
- Long-sightedness
- Astigmatism
- Cameras
- Slide projectors
- Microscopes
- Galileo telescope
- Kepler's telescope
- Terrestrial telescope
- Separation of light into a spectrum
- Recomposition of spectral colours
- Additive mixing of colours, complementary colours

Equipment Optics:

P-1008531 SEK Optics (230 V, 50/60 Hz)

or

P-1008530 SEK Optics (115 V, 50/60 Hz)



Reflection and path of light for a convex mirror

> Please ask for quantity discounts on class sets for 8 pieces and more



Reflection in a plane mirror



Path of beams through a glass prism



Model microscope

SEK Mechanical Oscillations and Waves

Large equipment set for carrying out 23 fundamental experiments on the properties of mechanical oscillations and waves. Stored in a tough Grattell tray with foam inlay featuring recesses moulded to the shape of the apparatus and covered by a transparent lid. Includes CD with experiment instructions.

SEK Mechanical Oscillations and Waves (230 V, 50/60 Hz) P-1016652

SEK Mechanical Oscillations and Waves (115 V, 50/60 Hz) P-1018476

Contents:

1 MEC control unit	1 Magnetic hooks
1 Plug-in power supply	1 Bar magnet
2 Dynamic force sensors	1 Rubber cord
1 Eccentric axle motor	1 Roll of twine
1 Induction coil	1 Thread eyelet
1 Stopwatch	1 Squirrel cage ring
4 Coil springs	1 Ruler
1 Set of 10 weights, 50 g	2 BNC cable, 1 m
1 Base plate	1 BNC/4-mm cable
1 Cross-strut	
2 Stand rods with external threads	
2 Stand rods with external and internal threads	
2 Double clamps	

➤ Please ask for quantity discounts on class sets for 8 pieces and more



Includes Instruction for 23 Experiments on Mechanical Oscillations and Waves:

- Determining spring constants (2x)
- Oscillations of a spring pendulum *
- Oscillations of two "identical" spring pendulums * / **
- In-phase and 180° out-of-phase oscillations of two "identical" spring pendulums * / **
- Excitation of a motionless spring pendulum by a moving one * / **
- Superposition of the oscillations of two spring pendulums * / **
- Spring pendulums connected in line * / **
- Spring pendulums connected parallel to one another * / **
- Intrinsic oscillation of a spring pendulum *
- Types of oscillation for a coil spring pendulum *
- String pendulums (2x)
- Seconds pendulums
- Galileo's interrupted pendulum
- Damped oscillations of string pendulums (2x) *
- Standing waves along a rope (2x) *
- Reflection of waves along a rope *
- Speed of propagation of waves along a rope (2x) *
- Oscillation of strings *

Equipment Mechanical Oscillations and Waves:

P-1016652 SEK Mechanical Oscillations and Waves (230 V, 50/60 Hz)
or
P-1018476 SEK Mechanical Oscillations and Waves (115 V, 50/60 Hz)

Dual-channel Oscilloscope, e.g.

P-1020910 Digital Oscilloscope 2x30 MHz
(for experiments marked *)

P-1013526 Analogue Multimeter ESCOLA 30
(for experiments marked **)

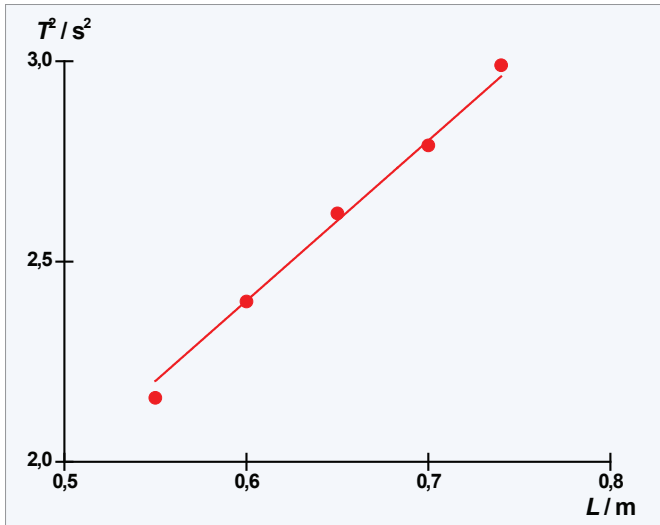

Squares of the period as a function of the length of the pendulum

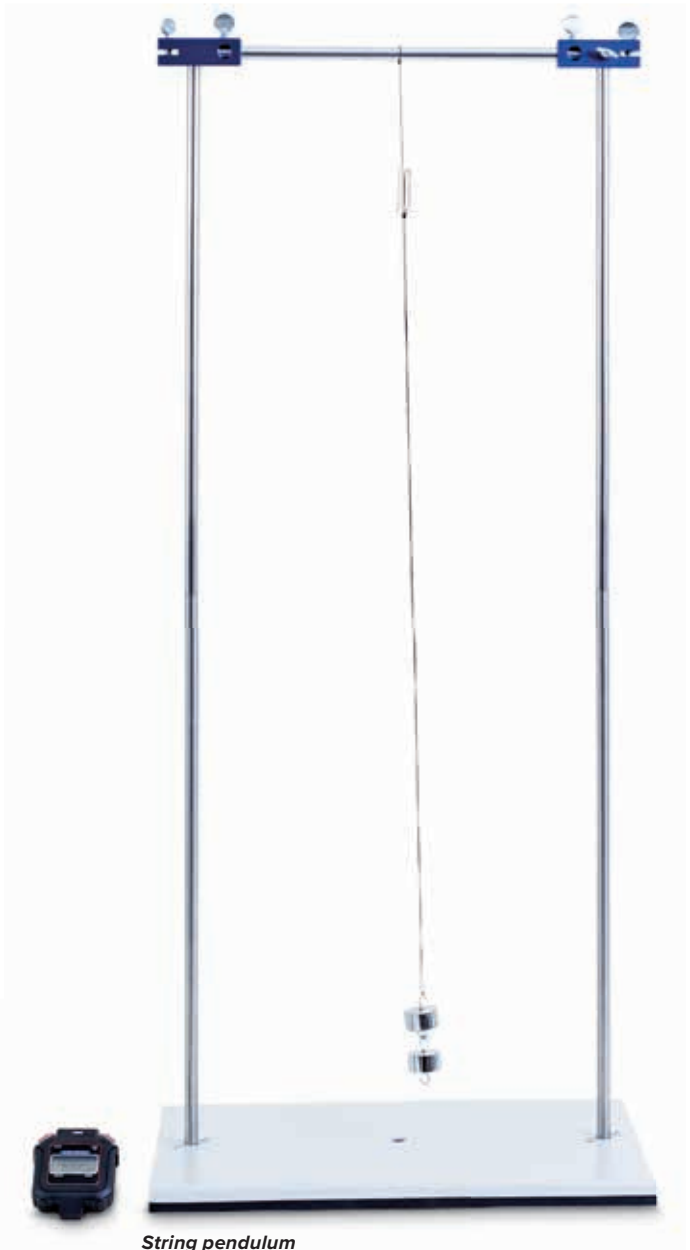

String pendulum

CD-ROM
containing all
different sets of
instructions is
included!

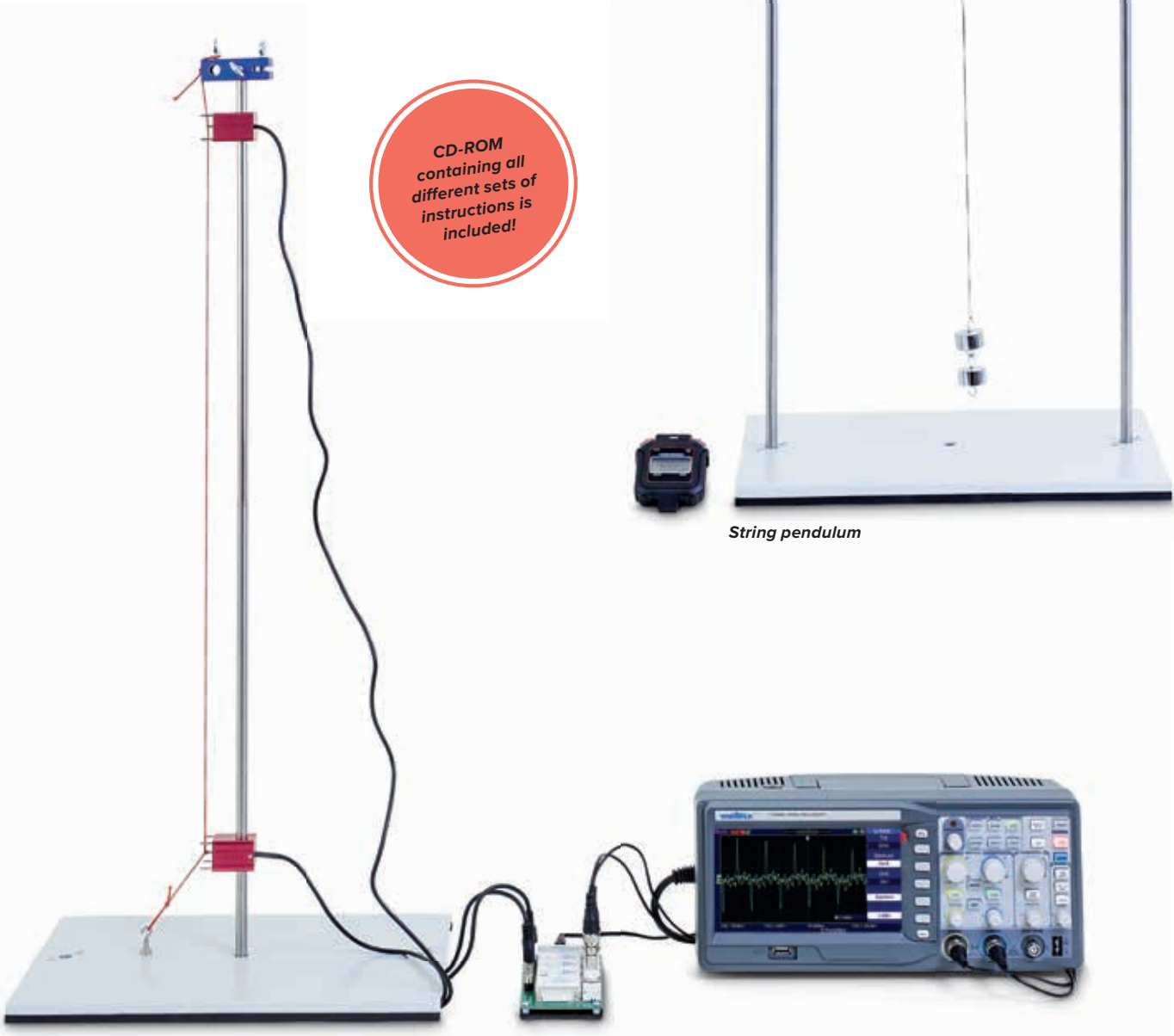

Reflection of waves along a rope

SEK – Ultrasonic Waves

Large equipment set incorporating 30 student experiments for demonstrating the fundamental properties of waves using the example of 40 kHz ultrasonic waves. Stored in a tough Gragnell tray with foam inlay featuring recesses moulded to the shape of the apparatus and covered by a transparent lid. Includes CD with experiment instructions. Includes two ultrasonic transmitters, a rod-shaped microphone sensor for recording and analysing oscillations using a standard oscilloscope and an ultrasonic pen for recording wave fronts along the desktop in the form of lines of the same phase (isophases). Many of the experiments can also be carried out without using an oscilloscope. In order to measure ultrasonic amplitudes, it is sufficient in many cases to use an analogue voltmeter for alternating current if it has a wide enough frequency range.

Contents:

- 1 Ultrasonic control unit
- 2 Ultrasonic transmitters, 40 kHz
- 1 Ultrasonic pen
- 1 Holder for ultrasonic pen
- 1 Holder base for ultrasonic pen
- 1 Microphone probe
- 2 Beam splitters
- 3 Clamps for beam splitters
- 1 Fresnel zone plate
- 1 Concave mirrors
- 2 Side pieces for double slit/reflectors
- 1 Centre post for double slit
- 1 Clap for double slit
- 1 Ultrasonic absorber
- 2 BNC cables, 1 m
- 1 Cable, BNC/4-mm
- 1 Plug-in power supply

SEK – Ultrasonic Waves (230 V, 50/60 Hz)
P-1016651

SEK – Ultrasonic Waves (115 V, 50/60 Hz)
P-1014529

➤ Please ask for quantity discounts on class sets for 8 pieces and more

Includes Instruction for 30 Experiments on Ultrasonic Waves:

- Display of sound oscillations on an oscilloscope *
- Relationship between oscillations and waves *
- Comparison of oscillations at two points along a wave *
- Analysis of phase relationships using an ultrasonic "pen" *
- Determination of wavelength and velocity of sound
- How velocity of sound depends on temperature
- Transmission characteristic of ultrasonic transmitters **
- Resonance curve for ultrasonic transducers *
- Transmission and reflection of ultrasonic waves **
- Absorption of ultrasonic waves **
- Superimposition of sinusoidal oscillations *
- Constructive and destructive reinforcement when sinusoidal oscillations are superimposed *
- Recording of wave fronts using ultrasonic pen
- Generation and detection of straight wave fronts
- Diffraction of ultrasonic waves by an edge
- Diffraction of ultrasonic waves by a single slit
- Interference between two beams **
- Law of reciprocity for interference between two beams **
- Diffraction by a double slit **
- Phase relationships for diffraction by a double slit I *
- Phase relationships for diffraction by a double slit I **
- Formation of images by a spherical concave mirror **
- Plotting of Fresnel zones **
- Formation of images by a Fresnel zone plate **
- Interference of ultrasonic waves by Lloyd's mirror **
- Design of a simple interferometer **
- Design of a Michelson interferometer **
- Elimination of interference by interrupting the path *
- Generation of standing ultrasonic waves **
- Beats in ultrasonic waves *
- Doppler effect in ultrasonic waves



CD-ROM containing all different sets of instructions is included!



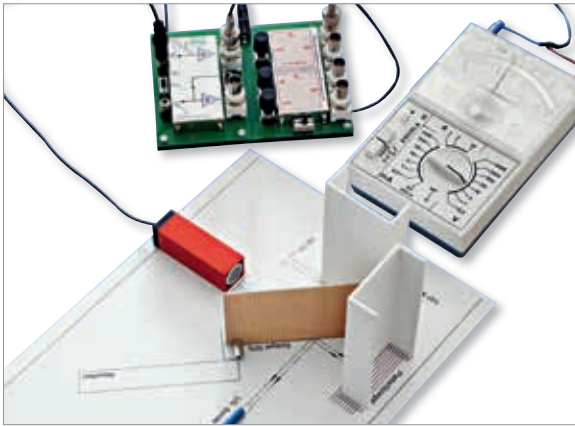

Michelson Interferometer

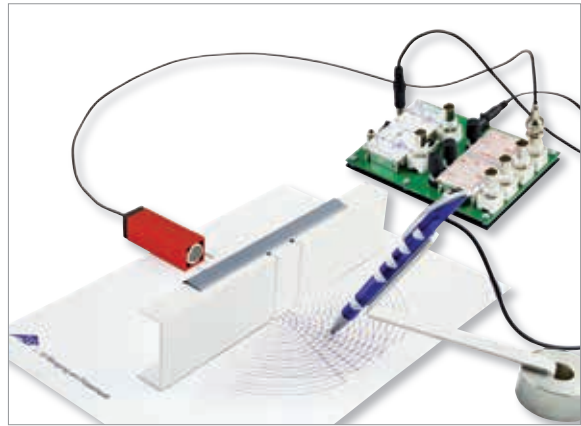

Diffraction by a double slit

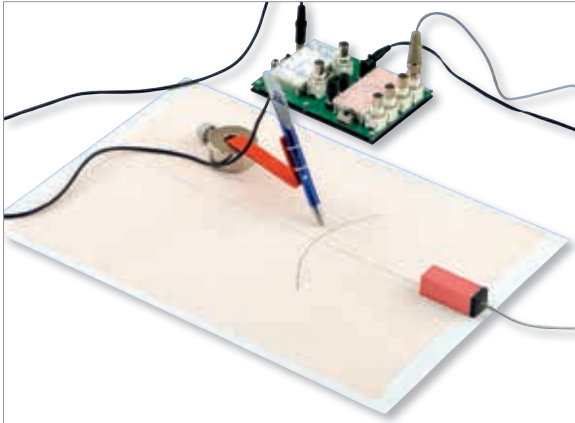

Recording of wave front

Equipment Ultrasonic Waves:
P-1016651 SEK Ultrasonic Waves (230 V, 50/60 Hz)
 or
P-1014529 SEK Ultrasonic Waves (115 V, 50/60 Hz)

Dual-channel Oscilloscope, e.g.
P-1020857 PC Oscilloscope, 2x25 MHz
 (for experiments marked **)

P-1013526 Analogue Multimeter ESCOLA 30
 (for experiments marked **)

Additionally required when using an analogue voltmeter which is unsuitable for measuring alternating voltages of frequencies up to 40 kHz:

P-1018750 Ultrasonic Adapter Lead

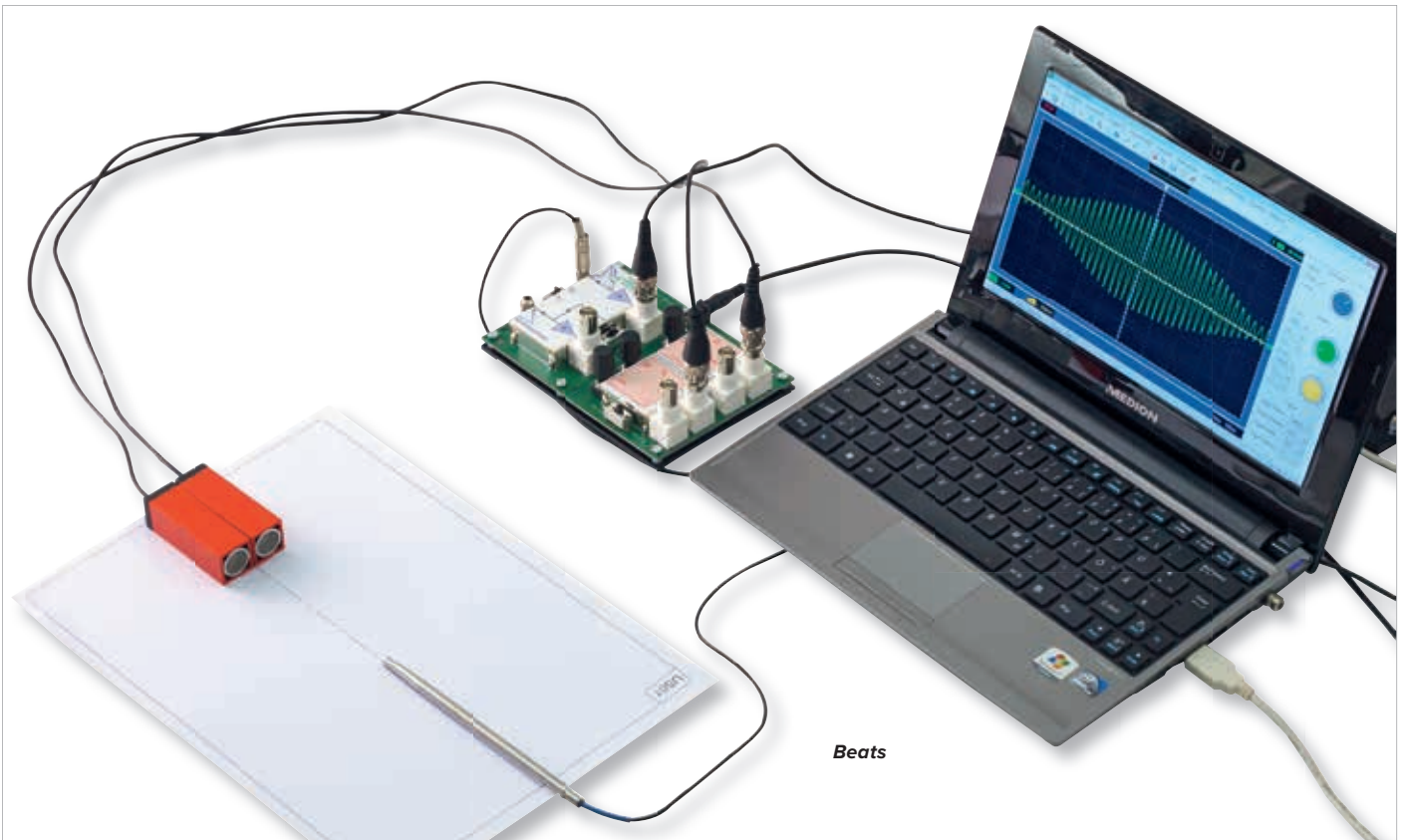

Beats

SEK Radioactivity

Set of apparatus for carrying out 10 basic student experiments on radioactivity. In a robust plastic box with foam inserts moulded to the shapes of the items and a transparent lid. Includes a CD with instructions for the experiments. The experiments are designed to occupy as little space as possible on the supplied base plate, while remaining clear and easy to perform. To determine the count rates, it is recommended that a GAMMASCOUT Geiger counter (P-1002722) be used (not included).
P-1006804

Contents:

- | | |
|---|--------------------------------------|
| 1 Base plate 340x250 mm | 2 Aluminium plates, 0.5 mm |
| 3 Work templates | 1 Aluminium plate, 1 mm |
| 1 Holder for sources and deflecting magnet | 1 Lead plate, 2 mm, in plastic cover |
| 1 Deflecting magnet | |
| 1 Thorium irradiation module (weld filler wire) | |



➤ Please ask for quantity discounts on class sets for 8 pieces and more

Includes 10 Experiments on the Subject of Radioactivity:

- Determining background radiation
- Determining pulse rates for various radioactive preparations
- Statistical distribution of counter pulses
- Determination of equivalent dose for various radioactive preparations
- Penetrative capacity and range of radiation
- Deflection of alpha and beta radiation by a magnetic field*
- Absorption of alpha rays*
- Absorption of beta rays*
- Absorption of gamma rays*
- Inverse square law

Equipment Radioactivity:

P-1006804 SEK Radioactivity

P-1002722 Geiger Counter GAMMASCOUT

*additionally required:

P-1006797 Radiation Cartiridge ^{226}Ra 4 kBq



Deflection of alpha and beta radiation by a magnetic field

Geiger Counter

Versatile, easy to use and compact precision instrument for measuring α -, β - and γ -radiation. With filter selection switch at the front of the Geiger-Müller counter tube for filtering out types of radiation (γ/β , $\gamma/\alpha/\beta$ or γ only), large display and integrated USB interface. Including USB cable, Windows software, and operating instructions. The following functions and operating modes are available for measurement:

- Standard mode for displaying the current radiation level. Display of the equivalent dose as a numerical value and a bar chart and display of the time until a selected cumulative dose limit is reached (default 5 $\mu\text{Sv/h}$). Also equipped with variable acoustic and optical warning threshold signal and display of average radiation from previous day.
- Pulse counting either permanent or with variable gate time. Gate time adjustable in seconds, minute or hours. Additional optional acoustic count indication.
- Count rate measurement. The pulses registered are measured successively and converted into a count rate (number of pulses per second).
- Integrated display of date and time for correct recording of measured radiation.
- The number of pulses registered is stored in the internal memory. This facilitates recording e.g. of weekly values for up to 10 years.
- Computer docking station. The software enables the measured data to be evaluated and processed on an MS-Windows PC.

Radiation types: α from 4 MeV, β from 0.2 MeV, γ from 0.02 MeV
 Measured variables: equivalent dose in Sv/h, mSv/h, $\mu\text{Sv/h}$
 pulses/s, pulses/variable time interval

Display: LCD, 4 digit, numerical with display of measured variable, quasi analogue bar chart, operating mode indicators

Radiation detector: End window Geiger-Müller counter tube, stainless steel housing with neon-halogen filling

Measuring length: 38.1 mm

Measuring diameter: 9.1 mm

Mica window: 1.5 – 2 mg/cm²

Gamma sensitivity: 114 pulses/min for ⁶⁰Co radiation = 1 $\mu\text{Sv/h}$
 in background radiation energy band
 approx. 10 pulses per minute

Background rate: approx. 10 pulses per minute

Internal memory: 2 kilobytes

Battery life: approx. 3 years

Dimensions: approx. 163x72x30 mm³

Weight: approx. 155 g

P-1002722



Absorption of beta radiation from the thorium cartridge

CD-ROM
 containing all
 different sets of
 instructions is
 included!

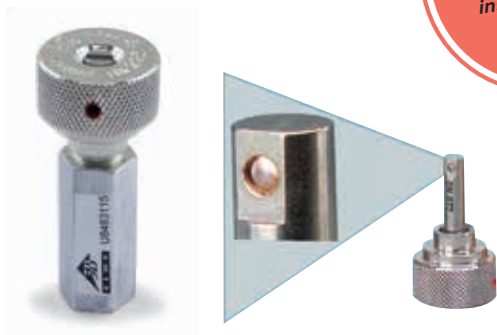

Radiation Cartridge, ²²⁶Ra, 4 kBq

Regulation-exempt radiation source with brass container for shielding. Radium sulphate rolled in gold foil and sealed at one end of a stainless steel cartridge.

Activity: approx. 4 kBq

Tolerance: -10% / +40%

Weight: approx. 400 g

P-1006797

Note:

In Germany, the ²²⁶Ra radiation cartridge is authorised for unlimited use. Its activity is approximately 4 kBq although it can be up to 40% higher or up to 10% lower. The limit for unlimited use of ²²⁶Ra is 10 kBq. Due to the special delivery conditions applying to radiation cartridges, transport costs are higher than usual.

SEK Solar Energy

Large equipment set for carrying out 16 fundamental experiments on solar energy. The basic parameters and properties of solar modules and the aspects which affect their energy efficiency can all be demonstrated by experiment. Contained in a rugged metal case including foam inlay with recesses in the shape of the apparatus. The system allows you to assemble experiments easily and in a compact set-up on or in the lid of the kit's carry case. Includes CD with experiment instructions.

SEK Solar Energy (230 V, 50/60 Hz)
P-1017732

SEK Solar Energy (115 V, 50/60 Hz)
P-1017731

Contents:

- | | |
|--|-------------------------------------|
| 1 Halogen spotlight | 1 Jumper |
| 2 Solar modules | 1 Set of experiment leads |
| 2 Digital multimeters | 1 Cross piece |
| 1 Lux meter | 1 Support brace |
| 1 Digital thermometer | 1 Set of items for covering modules |
| 1 Terminal board with resistor cascade | 1 Case |
| 1 Power adjuster | |



Includes instruction for 16 Experiments on Solar Energy:

- Illuminance of various light sources
- Parameters affecting the power generated by a solar module
- Shading of solar modules connected in series
- Effect of shading on the terminal voltage of a solar module
- Effect of illuminance on the open-circuit voltage and short-circuit current for a solar module
- Effect of angle of incidence on the open-circuit voltage and short-circuit current for a solar module
- Open-circuit voltage and short-circuit current for solar modules connected in series and in parallel
- Current-voltage characteristic for a solar module
- Current-voltage characteristic for solar modules in series
- Current-voltage characteristic for solar modules in parallel
- Optimum load resistance when the angle of incidence changes
- How the open-circuit voltage and short-circuit current for a solar module depend on temperature
- How power output from solar modules depends on temperature
- Voltage-current characteristic for illuminated and non-illuminated solar modules *
- Setting up a stand-alone power supply network **
- Energy conversion ***

Equipment Solar Energy:

P-1017732 SEK Solar Energy (230 V, 50/60 Hz)

or

P-1017731 SEK Solar Energy (115 V, 50/60 Hz)

P-1003312 DC Power Supply 0-20 V (230 V, 50/60 Hz)

or

P-1003311 DC Power Supply 0-20 V (115 V, 50/60 Hz)

(for experiments marked *)

P-1017734 Coulombmeter with Rechargeable Battery

P-1002811 Digital Stopwatch

(for experiments marked **)

P-1017735 Geared Motor with Pulley

P-1018597 Set of Weights 1 g to 500 g, slotted with Holder

P-1007112 Experiment Cord

P-1002811 Digital Stopwatch

(for experiments marked ***)

Coulombmeter with Rechargeable Battery

Coulombmeter for measuring the flow of current when storing energy in a rechargeable battery. Charge or consumption can be displayed by means of a voltmeter. Depending on the measuring range selected, 1 V in the voltmeter corresponds to either 0.1, 1 or 10 ampere seconds (As).

- Measuring ranges: 1/10/100 As (max. measurable charge ± 499 As)
- Power supply: 9 V rechargeable battery via DC co-axial power socket
- Load current: max. 500 mA
- Charging current for battery: max. 50 mA
- External power source: Solar panel or DC power supply (max. 12 V DC) with current limiting to 50 mA when there is no load on the coulombmeter
- Connectors: 4-mm safety sockets
- Dimensions: approx. 105x75x45 mm³
- Weight: 200 g including rechargeable battery and housing

P-1017734



Geared Motor with Pulley

The geared motor with string pulley is used in conjunction with the Solar Energy Student Experiment Kit as a load for demonstrating conversion of energy. The motor is mounted on a base plate and has a pulley attached for a string. Power is supplied via 4-mm safety sockets. Weights of up to approximately 1 kg can be lifted.

- Power supply: max. 12 V DC
- Load current: max. 50 mA
- Torque: 0.41 Nm
- Speed: 76.1 rpm with no load
- Connectors: 4-mm safety sockets
- Dimensions: approx. 105x75x45 mm³
- Weight: approx. 220 g

P-1017735

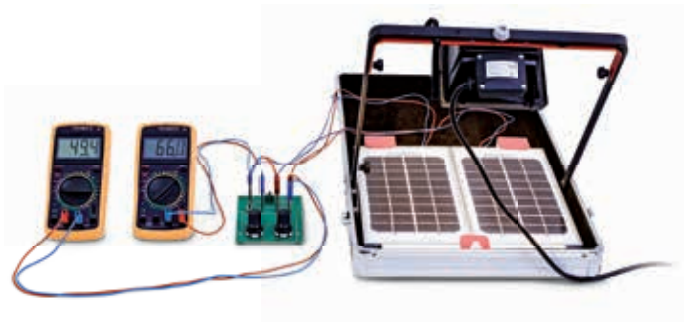

Optimum load resistance when the angle of incidence changes

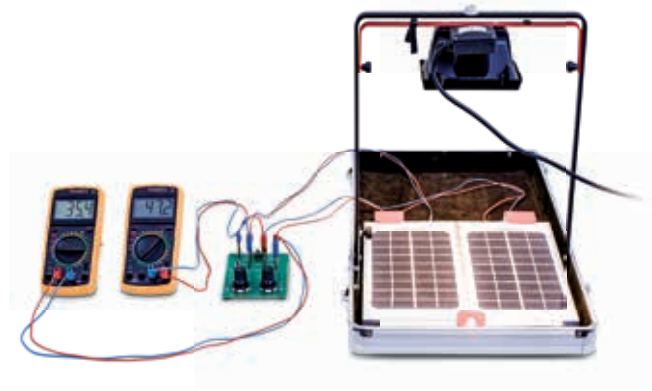

Current-voltage characteristic for solar modules in series

➤ Please ask for quantity discounts on class sets for 8 pieces and more



How power output from solar modules depends on temperature

Kröncke Optical System for Student Exercises

The Kröncke optical system provides robust reliability that has been tried and tested for decades and offers all the precision needed for student exercises and practical courses in numerous experiments on ray and wave optics. The experiments are carried out in traditional fashion using the white light of an incandescent lamp, the filament of which can be projected through an adjustable slit to observe interference in particular. All optical components are mounted in diaphragms with no stems and can easily be adjusted vertically and with precision into the optical light path when mounted on optical riders. Optical riders can freely move on the U-profile rail of an optical bench and can be attached with a minimum of force.

Basic Set for Kröncke Optical System

Contents:

- 1 Optical lamp
- 1 Transformer 12 V, 25 VA
- 1 Optical bench, 1000 mm
- 6 Optical slides
- 2 Clamps
- 2 Converging lenses, $f = 50$ mm
- 2 Converging lenses, $f = 100$ mm
- 2 Converging lenses, $f = 150$ mm
- 1 Converging lens, $f = 300$ mm
- 1 Converging lens, $f = 500$ mm
- 1 Diverging lens, $f = -100$ mm
- 1 Diverging lens, $f = -500$ mm
- 1 Diaphragm with 1 slit
- 1 Diaphragm with 3 slits
- 1 Photograph in slide frame
- 1 Transparent screen
- 1 White screen
- 1 Set of 4 colour filters
- 1 Ruler, 15 mm
- 1 Set of holes arranged to form the number "1"
- 1 Pinhole aperture, $d = 1$ mm
- 1 Pinhole aperture, $d = 6$ mm

➤ Please ask for quantity discounts on class sets for 8 pieces and more



Basic Set for Kröncke Optical System (230 V, 50/60 Hz)
P-1009932

Basic Set for Kröncke Optical System (115 V, 50/60 Hz)
P-1009931

Includes 12 Experiments on the Subject of Ray Optics:

- Pinhole camera
- Imaging with converging lenses
- Image aberrations
- Images in the eye (eye model)
- Correction of vision
- Magnifying glasses
- Microscopes
- Astronomical telescopes
- Terrestrial telescopes
- Slide projectors

Equipment Ray Optics:

P-1009932 Basic Set for Kröncke Optical System
(230 V, 50/60 Hz)

or

P-1009931 Basic Set for Kröncke Optical System
(115 V, 50/60 Hz)

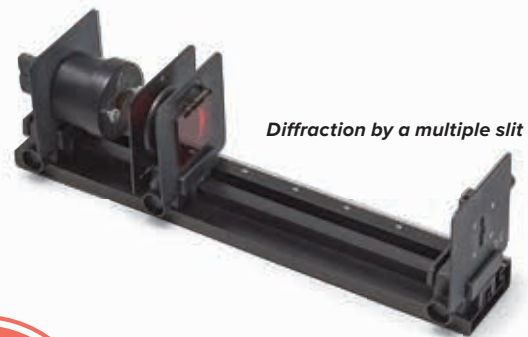

Diffraction by a multiple slit

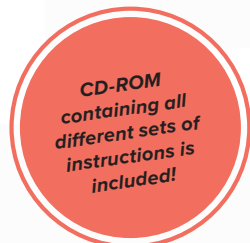

CD-ROM
containing all
different sets of
instructions is
included!



Slide projector

2m



Visibility of polarised light in turbid water

Includes 3 Experiments on the Subject of Polarisation:

- Polarisation of transverse waves
- Polariser and analyser
- Visibility of polarised light in turbid water
- Double refraction
- Rotation of planes of polarisation by a sugar solution

Equipment Polarisation:

P-1009932 Basic Set for Kröncke Optical System (230 V, 50/60 Hz)

or

P-1009931 Basic Set for Kröncke Optical System (115 V, 50/60 Hz)

P-1009701 Supplementary Set for Polarisation



Supplementary Set for Polarisation

Supplementary set to the Kröncke optics basic set (P-1009932 or P-1009931) for carrying out student experiments on the polarisation of light waves.

Contents:

- 1 Pair of polarising filters
- 1 Pinhole aperture, 10 mm
- 1 Rectangular cuvette

P-1009701



Supplementary Set for Interference

Supplementary set to the Kröncke optics basic set (P-1009932 or P-1009931) for carrying out student experiments on the interference of light waves.

Contents:

- 1 Optical bench, 500 mm
- 1 Adjustable slit
- 1 Diaphragm with 9 circular discs
- 1 Diaphragm with 9 circular holes
- 1 Diaphragm with 3 individual slits and 1 double slit
- 1 Diaphragm with 4 multiple slits and grating
- 1 Diaphragm with 3 ruled gratings
- 1 Micrometer screw
- 1 Fresnel mirror

P-1009700

Includes 10 Experiments on the Subject of Interferences:

- Fresnel mirror
- Diffraction by small openings and plates
- Diffraction by an air gap
- Diffraction by the wire
- Diffraction by multiple slits
- Diffraction by the grating
- Optical resolution
- Determining the wavelength of light

Equipment Interference:

P-1009932 Basic Set for Kröncke Optical System (230 V, 50/60 Hz)

or

P-1009931 Basic Set for Kröncke Optical System (115 V, 50/60 Hz)

P-1009700 Supplementary Set for Interference

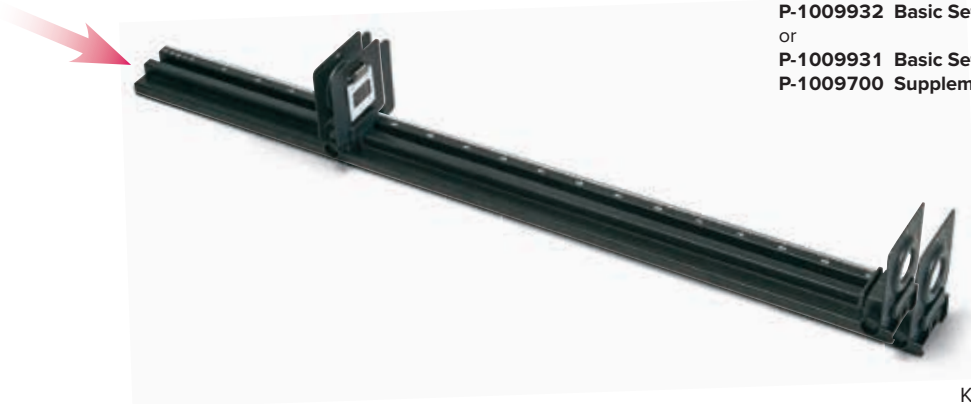

Experiment Topics:

- Displacement-time graphs
- Linear gradients
- Velocity

Constant Velocity STUDENT Kit, 3 Tubes

Set of equipment for investigating the concept of velocity by means of student experiments. Consisting of three small coloured plastic tubes in which an air bubble rises at constant velocity in a viscous liquid, provided the tubes are aligned vertically. Since the viscosities differ, the velocities also differ. The position of the air bubble is plotted against time. The three different resulting straight lines lead to a definition of velocity.

Length: approx. 500 mm

Diameter: approx. 13 mm

P-1003502

Additionally required:

P-1003369 Mechanical Stop Watch, 15 min

P-1002603 Pocket Measuring Tape, 2 m

Displacement-time graph for air bubbles and the balls

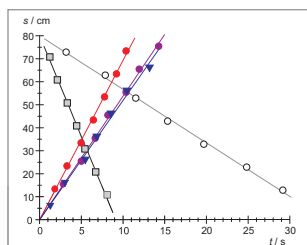

Displacement-time graph for air bubbles

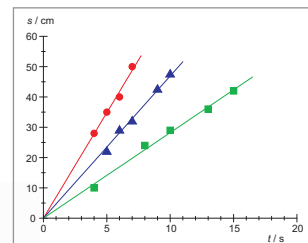

Advantage

- It is possible to demonstrate both positive and negative velocities

Constant Velocity STUDENT Kit, 4 Tubes

Set of equipment for investigating the concept of velocity by means of student experiments. It consists of one transparent and three coloured plastic tubes. In the coloured tubes an air bubble rises with constant speed in a viscous fluid as soon as the tube is held vertical. Since the viscosities inside the tubes differ, the velocities with which the bubbles rise in each of them are also different. The transparent tube also contains a plastic ball and a metal ball which sink down the tube thus demonstrating negative velocities. The positions of the bubble or the balls are plotted on a graph. The gradients of the various resulting straight lines lead to a definition of velocity.

Length: approx. 830 mm

Diameter: approx. 13 mm

P-1018624

Additionally required:

P-1003369 Mechanical Stop Watch, 15 min

P-1002603 Pocket Measuring Tape, 2 m

Experiment Topics:

- Determining mass of evacuated air and density of air
- Effect of air pressure on a slightly inflated hot-air balloon and on a suction cap
- Lowering of the boiling point of liquids at decreased air pressure

Vacuum STUDENT Kit

Set of equipment for introducing the fundamentals of vacuum physics by means of student experiments.

Contents:

- 1 Experiment plate with washer
 - 1 Vacuum bell jar
 - 1 Beaker
 - 1 Pressure hose with check valve
 - 1 Pressure hose with T-connector and check valve
 - 1 Simple hand pump in storage container
 - 1 Suction cap
 - 2 Balloons
- P-1003494**

Additionally recommended:

P-1020859 Electronic Scale Scout SKX 420 g

Effect of air pressure on a slightly inflated balloon



Experiment Topics:

Colours:

- Coloured light and coloured objects
- Mixture of colours

Shadows:

- Casting shadows
- Coloured shadows

Reflection:

- Reflection from a plane mirror
- Reflected images, image reversal
- Multiple reflections from a mirror
- Reflection from a concave mirror (focal point and spherical aberration)
- Reflection from a parabolic mirror
- Reflection from a convex mirror

Refraction:

- Determining refractive index with a semi-circular object
- Determining refractive index with a parallel block
- Angle of minimum deflection for a prism
- Total internal reflection in a semi-circular object
- Total internal reflection in a prism
- Focal point of a converging lens
- Focal point of a diverging lens
- Spherical aberration



Light Box P

Set of equipment for optical experiments to be carried out on a table, consisting of a light box in a sturdy plastic housing and numerous optical components. Complete set in sturdy styrofoam storage case. The light box has four light outlets: the two side outlets have two hinged mirrors for experiments on colour mixing and shadows. All openings are equipped with mounts for optical components in 50x50 mm² slide frames. Parallel, convergent and divergent light can be generated by adjusting a converging lens attached in front of the lamp. There are two double-sided slit diaphragms available so that four different beam configurations can be created.

Lamp: 12 V, 36 W
Connections: 4-mm socket
Light box: approx. 175x100x65 mm³
Storage case: approx. 250x240x100 mm³

P-1018471

Additionally required:

P-1020595 Transformer 12 V, 60 VA (230 V, 50/60 Hz)

or

P-1006780 Transformer 12 V, 60 VA (115 V, 50/60 Hz)

Contents:

- 1 Light box
- 8 Colour charts
- 1 Plane mirror (glass)
- 1 Concave mirror (metal)
- 1 Convex mirror (metal)
- 1 Bi-convex lens, large (transparent acrylic)
- 1 Bi-convex lens, small (transparent acrylic)
- 1 Bi-concave lens (transparent acrylic)
- 1 Parallel plate (transparent acrylic)
- 1 Semi-circular object (transparent acrylic)
- 1 160° prism (transparent acrylic)
- 1 Asymmetrical 90° prism (transparent acrylic)
- 1 Symmetrical 90° prism (transparent acrylic)
- 2 Slit diaphragms
- 8 Colour filters (in slide frame)
- 1 Pair of connector leads with 4-mm plugs
- 1 Spare lamp

Spare Lamp for Light Box (not shown)

Spare lamp for light box, 12 V, 36 W.

P-1003231

Physical Eye Model

This physical eye model can be used to demonstrate the optical functions of the human eye, e.g. representation of an object on the retina, accommodation (change in the lens curvature), short-sightedness and far-sightedness.

The physical eye model comprises:

- Half eyeball with adjustable iris diaphragm, lens holder and 2 convex lenses ($f = 65$ mm and 80 mm), on a rod
- Half eyeball with retina (transparent screen), on a rod
- Lens holder with one concave and one convex corrective lens, on a rod
- Candle holder with 2 candles, on a rod
- Aluminium rail, 50 cm long, with 4 clamp slides
- Storage case for physical eye model

Dimensions: approx. 490x55x180 mm³

Weight: approx. 2 kg

P-1003806

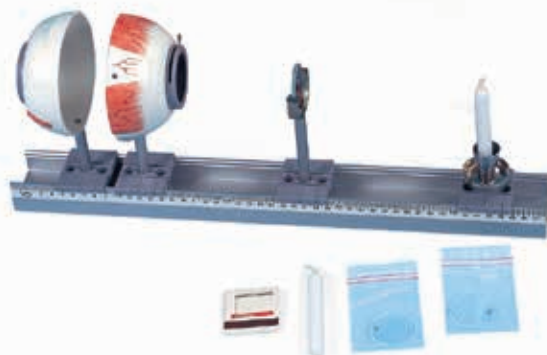



Fuel Cell Demonstration System

Model showing the function of a hydrogen solar cell consisting of solar module, PEM electrolyser, hydrogen and oxygen accumulators, PEM fuel cell and fan. Conveniently arranged on a baseplate.

Solar module: 2.0 V / 350 mA
 Electrolyser: 1 W
 Fan output: 10 mW
 Dimensions: approx. 100x300x150 mm³
 Weight: approx. 600 g

P- 1002689

The fuel cell demonstration system and the accessories allow students to gradually investigate the world of fuel cells and solar-hydrogen technology in many illustrative and quantitative experiments.

Experiment Topics:

- Current-voltage curve of a solar cell.
- Power curve and efficiency of a solar cell.
- Current-voltage curve of a PEM electrolyser
- Energy efficiency and Faraday efficiency of a PEM electrolyser
- Current-voltage curve of a PEM fuel cell
- Power curve of a PEM fuel cell



Fuel Cell Accessories

Kit for conducting student experiments with the fuel cell demonstration system. With a decade resistor specially designed for recording the individual components' characteristics.

P- 1021790

Contents:

- 1 Decade resistor with a maximum load capacity of 1 W
- 2 Multimeters
- 2 Multimeter batteries (9V)
- 4 Connection cables, 2 mm, 50 cm, red
- 4 Connection cables, 2 mm, 50 cm, black
- 1 Stopwatch

Decade resistor:

Max. load capacity: 1.2 W
 Jacks: 2 mm
 Dimensions: approx. 40x160x130 mm³
 Weight: approx. 190 g

Multimeter:

Jacks: 2 mm
 Dimensions: approx. 125x70x30 mm³
 Weight: approx. 140 g

For your safety:

Exclusive use of distilled water.
 No corrosive electrolytes such as potassium hydroxide (KOH).

COMPUTER-ASSISTED EXPERIMENTATION

The most versatile and complete software for STEM Education. Coach your students into the world of science.

Coach

Coach is a Learning and Authoring Environment for Science, Mathematics and Technology Education. It is a product of CMA based on over 25 years of research and development. Continuous feedback from users, (students, teachers, curriculum developers) and from educational research has enabled us to create a unique environment used by many, teachers and students, worldwide. Coach integrates ICT tools, which resemble technologies used by professional scientists and facilitates an inquiry-based approach to education.

- With Coach 7 you have the most complete environment for STEM Education!
- Suitable for many platforms
- Can be used by teachers and students, in school and at home
- All needed tools in one environment
- Easy but also comprehensive, offering advanced options when needed
- Intuitive handling of sensors
- Pre-calibrated sensors but when desired own calibration can be done
- Allows to store a new sensor calibration in the sensor's memory
- The only environment which offers dynamical modeling
- Video measurement with automatic tracking and perspective correction
- Easy to learn via many simple, placed in context, step-by-step tutorials
- Free access to a large data-base with innovative teaching resources

Coach 7 Licenses

- 5 Years Site License
- Yearly Fee Site License
- Single User License

Coach 7 Lite

If you think you do not need all the power of Coach 7 or you work with primary level students Coach 7 Lite is available at no charge for use with the interfaces VinciLab and €Lab. Register and download at the website: www.cma-science.nl

Coach 7, Single User License 5 Years
P-1021518

Coach 7, Site License 5 Years
P-1021522

Coach 7, University License 5 Years
P-1021524

You can find further licenses on our website: 3bscientific.com

Always and anywhere

Education is changing: tablets and laptops have become essential for students and teachers. With Coach 7 you are ready for the education of the 21st century and for a Bring Your Own Device (BYOD) policy at your school. You can use Coach 7 on your computer, laptop or tablet, at home or at school.

Suitable for:

Android tablet, iPad, Windows tablet, PC computer, MAC computer



The most versatile and complete software for STEM Education. Coach your students into the world of science.

Data-logging

An interface equipped with a selection of sensors is a universal measurement instrument and can be used in many experiments. The Coach Measurement Activities enable you to measure and record data over a period of time via an interface and sensors. The rate of data collection is available over a wide range of time-periods and frequencies. Different measurement methods: time-based (with- and without triggering), event-based, manual (with- and without sensors) allow performing a wide range of experiments. Real-time presenting data while being collected makes data collection an interactive process whereby direct observations may be immediately compared with the graph, encouraging thinking about the data.

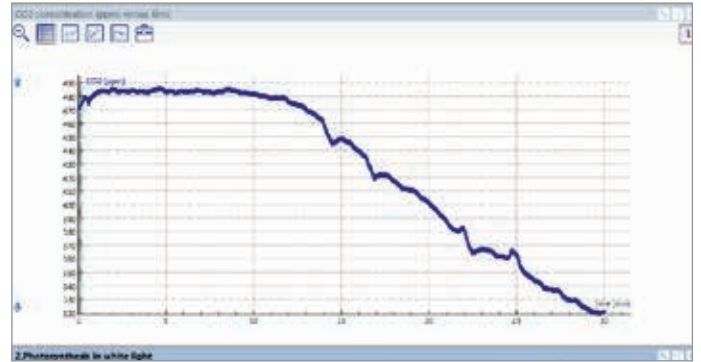

Data Video

Brings the real world into your classroom and allows analyzing attractive events and “difficult” experiments that are impossible to perform in the classroom. The Coach Data Video Activities enable you to make measurements on digital video clips (manually by clicking or automatically by tracking the selected object) or still images, and to analyze motions or shapes of real objects. To bridge the gap between the visual display of a motion and its abstract graphical representation the graphs are synchronized with the video frames. Students can capture their own videos with the help of a camera or mobile phone. They also can use affordable high-speed cameras to capture very fast motions and to analyze these motions in details. Additionally Coach offers many extra features like capturing and editing a video or correcting a perspective distortion.

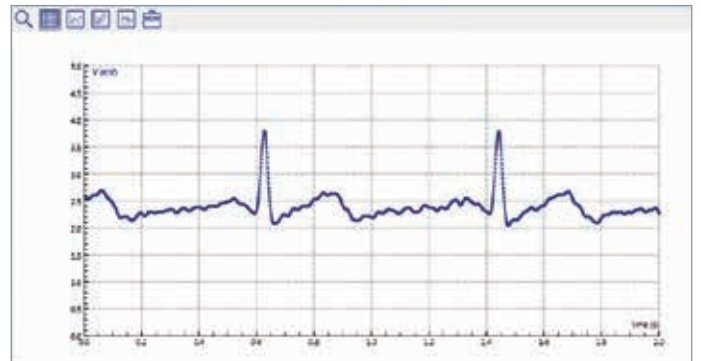

Modeling

Helps students to understand the world of computational models; such models are used today in every area of research and industry. The Coach Modeling Activities enable you to use ready-to-go models or to create models of dynamic changing systems. In such models the evolution of a system is computed step by step. Modeling allows solving realistic problems that are difficult to solve analytically at the school level. It encourages students to think, to discuss their ideas and to clarify their understandings. The data generated by a model can be compared with experimental data and the model can be modified to match the real experiment.

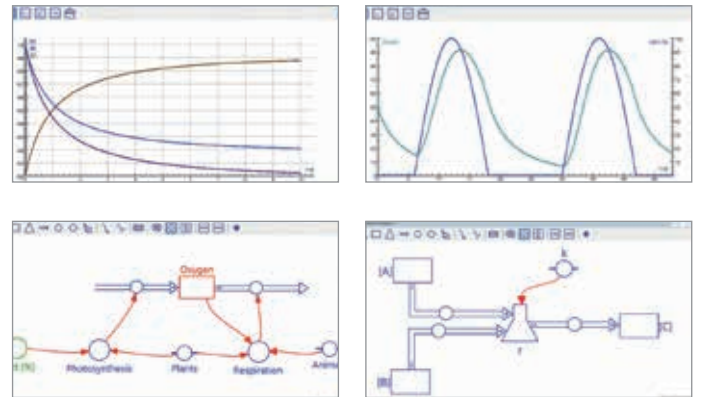

Data Processing

Data collected from sensors, video clips or generated by models can be displayed as digital values, on meters and graphs. They can be further processed with the help of:

- Analysis tools: zooming, reading values, finding a slope, finding an area under a graph,
- Processing tools: selecting and removing data, smoothing a graph, calculating new variables by using mathematical functions, function fit, calculating a frequency spectrum
- Statistical tools: finding statistical data information, creating a histogram.

Animations

Help students to better understand the meaning of data. Presenting data in a table or graph may not be enough for students to fully understand the underlying principles of a phenomenon. Animation is another way of representing the data. The Coach Animations consist of animated graphics objects, like ellipses, rectangles, vectors or images, which can be linked to model variables, program variables or sensor values to control their screen movement. Additionally interactive control objects, like buttons and sliders, allow altering parameter variables during the execution of the animation to interact with the system and to see the effect of those changes.

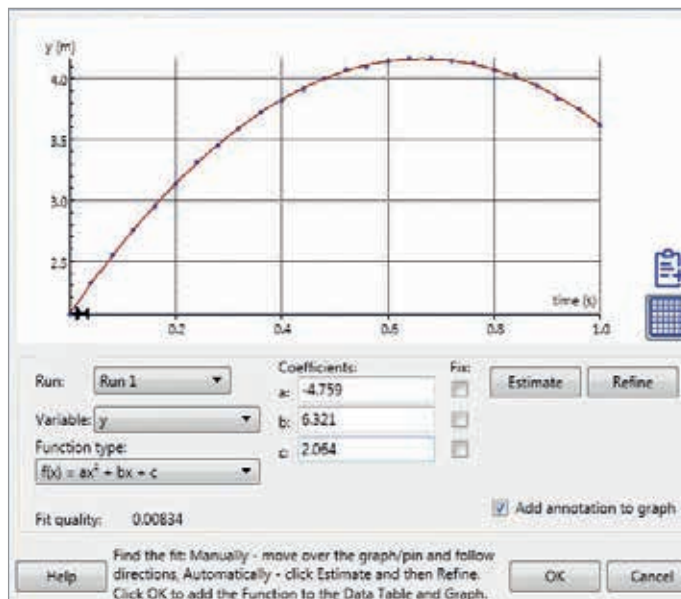

Authoring facilities

Build your own activities CMA offers many ready-to-go teaching and learning activities. You can use these activities directly in the lessons or adapt them to your own needs. Coach also enables you to build your own activities filled with exciting learning content. Create your own custom activities with the type of tool to be used, for the desired student level, with your texts, images, videos, student questions, and with a layout that displays the way you want it.

Control

The unique combination of measuring and control allows controlling processes, to automate measurements and to study the behaviour of systems.

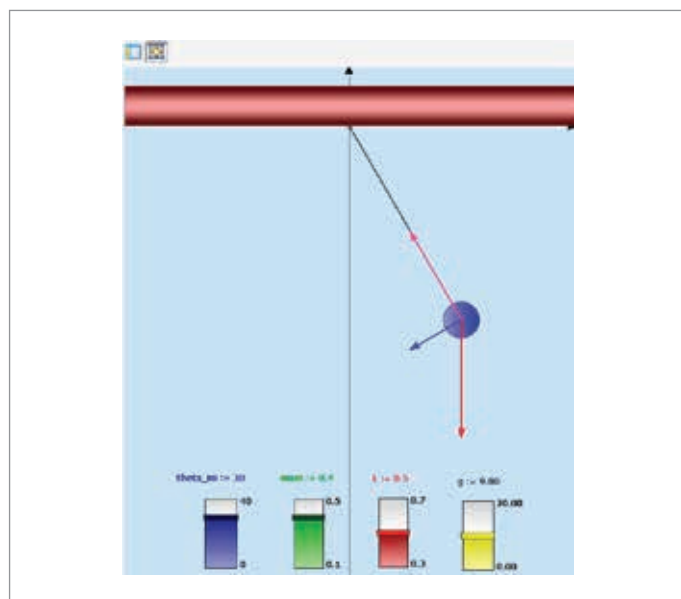

VinciLab – the most powerful and versatile data-logger

VinciLab

The VinciLab is a modern advanced graphic data-logger. It is a handheld Linux device equipped with two processors and 8 GB memory. Works standalone and with Windows and MAC computers. The dedicated desktop applications, installed on VinciLab, offer tools for collecting data, managing user files, setting up the device and its wireless connection, browsing the web, watching video files, playing audio files, etc. All applications can be easily updated via the VinciLab Update server available via a Wi-Fi connection. The powerful Coach Application, installed on VinciLab, offers live sensor data displays, real-time graphing, tools for data processing and possibilities to create new or open ready-to-go student activities (experiment manuals), enriched with texts, images and weP-pages. Coach 7 and Coach 7 Lite support measurements with VinciLab. During such measurement VinciLab is connected to the computer via a USB port or communicates via a Wi-Fi connection, and is controlled by Coach running on the computer. The collected data are transferred in real-time to the computer and the measurement can be followed directly on the computer screen. By using wireless connectivity and the VNC protocol the VinciLab's screen can be remotely viewed and controlled from any computer or mobile device connected to the same network.

Display:	5" high-resolution capacitive color touch screen
Resolution:	12-bit
Sampling rate:	1 MHz
Sensor inputs:	Four analog BT inputs, two digital BT inputs
Built-in:	Sound sensor, 3-axis, accelerometer (2 g, 4 g, 8 g)
Wireless connectivity:	Wi-Fi and Bluetooth®
Computer connection:	USB mini port
USB port:	Full USB for USB peripherals
Software on board:	Coach Linux
Software on computer:	Coach 7or Coach 7 Lite
Power supply:	Rechargeable battery, via USB from computer or via power adapter

P-1021477



Four analog and two digital inputs

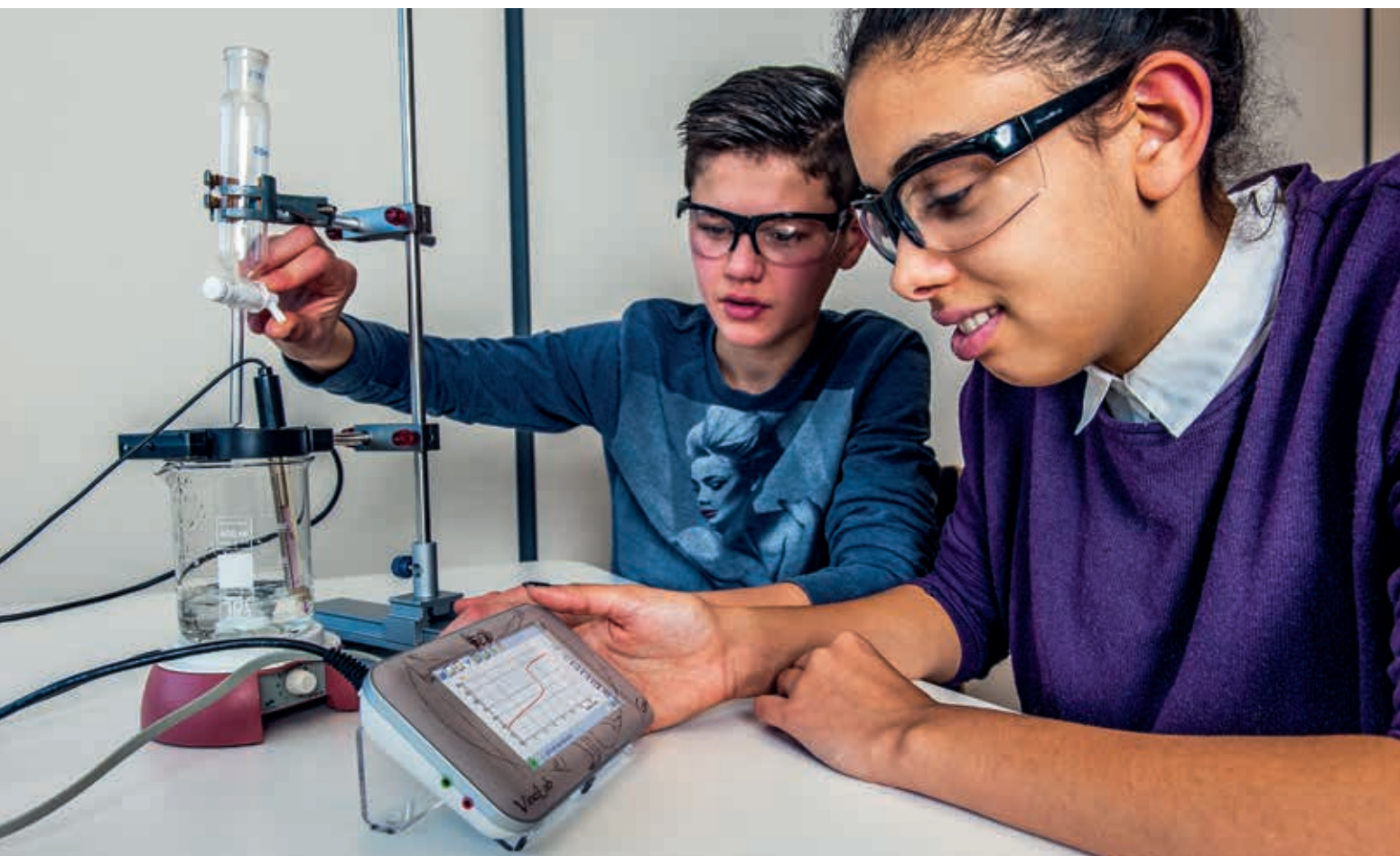



Motion Detector €Motion

€Motion is an ultrasonic motion detector that connects directly to a computer through a USB-port. The €Motion measures the distance between the sensor and an object. €Motion can work in combination with the €Lab interface.

Range: 0.20 m ... 6 to 10 m (depending on an object's shape, size and surface)

Computer connection: USB

Power supply: via USB

Includes: a steel rod.

Can be used to:

- record motions during walking toward and away from the sensor,
- investigate simple harmonic motion,
- record motions of objects dropped or tossed upward.

P-1021673



€Lab

€Lab is a simple and friendly USB lab interface, which can be used to introduce students to measurements with the computer. This is a good solution for users who don't need the versatility of a standalone device.

Resolution: 12-bits

Sampling rate: 40 kHz

Sensor Inputs: two analog BT inputs

Computer connection: USB

Software on computer: Coach 7 or Coach 7 Lite

Power supply: via USB, no extra power supply needed

P-1021478

Comparison of the interfaces

Interface	€Lab	VinciLab
School level	middle	middle/high
Sampling rate	40 kHz	1 MHz
Sensor inputs	2 analog	4 analog, 2 digital
Power supply	via USB	rechargeable battery
Screen	no	Touch screen 5"
Operating system	internal	Linux
Device software	none	Coach App
Platforms	PC, Mac	PC, Mac, Stand alone
Connection	USB	USB
Computer software	Coach 7, Coach 7 Lite	Coach 7, Coach 7 Lite



Motion Detector *

The Motion Detector 0664 uses ultrasound to measure the distance between the sensor and an object. This Motion Detector has a digital BT connector and can be connected to digital inputs of the VinciLab interface.
 Range: 0.2 .. 6 to 12 m (depending on an object's shape, size and surface)
 Frequency of ultrasound: 50 kHz
 Typical accuracy: ± 1 mm
 Includes: a steel rod.

- Can be used to:
- record motions during walking towards and away from the sensor,
 - investigate simple harmonic motion.
 - record motions of objects dropped or tossed upward.

P-1021683



Light Barrier

The light barrier is used for timing and pulse counting in conjunction with VinciLab (1021477) or the digital counter (P-1001033/P-1001032). Two operating modes are available:
 1. Internal light barrier mode: Light barrier with infrared light source and IR detector with very short signal delay.
 2. Laser light barrier mode: Laterally installed laser detector diode for setting up a long-range barrier in conjunction with a laser pointer, for example, at sporting events.

Fork aperture: 82 mm
 Dimensions (without stand rod): approx. 120x80x22 mm³
 Included in the scope of delivery: On threaded stand rod, one M6 screw, one M6 knurled nut, one retaining plate and a connection cable with 8-pin mini-DIN plugs.

- Can be used to:
- determine the instantaneous speed of moving bodies
 - determine the gravitational acceleration g
 - measure the periods of oscillating bodies

P-1000563

Additionally required:

P-1021688 Connection Cable MiniDIN8 – BT



Displacement Sensor FW

Displacement sensor FW is used to record periodic / oscillating movements which can be registered via a cord on the cord roller.

The sensor has a rotating cord roller and a built-in precision potentiometer.
 Wheel: 24 mm Ø
 Maximum displacement: approx. 66 mm
 Displacement resolution: approx. 1/6 mm
 Included in the scope of delivery: One threaded stand rod.

- Can be used to:
- record the pV diagram of a Stirling engine G
- P-1021534**

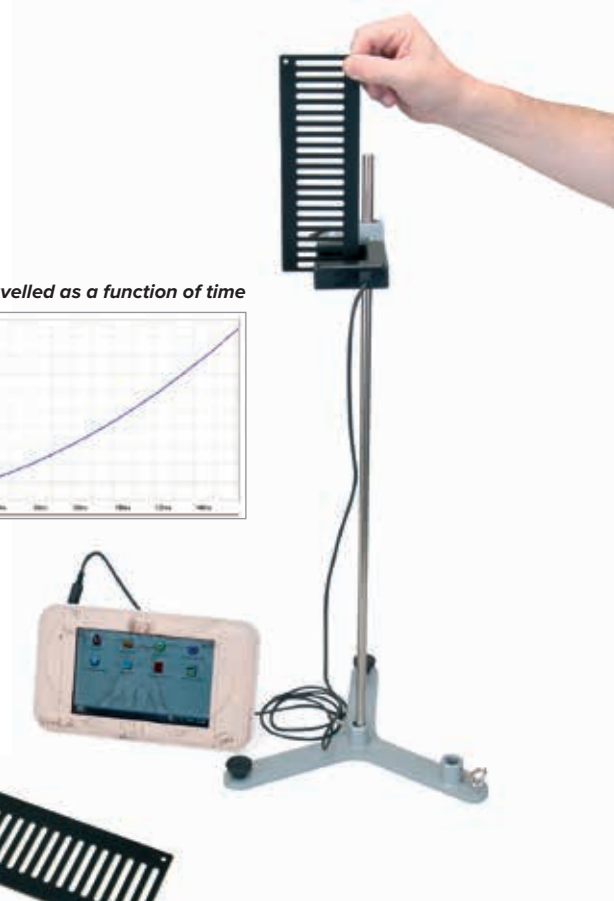

Distance travelled as a function of time

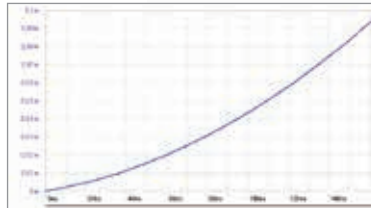

Picket Fence

The picket fence is used to determine gravitational acceleration g in conjunction with the light barrier (P-1000563). It consists of anodized aluminium sheets with 21 crosspieces and two boreholes for suspending additional masses.

Crosspiece interval: 10 mm
 Dimensions: approx. 205x75 mm²

- Can be used to:
- determine the gravitational acceleration g
- P-1000564**



Accelerometer 5 x g

The Low-g Accelerometer BT10i can be used to study accelerations in one-dimensional motions. The sensing element of the sensor is located inside the small round box, which can be mounted on a moving object. This is the best choice for most experiments.

Range: -5 g ... 5 g

Accuracy: 0.05 g

Can be used to:

- measure acceleration of a moving car, in elevators, on playground apparatus, during amusement park rides,
- determine the tilt of an object,
- investigate accelerations during body movements.

P-1021674



Accelerometer 25 x g

The High-g Accelerometer BT11i can be used to study larger accelerations in onedimensional motions. The sensing element of the sensor is located inside the small round box, which can be mounted on a moving object.

Range: -25 g ... 25 g

Accuracy: 0.2 g

Can be used to:

- measure acceleration during collisions,
- investigate larger accelerations.

P-1021675



Force Sensor

The Force sensor BT42i measures pushing and pulling forces. It uses strain gauge technology. The sensor has two measurement ranges, which can be selected using a switch.

Range: -5 ... 5N, -50 ... 50 N.

Resolution (12-bit): 0.003 N, 0.03 N

Includes: a thumbscrew, a utility handle, a bumper and a hook.

Can be used to:

- replace a hand-held spring scale, can be
- mounted on a ring stand or on a dynamics cart to study collisions.
- measure of centripetal or frictional forces, study Newton's laws, investigate static and kinetic friction.

P-1021676



Force Plate *

The Force plate 0364 measures forces of stepping, jumping and other human-scale actions. The Force Plate has two ranges, one for larger forces, and a more sensitive range for pushing experiments.

Range: -800 ... 3500 N, -200 ... 800 N

Resolution (12-bit): 1.2 N, / 0.3 N

Includes: one pair of handles for pushing and pulling.

Can be used to:

- study dynamics of jumping and walking
- study how the normal force acting on human feet changes during elevator ride.

P-1021677

* Sensor Cable

All sensors not marked with * require a sensor cable, which has to be purchased separately. The cables are sold per piece (P-1021514) and in packages of four (P-1021515).



Current Sensor 5 A

The Current sensor BT21i is a general-purpose sensor to measure currents in the range between -5 and 5 A. It has two 4-mm plugs for easy connection. The sensing element is a 0.04Ω resistor connected between the red and black terminals.

Range: -5 ... +5 A
Resolution (12-bit): 3.8 mA

Can be used to:

- investigate relationships between voltage and current,
- verify Ohm's law,
- measure currents in series and parallel electrical circuits.

P-1021678



Charge Sensor

The Charge sensor BT19i measures electrostatic charges. It can replace a traditional electrostatic scope by showing not only the polarity of the charge but also performing quantitative measurements. The sensor has three operating ranges, which can be selected using a switch.

Range: -5 ... 5 nC, - 25 ... 25 nC, - 100 ... 100 C
Resolution (12-bits): 0.0025 nC, 0.013 nC, 0.05 nC

Can be used to:

- measure magnitude and sign of the charge on different objects,
- investigate electrostatic phenomena,
- charging by induction, friction and by contact.

P-1021684



Voltage Sensor 500 mV, Differential

The Voltage sensor BT32i is designed for measuring voltages between -500 and +500 mV. The sensor has differential inputs; measurements can be done directly across circuit elements without the constraints of common grounding. It has two 4-mm plugs for easy connection.

Range: -500 ... +500 mV
Resolution (12-bit): 338 μ V

Can be used to:

- measure small voltages in AC and DC circuits,
- record characteristics of a light bulb or a diode,
- measure voltages in series and parallel electrical circuits.

P-1021681



Voltage Sensor 10 V *

The Voltage sensor BT02 is a low-cost, generic sensor that measures voltage. This sensor has a direct connection to the inputs of a measurement interface. It has two 4-mm plugs for easy connection.

Range: -10 ... +10 V.
Resolution (12-bit): 4.9 mV

Can be used to:

- measure voltage during discharging of a capacitor
- investigate battery life
- record electromagnetic induction.

P-1021682



Current Sensor 500 mA *

The Current sensor 0222i can be used to measure currents in the range between -500 and 500 A. It has two 4-mm plugs for easy connection. The sensing element is a 0.4Ω resistor connected between the red and black terminals.

Range: -500 ... +500 mA
Resolution (12-bit): 0.38 mA

Can be used to:

- investigate relationships between voltage and current,
- verify Ohm's law,
- measure currents in series and parallel electrical circuits.

P-1021679



Voltage Sensor 10 V, Differential

The Voltage sensor 0210i is designed for measuring voltages between -10 and +10 V. The sensor has differential inputs; measurements can be done directly across circuit elements without the constraints of common grounding. It has two 4-mm plugs for easy connection.

Range: -10 ... +10V
Resolution (12-bit): 6.5 mV

Can be used to:

- measure voltages in AC and DC circuits,
- record characteristics of a light bulb or a diode,
- measure voltages in series and parallel electrical circuits.

P-1021680



High-Current Shunt

The high-current shunt is a sensor with a shunt resistor for measuring high electrical currents in DC and AC circuits.

Range: 0 – ±10 A
 Maximum current: ± 20 A for 15 s
 Accuracy: < 1%
 Sensor type: Shunt resistor 5 mΩ / 2 W

P-1000545

Additionally required:

P-1021681 Voltage Sensor, 500 mV, Differential

P-1021514 Sensor Cable



Magnetic Field Sensor

The Magnetic field sensor BT52i contains a Hall-element, which is sensitive to a magnetic field. It has two measurement ranges, which can be selected using a switch. The sensor is very suitable for measuring the magnetic field inside coils, or near (strong) permanent magnets.

Ranges: -10 ... +50 mT, -100 ... +500 mT
 Resolution (12-bit): 0.024 mT, 0.24 mT

Can be used to:

- measure the magnetic field near a (strong) permanent magnet,
- investigate the magnetic field near a current-carrying wire,
- measure the magnetic field near or inside a coil or solenoid.

P-1021685



Magnetic Field Sensor FW ± 200 mT

Magnetic field sensor FW ± 200 mT is used to measure magnetic flux density in the axial and tangential directions. Located on the tip of the probe is a Hall sensor with an output signal proportional to the operating voltage. The sensor is equipped with two range buttons and one tare button, as well as a visual display of the currently active measurement range.

Range: 0 – ±2 mT, 0 – ±20 mT, 0 – ±200 mT
 Resolution: 0,01 mT, 0,1 mT, 1 mT
 Sensor: 500 mm long

Can be used to:

- measure the magnetic fields of cylinder and Helmholtz coils

P-1021798



Magnetic Field Sensor FW ± 2000 mT

Magnetic field sensor FW ± 2000 mT is used to measure magnetic flux density in the tangential direction. Located on the tip of the probe is a Hall sensor with an output signal proportional to the operating voltage. The sensor is equipped with two range buttons and one tare button, as well as a visual display of the currently active measurement range.

Range: 0 – ±2 mT, 0 – ±20 mT, 0 – ±200 mT, 0 – ±2000 mT
 Resolution: 0,01 mT, 0,1 mT, 0,5 mT, 1 mT
 Sensor: 135 mm long

Can be used to:

- investigate the Hall effect in semiconductors and metals
- record hysteresis curves
- investigate the Biot-Savart law

P-1021766



Humidity Sensor

The humidity sensor BT72i measures relative humidity. The sensor consists of an integrated circuit, which uses a capacitive polymer to sense humidity. The holes in the sensor box provide air circulation.

Range: 0 ... 100 %

Resolution (12-bit): 0.04 % RH

Can be used to:

- study transpiration rates of plants,
- optimize conditions in a greenhouse or terrarium,
- determine good days for static electric demonstration.

P-1021510



Sound Sensor

The sound sensor BT80i consists of a microphone followed by an internal amplifier. It measures variations in air pressure caused by sound waves. Because of the high sensitivity, the sensor is very much suited to detect pressure pulses. The dB-calibration in the Coach software allows using this sensor for dB-measurements (up to 124 dB).

Range: -45 ... 45 Pa

Resolution (12-bit): 22 mPa

Can be used to:

- measure sound waveforms and beat patterns,
- investigate human voice and sounds from various musical instruments,
- measure the speed of sound through air and other materials.

P-1021513



Pressure Sensor

The pressure sensor BT66i is designed to measure absolute gas pressure. The pressure is measured via a pressure valve, which is located on the side of the box. The sensor has two measurement ranges, which can be selected using a switch.

Range: 0 ... 700 kPa, 0 ... 130 kPa

Resolution (12-bit): 0.2 kPa, 0.04 kPa

Includes: a plastic 20-ml syringe with Luerlock, two plastic tubes (5 cm and 45 cm long), a three-way valve with Luer-lock connectors, two Luer-lock connectors.

Can be used to:

- measure pressure changes in gas-law experiments, Boyle's and Gay-Lussac's laws,
- measure vapor pressure of liquids,
- measure air pressure for weather studies.

P-1021511



Temperature Sensor

The temperature sensor BT84i measures temperature and temperature differences in the range between -20°C to 110°C. This sensor uses the solid-state temperature transducer, whose output is linearly proportional to the temperature. The transducer is positioned in the point of a stainless steel tube. In liquids the response of the temperature sensor is quite fast (in between 1.3 and 2.0 s).

Range: -20°C ... 110°C

Resolution (12-bit): 0.07°C

Can be used to:

- monitor indoor and outdoor temperatures,
- monitor freezing and boiling water,
- investigate the temperature during endothermic and exothermic reactions,
- investigate evaporation.

P-1021499



Relative Pressure Sensor FW ± 100 hPa

The relative pressure sensor FW is used to measure relative pressures. The sensor is equipped with two measuring chambers via whose terminals pressure differences can be measured.

Range: 0 – ± 100 hPa

Accuracy: $\pm 1\%$

Hose shaft: 4 mm \varnothing

Included in the scope of delivery: Silicone hose, 1 m.

Can be used to:

- measure the hydrostatic pressure in a water column
- measure the pressure differences in a Stirling engine D

P-1021532



Relative Pressure Sensor FW ± 1000 hPa

The relative pressure sensor FW is used to measure relative pressures. The sensor is equipped with two measuring chambers via whose terminals pressure differences can be measured.

Range: 0 – ± 1000 hPa

Accuracy: $\pm 1\%$

Hose shaft: 4 mm \varnothing

Included in the scope of delivery: Silicone hose, 1 m.

Can be used to:

- measure the hydrostatic pressure in a water column
- measure the pressure differences in a Stirling engine G

P-1021533



Temperature Sensor NTC *

The temperature sensor BT01 is a low-cost, general-purpose temperature sensor that can be used to measure temperature in the range of -40°C to 140°C , in liquids (water, mild acidic solutions) and air. The sensing element of the sensor is an NTC thermistor, which is positioned in a stainless steel tube. The thermistor is a variable resistor whose resistance decreases nonlinearly with increasing temperature.

Range: -40°C ... 140°C

Accuracy: 2°C at -40°C ; 0.6°C at 30°C ; 1.8°C at 140°C

Can be used to:

- monitor indoor and outdoor temperatures,
- monitor freezing and boiling water,
- investigate the temperature during endothermic and exothermic reactions,
- investigate evaporation.

P-1021497

Thermocouple Type K *

The thermocouple sensor 0135i measures temperatures in two ranges, which can be selected using the switch. The sensor uses a thermocouple type K, which consists of Chromega and Alomega wires that are welded together to form a measuring junction.

Range: -200 ... 1300°C , -20 ... 110°C

Resolution (12-bit): 0.39°C , 0.035°C

Can be used to:

- measure the temperature inside a Bunsen burner flame or candles,
- determine the melting point of copper, bismuth, or other solids,
- measure temperature in specific heat experiments.

P-1021498



Temperature Sensor NTC with Measurement Terminal *

Temperature sensor for the measurement of temperatures on the copper tubing of a heat pump (P-1000819 / P-1000820). Temperature sensor shaft made of rust-proof stainless steel. Tip with matching copper terminal. Can be used in conjunction with VinciLab unit (1021477) for manual measurements or for processing measurement data when connected to a computer. Includes connector lead.

Range: -40 – 140°C

Resolution: 0.1°C

Accuracy: 2°C at -40°C ; 0.6°C at 30°C ; 1.8°C at 140°C

Sensor type: NTC thermistor

P-1021797





Light Sensor, Three Ranges

The light sensor BT50i measures light intensity and has three measurement ranges, which can be selected using a switch. Because of its ranges the sensor is suitable as well for indoor as for outdoor measurements. Full sun illumination is within the range of the sensor. The spectral response of the sensor approximates the response of the human eye.

Ranges: 0 ... 1500 lux, 0 ... 150000 lux, and 0 ... 150000 lux

Resolution (12-bit): 0.37 lx, 3.7 lx, 37 lx

Can be used to:

- verify inverse square law,
- investigate light reflection and absorption,
- study solar energy,
- monitor monitoring sunrise and sunset times.

P-1021502



Light Sensor *

The light sensor Q513 measures light intensity and is sensitive to the visible light spectrum and also infrared. Because of its range the sensor is suitable for measurements in normal indoor situations.

Range: 0.1 ... 10 W/m²

Can be used to:

- verify inverse square law,
- monitor change in light caused by a chemical reaction,
- measure the rapid changes of the light intensity.

P-1021503



α, β, γ-Sensor *

The radiation sensor BT70i detects alpha, beta and gamma ionizing radiation. The sensor outputs a pulse when decay is detected. Also, a clicking sound is emitted and a LED light flashes. The sensor is suitable to detect low-level radiation, emitted by e.g. potassium fertilizers or gas lantern mantles.

Range: 0 ... 1000 cps (counts per second)

Can be used to:

- monitor background radiation,
- record radioactive decay and determine half-life,
- investigate radiation versus shielding.

P-1021512



Sensor Cable

The sensor cable is used to connect sensors to the data logger. The cables are sold per piece and in packages of four .

Length: 1.5 m

P-1021514 Sensor Cable

P-1021515 Set of 4 Sensor Cables



UVA Sensor *

The UVA sensor 0388 measures the intensity of ultraviolet radiation. This sensor consists of a broadband UV sensitive silicon photodiode and responds primarily to UVA radiation.

Range: 320 ... 390 nm

Resolution (12-bit): 5 mW/m²

Can be used to:

- measure the UVA transmittance of various sunglasses and regular glasses,
- measure the UVA intensity as a function of time throughout the day,
- measure the UVA transmittance of fabrics, both wet and dry.

P-1021504



UVB-Sensor *

The UVB sensor 0389 measures the intensity of ultraviolet radiation. This sensor consists of a broadband UV sensitive silicon photodiode and responds primarily to UVB radiation.

Range: 290 ... 320 nm

Resolution (12-bit): 0.25 mW/m²

Can be used to:

- measure the UVB transmittance of various sunglasses and regular glasses,
- measure the UVB intensity as a function of time throughout the day,
- measure the UVB transmittance of fabrics, both wet and dry.

P-1021505



VinciLab Stand

Plastic stand for the VinciLab data-logger.

P-1021516



Web Cam

The USB webcam that allows capturing videos. The webcam has a built-in microphone, built-in LED lighting and a tripod is included. It is able to capture up to 30 frames per second at VGA resolution (640 x 480).

P-1021517



Extension Cable (Analog) BT-BT

Cable for extending the length of analog BT sensor cables.

Length: 5 m

P-1021500



Connection Cable MiniDIN8 – BT

The cable is used to connect the light barrier (P-1000563) and laser reflex sensor (P-1001034) to VinciLab (P-1021477).

P-1021688

MECHANICS

Experiment Topics:

- Inclined plane
- Lever laws
- Torques and forces
- Forces acting on a lever arm
- Force as a vector
- Pendulum motion
- Physical pendulum
- Fixed and movable pulleys
- Block and tackle
- Hooke's law
- Coupled resonance
- Centre of gravity
- Friction



Advantages

- Large components ensure that experiments can be viewed from a distance
- Secure attachment is guaranteed by high-grade AlNiCo magnets
- Quick and easy configuration of experiments
- Measuring units, vector diagrams and explanations can be provided right next to the experimental configuration on the blackboard

Mechanics Kit for Whiteboard

The mechanics kit for whiteboard demonstrations includes more than 25 large, coloured and easily distinguished components stored in a case with foam inlay. More than 30 experiments can be set up in rapid time.

P-1000735

Additionally recommended:

P-1002591 Whiteboard, 600x900 mm²

or

P-1002592 Whiteboard, 900x1200 mm²

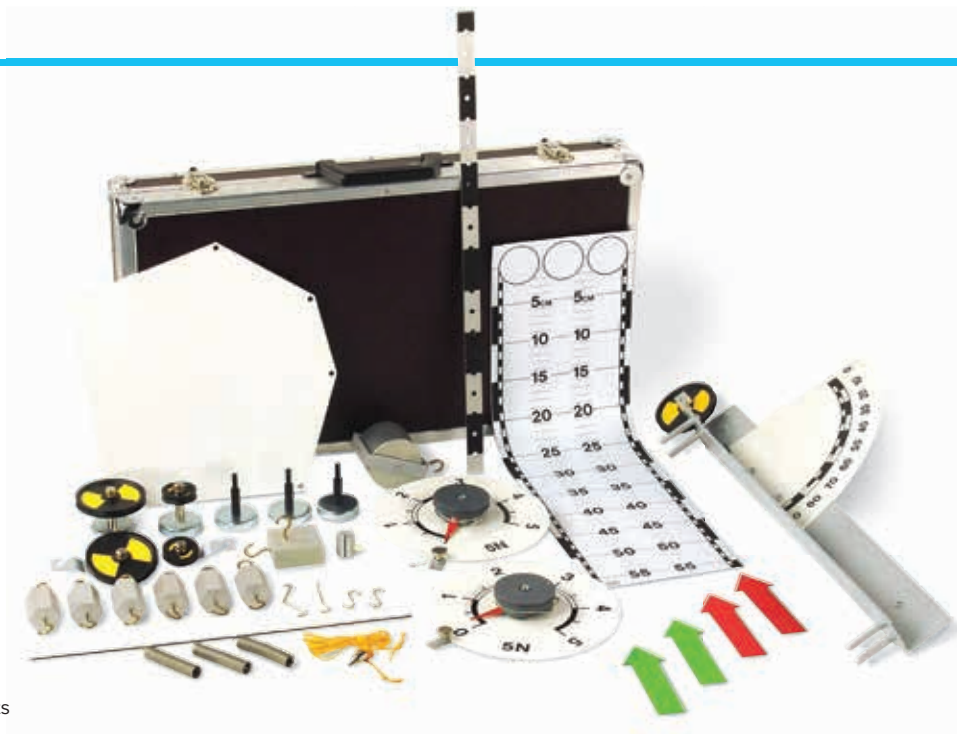

Contents:

- 1 Inclined plane with pulley and angle scale
- 1 Rolling mass, 500 g
- 1 Lever with 20 holes, 545 mm long
- 1 Pointer for lever, 400 mm long
- 1 Slotted counterweight with knurled screw, approx. 20 g
- 1 Pulley, double, 70 mm diam., 40 mm diam.
- 1 Pulley, 70 mm diam.
- 1 Pulley, 40 mm diam.
- 2 Round scale dynamometers, 5 N
- 3 Magnetic tabs with 8 mm axis
- 3 Springs with hook, $k = 6.2 \text{ N/m}$
- 1 Dual scale on a magnetic foil, 600x180 mm²
- 4 Arrows and one equilateral triangle on a magnetic foil
- 6 Weights with 2 hooks, 100 g each
- 1 Friction block
- 1 Set of nylon cords
- 1 Centre-of-gravity plate
- 1 Plumb
- 3 Rubber grommets
- 3 Brass hook
- 1 Brass clip
- 1 Storage case
- 1 Manual

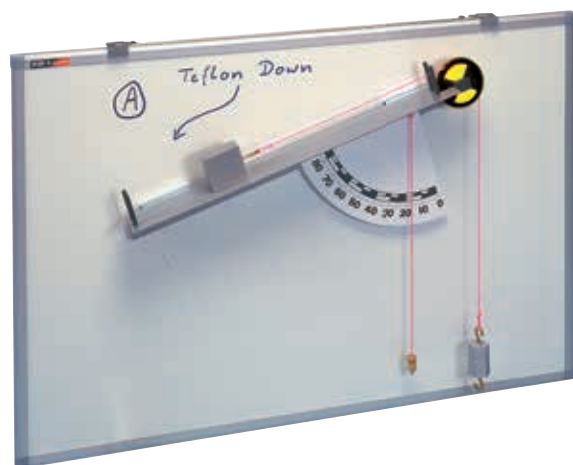

Friction on an inclined plane

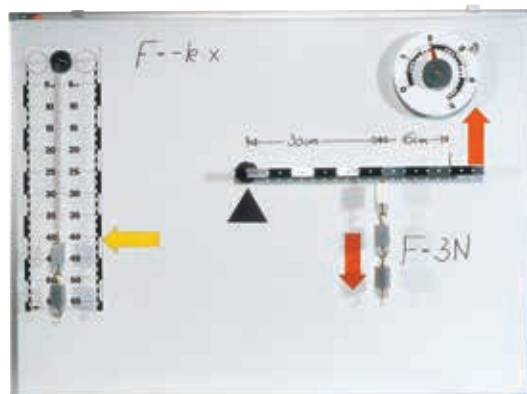

Hooke's law; second and third class levers



Mechanical Cumulative Stopwatch

Cumulative stopwatch with start, stop and reset buttons in shock-resistant plastic casing. Dual dial for minutes and seconds. With pendant cord.

Measuring range: 15 min
Scale accuracy: 1/10 s
Diameter: 55 mm

P-1002810



Digital Stopwatch

Stopwatch with 7-digit LCD display in robust plastic casing with start/stop and split/reset buttons for starting and stopping, cumulative, lap-time and dual-time measurement. Includes pendant cord.

Measuring range: 9 h, 59 min, 59 s, 99/100 s
Accuracy: 1/100 s
Battery: button cell 1.55 V, Type 389
Dimensions: approx. 65x65x18 mm³

P-1002811



Mechanical Stopwatches

Stopwatch in stainless steel casing with dual dial for minutes and seconds. In pouch with pendant cord.

Art. No.	Measuring range	Reading accuracy	Diameter
P-1003368	30 min	0.2 sec	45 mm
P-1003369	15 min	0.1 sec	45 mm



For measuring times when, e.g. a swinging pendulum obscures a sensor

Table-Top Stop-Clock

Large quartz-controlled stop-clock with start stop and reset buttons, cumulative time and lap-time settings (clock resets to zero and starts timing again immediately). 2 hands, dial with dual scale for minutes/seconds and hundredths of a minute.

Measuring range: 60 min / 60 s
Graduations: 1 s / 1/100 min
Dial: 110 mm diam.
Dimensions: approx. 175x130x95 mm³

P-1002809

Timer

Stopwatch for counting up or down with acoustic alarm. Magnetic holder for attachment to metal surfaces and fold-away support legs.

Display: 4-digit LCD, 18 mm
Timer range: 99 min 59 s
Ticking rate: 1 s
Dimensions: approx. 60x60x20 mm³

P-1003009

Digital Counter

We recommend the use of the digital counter (P-1001033 or P-1001032) along with one or two photo gates (P-1000563) for reliable measurement of the time a carriage on a track takes to cover a distance or when it obscures the light sensors. Also suitable for measuring oscillation periods of a swinging pendulum or similarly the times when it obscures the sensors. As an alternative to a light barrier, a laser reflection sensor (P-1001034) can also be used for the opto-electronic sampling of light and dark markings on moving objects or can be used as a long-distance light barrier when connected in conjunction with reflective foil.

Digital Counter (230 V, 50/60 Hz)

P-1001033

or

Digital Counter (115 V, 50/60 Hz)

P-1001032

Photo Gate

P-1000563

or

Laser Reflection Sensor

P-1001034



Vertical Ruler, 1 m

Ruler with fastening pin (d = 12 mm) so that it can be set up vertically in a stand base. Scale as per P-1000742.

P-1000743

Set of Riders for Rulers

The set of riders consists of two red plastic pointers to match rulers P-1000742 and P-1000743 that can be used as movable cursors.

Dimensions: 120x40x20 mm³

P-1006494



UE1010200
PDF online



External Micrometer

Precision micrometer with thimble and locking system. Measuring surfaces coated with hardened metal, polished with fine lapping. Tempered measuring spindle with polished thread, chromed micrometer arc with insulation, scale drum and sleeve in matt-chrome finish. In plastic pouch.

Measuring range: 0 – 25 mm

Graduation: 0.01 mm

P-1002600

Precision Spherometer

For measuring plate thicknesses, depressions and radii of curvature of spherical surfaces, for example, lenses. The device consists of a tripod with three steel tips which form an equilateral triangle. A micrometer screw with a measuring tip is recessed in the middle. Attached to the micrometer screw is a disc with circular divisions from 0 to 500 and a vertical scale with millimeter divisions from -10 to 15 mm at the tripod.

Measuring ranges: 0 – 25 mm and -10 – 15 mm

Screw pitch: 0.5 mm

Measuring accuracy: 0.001 mm

Support spacing: 50 mm

P-1002947

Additionally recommended:

P-1003190 Plane Mirror



Pocket Measuring Tape, 2 m

Made of spring band steel, with locking button and rewinding spring.

Length: 2 m / 79 inch

Scales: cm, mm / 1/32 inch

P-1002603



Ruler, 1 m

Wooden ruler with mm scale on one side and two-coloured cm scale on the reverse.

Cross section: 25x8 mm²

P-1000742



Callipers S

Inexpensive callipers with 125 mm scale suitable for measuring internal and external dimensions and depths.

P-1010217



Digital Callipers, 150 mm

For measuring internal and external dimensions and depth. Tempered stainless steel, LCD display. Including locking screw, adjustment from cm to inch, zero point adjustment in any position, with plastic pouch.

Measuring range: 150 mm / 6 inch

Graduation: 0.01 mm / 1/128 inch

Display: 5-digit LCD, 6 mm

P-1002602



Callipers, 150 mm

Precision callipers for measuring internal and external dimensions and depth. Tempered stainless steel, precision polished measuring surfaces, gauge with matt-chrome finish. In imitation leather pouch.

Measuring range: 150 mm / 6 inch

Graduation: 1/20 mm / 1/128 inch

P-1002601

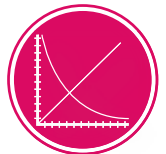

UE1010100
PDF online

Watch Glasses from P-1002868 and P-1002869



Callipers Model
 Model of a set of callipers suitable for measuring internal and external dimensions and depths of up to 300 mm.
 Dimensions: approx. 420x195 mm²
P-1010214

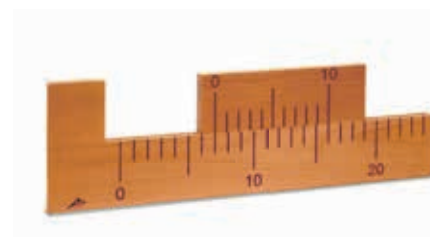

Vernier Model
 For demonstrating Vernier readings on length measuring devices and protractors.
 Length: 600 mm
 Vernier length: 260 mm
 Height: 190 mm
P-1002951



Object for Measurement Exercises
 Irregularly shaped body, which is especially well suited for practising measurement using Vernier callipers.
P-1006889



Wooden Rulers
 These wooden rulers are a classroom staple.

Wooden Ruler, 1 m, Set of 10
P-1003233



Vessel with Overflow, Transparent
 Vessel with overflow, 275 ml, made of Plexiglas.
P-1003518

Laser Range Finder

Professional laser range finding instrument with multi-lined LCD display and background illumination especially designed for distance measurements of extremely high precision and for locations difficult to access.

Speed buttons for:

- Range measurements up to maximum 60 m
- Indirect measurement (according to Pythagoras)
- Area and volume calculation
- Addition and subtraction operations
- Continuous, MIN and MAX measurements
- Self-timer measurement function from 1 sec. up to 60 sec.

With internal memory for 99 recorded measurement values, retractable 90° bracket for precise targeting of the measurement point, spirit level and tripod socket.

Including case, batteries and instruction manual.

Measurement range: 0.05 – 60 m
 Measurement units: m (metre), in (inch), ft (feet)
 Accuracy: ± 2 mm
 Internal memory: 99 values
 Laser: 620 nm – 680 nm, <1 mW, class: 2
 Operating voltage: 2x 1.5 V AAA batteries
 Display: Multi-lined multifunction display
 Dimensions: approx. 118x54x28 mm³
 Weight: approx. 135 g

P-1020907

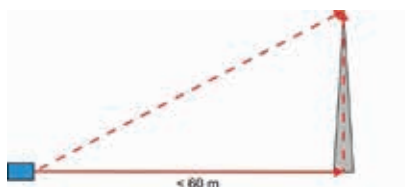



Advantages

- Precision
- Easy to read
- Colour coding

Precision Dynamometer

Colour coded precision dynamometer in a transparent plastic casing with easy-to-read scale, protection against over extension of the spring and zero-point calibration capability.

Precision: < 1% of total measuring range
 Scale division: 1% of total measuring range
 Dimensions: 280 mm x 16 mm diam.

Art. No.	Colour	Measuring range
P-1003102	Silver	0.1 N
P-1003103	Beige	0.2 N
P-1003104	Yellow	1 N
P-1003105	Red	2 N
P-1003106	Blue	5 N
P-1003107	Green	10 N
P-1003108	Violet	20 N
P-1003110	Brown	100 N



Dynamometer, Colour Coded

Colour coded dynamometer for measuring weights or masses as well as forces. Scaled in newtons or grams and kilograms with zero-point calibration.

Art. No.	Colour	Measuring Range	Scale Division
P-1003370	Blue	250 g / 2.5 N	5 g / 0.05 N
P-1003371	Green	500 g / 5 N	10 g / 0.1 N
P-1003372	Brown	1000 g / 10 N	20 g / 0.2 N
P-1003373	Red	2000 g / 20 N	50 g / 0.5 N
P-1003374	White	3000 g / 30 N	50 g / 0.5 N
P-1003375	Yellow	5000 g / 50 N	100 g / 1 N

Dynamometer with Round Dial

Spring dynamometer for experiment demonstrations. Grooved pulley on ball bearings and cord with hook. Large, easily read round dial. Zero-point adjustment by turning the dial. With magnet for attachment to a whiteboard. Diameter: 200 mm

Art. No.	Measuring range	Scale Division
P-1009738	1 N	0.02 N
P-1009739	2 N	0.05 N
P-1009740	5 N	0.1 N
P-1009741	10 N	0.1 N





Set of Helical Springs for Hooke's Law

5 helical springs with a hook and an attached pointer for determining spring constants

P-1003376

Spring constant	2.5 N/m	5 N/m	10 N/m	15 N/m	25 N/m
Length	122 mm	145 mm	150 mm	147 mm	142 mm
Diameter	15 mm	15 mm	19 mm	20 mm	20 mm

Additionally recommended:

P-1003227 Set of Slotted Weights 10 g

P-1000743 Vertical Ruler

Stand equipment



Dynamometers for Demonstrating Hooke's Law

Two colour coded dynamometers in transparent plastic sleeve with easy-to-read cm/mm scale for demonstrating Hooke's law and calculating the spring constant. Protection against over extension of the spring and zero-point calibration.

Spring constants: 10 N/m and 20 N/m

Length of scale: 115 mm

Dimensions: 280 mm x 16 mm Ø

P-1003109

Additionally recommended:

P-1003227 Set of Slotted Weights 10 g

P-1000743 Vertical Ruler

P-1006494 Set of Riders for Rulers

Stand equipment



Helical Springs

For experiments on expansion and oscillation, with two suspension eyelets. Tolerance 10%.

Art. No.	Spring constant	Length	Diameter
P-1000786	1.5 N/m	120 mm	20 mm
P-1003515	2.5 N/m	120 mm	16 mm
P-1002945	3.9 N/m	30 mm	34 mm
P-1000741	5 N/m	60 mm	20 mm
P-1002702	16 N/m	115 mm	6 mm
P-1002703	43 N/m	110 mm	9 mm
P-1002946	20 N/m	180 mm	8 mm
P-1002704	86 N/m	95 mm	10 mm



Set of 10 Weights

Brass weights with hooks on both sides so that they can be suspended from one another.

**Set of 10 Weights, 10 g
P-1000770**

**Set of 10 Weights, 20 g
P-1000769**

**Set of 10 Weights, 50 g
P-1000771**



Set of Weights 1 g to 50 g

8-piece set of brass weights, delivered in storage box. 1x 1 g, 2x 2 g, 1x 5 g, 2x 10 g, 1x 20 g, 1x 50 g
P-1003210



Sets of Slotted Weights on Weight Holder
Slotted brass weights and holder.

Art. No.	Designation	Weights (incl. holder)	Holder diam.
P-1003226	Set of slotted weights, 20 – 100 g	2x 5 g, 1x 10 g, 4x 20 g	22 mm
P-1003227	Set of slotted weights, 10x 10 g	10x 10 g	18 mm
P-1003229	Set of slotted weights, 5x 50 g	5x 50 g	32 mm
P-1003228	Set of slotted weights, 5x 100 g	5x 100 g	38 mm



Set of Weights 1 g to 500 g, slotted with Holder

13-piece set of brass weights on convenient storage rack. 1x 1 g, 2x 2 g, 1x 5 g, 1x 10 g, 2x 20 g, 1x 50 g, 1x 100 g, 2x 200 g, 1x 500 g, holder 50 g
P-1018597



Set of Weights, 1 g to 1000 g

13-piece set of brass weights in storage block. 1x 1 g, 2x 2 g, 1x 5 g, 1x 10 g, 2x 20 g, 1x 50 g, 1x 100 g, 2x 200 g, 1x 500 g, 1x 1000 g
P-1003212



Set of Weights 10 g to 1000 g

9-piece set of brass weights in storage box, each with hooks on both sides. 1x 10 g, 2x 20 g, 1x 50 g, 1x 100 g, 2x 200 g, 1x 500 g, 1x 1000 g
P-1003214



Set of Weights 100 g to 2000 g

7-piece set of weights with hooks. 1x 100 g, 2x 200 g, 1x 500 g, 2x 1000 g, 1x 2000 g
P-1001052



Set of Weights 1 mg to 500 mg

Set of 12 aluminium weights in a plastic box. 1x 0.5 g, 2x 0.2 g, 1x 0.1 g, 1x 0.05 g, 2x 0.02 g, 1x 0.01 g, 1x 5 mg, 2x 2 mg, 1x 1 mg.

P-1010234



Set of Weights 1 g to 500 g

12-piece set of brass weights in storage block. 1x 1 g, 2x 2 g, 1x 5 g, 2x 10 g, 1x 20 g, 1x 50 g, 2x 100 g, 1x 200 g, 1x 500 g.

P-1010189



Set of Three Weight Holders with Slotted Weights

Slotted brass weights on holder comprising 3 sets with 2x 5 g, 2x 10 g, 2x 20 g, 3x 50 g.

P-1000676



Beam Balance with Metal Bridge

Beam balance on hard plastic base plate. Aluminium beam on steel needle bearing with adjustment screws. Removable stainless steel balance pans. Usable also for hydrostatic experiments in connection with metal bridge and Archimedes cup (P- 1021647).

Maximum load: 500 g
Resolution: 50 mg
Pans: 120 mm diam.

P-1021824

Additionally recommended:

P-1010189 Set of Weights 1 g to 500 g

P-1010234 Set of Weights 1 mg to 500 mg



Set of Weights with Hooks

11-piece set of weights with hooks on both sides so that they can be suspended from one another. Tolerance: 10%.

1x 1 g, 2x 2 g, 1x 5 g, 2x 10g, 1x 20 g, 1x 50 g, 2x 100 g, 1x 200 g.

P-1010168

Bench Scales, Harvard Junior

Inexpensive and colourful two-pan scales made of plastic. No less stable or accurate than many more expensive scales. With high-precision manufactured metal beam, interchangeable pans and zero adjustment. Includes a set of 8 weights. Built-in interlock to protect against vibration during transport or during long-term storage. Stackable.

Maximum load: 2 kg
Precision: 0,5 g
Pans: 150 mm diam., plastic, shallow and high-sided versions

Set of weights: Set of 8, 370 g

P-1012872



Experiment Topics:

- Determining initial equilibrium position of a torsion pendulum
- Recording of damped oscillations around the final equilibrium position of a torsion pendulum over time
- Determining final equilibrium position of a torsion pendulum by final deflection method
- Determination of gravitational constant G from the period of oscillation and the difference between the equilibrium positions
- Determination of gravitational constant G by acceleration method



Oscillation about the two equilibrium positions



UE1010300
PDF online

Cavendish Torsion Balance

A Cavendish torsion balance demonstrates the force of gravity between two masses and allows the gravitational constant to be determined. Thanks to the short oscillation period of just 2 – 4 minutes, the gravitational constant can be determined within the space of a single lesson with an accuracy of better than 10%. The core of the apparatus is a torsion pendulum made of a light bar with two small lead spheres, which is suspended horizontally from a thin wire. The apparatus is moved from its equilibrium position by the attraction of the two spheres to two larger lead spheres. When the two large spheres are rotated to a new position, the torsion balance will oscillate about a new equilibrium position. The rotary motion is measured using a capacitive differential sensor, which largely suppresses noise and vibration components in the signal. The output is then recorded using a computer. For subsequent evaluation, the data can be exported to a spreadsheet. Alternatively, the motion can be demonstrated with the aid of a light pointer.

Mass of large lead spheres:	1 kg
Mass of small lead spheres:	15 g
Gravitational attraction:	$< 10^{-9}$ N
Torsion wire:	Tungsten, 25 μ m
Period of oscillation:	2 – 4 mins
Angular resolution:	25 microradians
Sampling rate:	0.5, 1, 2, 5, 10 samples/s
Dimensions:	approx. 190x180x200 mm ³
Weight:	approx. 5 kg

Includes:

- 1 Cavendish torsion balance
- 1 Measurement software
- 1 USB cable

P-1003337

Additionally recommended:

P-1003201 Diode Laser, Red 650 nm
Stand equipment

Tungsten Wire (not shown)

Roll of torsion wire for Cavendish torsion balance (P-1003337).

Diameter: 25 μ m

P-1009718

Experiment Topics:

- Day and night
- Seasons
- Phases of the moon
- Solar and lunar eclipses and their cycles



Orbit™ Tellurium

Attractive and easy-to-operate three-dimensional model of the sun, moon and earth, for comprehensive demonstration of their motions. Earth and moon in two different sizes in order to demonstrate day and night, motion of the sun across the sky, annual seasons, the changing amounts of daylight, phases of the moon, as well as solar and lunar eclipses and the cycles they exhibit. Shadows have clear edges since the sun is represented by a bright lamp with a Sunbeam™ reflector. As an alternative to turning the whole system together, the rotation of the earth on its axis and the position of the moon in its orbit can be adjusted individually by hand.

Dimensions: approx. 650x250x300 mm³

Includes:

Tellurium with earth and moon in two sizes; display cards showing dates, solar eclipses, lunar eclipses and phases of the moon; small figure; sundial; detailed instructions in English; mains transformer, 100 – 240 V/6V

P-1008661



Advantages

- Greater reading accuracy thanks to having two angle scales
- Can be extended to feature four force components



Force Table

Equipment for quantitative investigation of the combination and resolution of forces, consisting of a circular workplate on a stable base with dual protractor scale. Weights from set of three weight holders with slotted weights P-1000676 (included), are suspended from 3 cords strung over pulleys with ball bearings.

Dimensions: approx. 300 mm x 390 mm Ø
 Weight: approx. 3,1 kg

P-1000694

Additionally recommended:

P-1000699 Extra Pulley

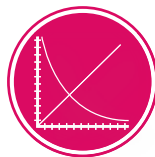

UE1020300
 PDF online



Universal Spirit Level, 250 mm

Spirit level made of shock resistant plastic for measuring angles to horizontal, vertical and inclined planes and for joinery. With two plexiglass level gauges, resistant to breakage and leakage. Horizontal gauge built-in and accurately calibrated. Gauge for measuring inclination can be rotated and fixed in place. Scale markings for 45°, 60° and 120°, mm scale on measuring surface, protractor scale for inclination gauge.

Scales: 250 mm/1 mm, -90° – +90°/2°
 Dimensions: approx. 250x54x15 mm³

P-1002604



Extra Pulley

Additional pulley for use with the force table (P-1000694) with clamp, cord and holder with set of slotted weights 2x 5 g, 2x 10 g, 2x 20 g and 3x 50 g.

P-1000699



Plumb with Line

Brass body with a line.

Height: 100 mm
 Diameter: 20 mm
 Weight: 220 g
 Line length: 1600 mm

P-1002940



Centre-of-Gravity Plate

Plastic plate with 6 boreholes for introducing the concept of centre of gravity and determining centroids.

P-1008513

Additionally required:

P-1002940 Plumb with Line



Stability Apparatus

For demonstrating the stability of an object as a function of the position of its centre of gravity above the supporting surface. The position of the centre of gravity can be adjusted by tilting the device. The position of the centre of gravity over the base of the stand is indicated by a built-in plumb bob.

Dimensions: approx. 180x150x290 mm³

P-1002950

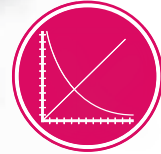
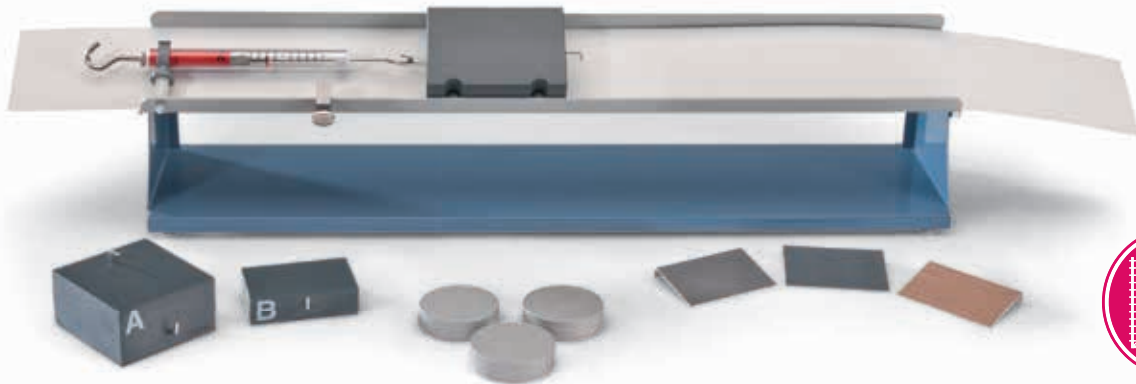

UE1020500
PDF online



Advantages

- Complete apparatus: additional accessories not required
- Robust, durable

Friction Measuring Apparatus

Demonstration apparatus with movable friction surface for measuring static and dynamic friction between two surfaces as a function of area, force between the surfaces or the combination of materials. For easy measurement of dynamic friction, the movable surface is moved at constant speed under a static body connected to a dynamometer. The friction track can be inclined along its length in order to vary the force between the two surfaces.

Dimensions: approx. 600x140x150 mm³
Weight: approx. 3 kg

Contents:

Basic apparatus with movable friction surface, 2 N dynamometer, three different static bodies, three rails for holding static bodies, three 100 g weights.

P-1009942



Precision Dynamometer

Colour coded precision dynamometer in a transparent plastic casing with easy-to-read scale, protection against over extension of the spring and zero-point calibration capability.

Precision: < 1% of total measuring range
Scale division: 1% of total measuring range
Dimensions: 280x16 mm diam.

Art. No.	Colour	Range
P-1003104	Yellow	1 N
P-1003105	Red	2 N
P-1003107	Green	10 N

Block for Friction Experiments

Aluminium block with a teflon-coated surface and 2 hooks.

Dimensions: approx. 55x50x25 mm³

P-4003876

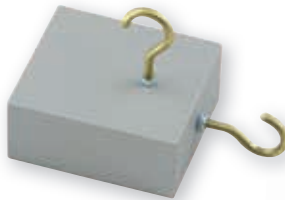

Wooden Blocks for Friction Experiments

Two wooden blocks with plastic coated surfaces and hook for attaching a dynamometer.

Dimensions: approx. 120x60x60 mm³ and 120x60x30 mm³

P-1002944



Additionally recommended:

P-1003104 Precision Dynamometer, 1 N

P-1003105 Precision Dynamometer, 2 N

P-1003107 Precision Dynamometer, 10 N

P-1003212 Set of Weights, 1 g to 1000 g





Experiment topics:

- Fixed pulley
- Movable pulley
- Block and tackle
- Wheel on axle

Experiment Set Pulleys and Block and Tackle

For demonstrating how forces can be altered in direction and distributed over an area by simple machines (fixed and movable pulleys, block and tackle) and introducing the concepts of mechanical work, power and energy. Complete set of equipment consisting of a stable base plate, retort stand rods, pulley blocks, block and tackle, a set of pulleys of various diameters on an axle, weight holders, slotted weights and a reel of cord. All the experiments can be set up quickly and easily since the closed plastic frame around the pulleys prevents the cord from slipping.

- | | |
|------------------|--|
| Base plate: | approx. 810x200 mm ² |
| Pulleys: | 50 mm diam. |
| Stand rods: | 810 mm x 12,5 mm diam. |
| Slotted weights: | 2x 10 g, 2x 20 g, 2x 50 g, 4x 100 g, 4x 200 g,
1x 500 g |
| Holders: | 1x 10 g, 1x 20 g, 5x 50 g |

Contents:

- 1 Base plate
 - 3 Stand rods
 - 2 Plastic clamps
 - 1 Universal sleeve
 - 8 Hooks
 - 7 Pulley blocks with 1 pulley
 - 2 Pulley blocks with 4 pulleys
 - 2 Tandem pulley blocks with 3 pulleys
 - 1 Wheel on axle
 - 15 Slotted weights
 - 7 Weight holders
 - 1 Reel of cord
 - 1 Screw pin
- P-1003224**

Additionally required:

- P-1002603 Measuring Tape, 2 m**
- P-1002700 Dynamometer 5 N**
- P-1003369 Mechanical Stopwatch, 15 min**



Pulleys and Block and Tackle

For experiments with fixed and movable pulleys. Non-deformable, low-friction pulleys with cord grooves and hooks at the ends of both axles for suspending from fixed supports or other pulleys. The enclosed design of the plastic frame prevents the cord from slipping off the pulley.

Art. No.	Designation	Pulleys	Diameter	Material
P-1003216	Pulley block	1	50 mm	plastic
P-1003217	Pulley block	2	50 mm	plastic
P-1003218	Pulley block	3	50 mm	plastic
P-1003222	Tandem pulley	2	37/50 mm	aluminium
P-1003223	Tandem pulley	3	25/37/50 mm	aluminium



Pulley with Table Clamp

Pulley for altering the direction of forces. Plastic pulley with ball bearings and cord groove plus securing clamp. Also has a bore so that it can be attached to a retort stand of up to 12.5 mm diameter.

Pulley: 50 mm diam.
Span of bracket: up to 35 mm span
P-1003221



Lever

Complete set of equipment for demonstrating laws of leverage and for experiments on equilibrium. Consists of a retort stand to which is attached a lever mounted on ball bearings with three rows of holes for adjusting the axis of rotation or for suspending weights, red and white block scale with pointer for accurate display of equilibrium state. Can also be used to model balance scales. Includes set of weights 10x 50 g.

Length of lever: 1 m
Mass of lever: 0.458 kg
Number of holes: 21
Separation of holes: 50 mm

P-1008539

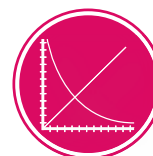

UE1020200
PDF online

Inclined Plane

Equipment for investigating forces acting on a body on an inclined plane, and determining the holding friction as a function of the angle of inclination. Metal base and inclined plane. The plane is hinged with scales for angle, length and height. Angle of inclination can be adjusted between 0 and 45°. Includes adjustable pulley, roller, weight pan and cord.

Length of inclined plane: 600 mm
Length of base: 450 mm
Scales: divided into cm or degrees

P-1003213

Additionally recommended:

P-1002701 Dynamometer, 10 N

P-1010189 Set of Weights 1 g to 500 g



UE1020400
PDF online

Experiment Topics:

- Regular movements and movements with uniform acceleration
- Newton's laws of motion
- Conservation of energy
- Elastic and inelastic collisions

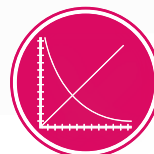

UE1030250
PDF online

Trolley Track

Track with two trolleys and other accessories for investigating linear motion, plus three adjustable point supports for setting horizontal alignment. The trolleys move with minimum friction on wheels with high-quality ball-bearings. They are fitted with magnets at their front ends for experiments involving both elastic and inelastic collisions. Including a spoked wheel suitable for use as a pulley with the trolley track. It can be used in combination with a light barrier (P-1000563) for recording the motion of a trolley.

Mass of trolleys: 500 g
 Length of distance scale: 1800 mm
 Overall length: 1800 mm

Contents:

- 1 Track, 1.8 m
- 1 Two-point support
- 1 Single point support with end stop
- 1 Trolley
- 1 Trolley with interchangeable buffer pad
- 1 Additional weight, 500 g
- 2 Holder for light barrier
- 1 Holder for pulley
- 1 Pulley
- 1 Clamp for stand rods
- 1 Set of contact-breakers
- 1 Set of magnets

P-1018102

Additionally recommended:

- P-1007112 Cord, 100 m
- P-1003227 Set of Slotted Weights, 10x 10 g
- P-1000563 Photo Gate
- P-1021477 VinciLab
- Software Coach 7

- P-1007112 Cord, 100 m
- P-1003227 Set of Slotted Weights, 10x 10 g
- P-1000559 Ultrasonic Motion Sensor
- P-1021477 VinciLab
- Software Coach 7

- P-1007112 Cord, 100 m
- P-1003227 Set of Slotted Weights, 10x 10 g
- P-1000563 Photo Gate (2x)
- P-1021477 VinciLab
- Software Coach 7

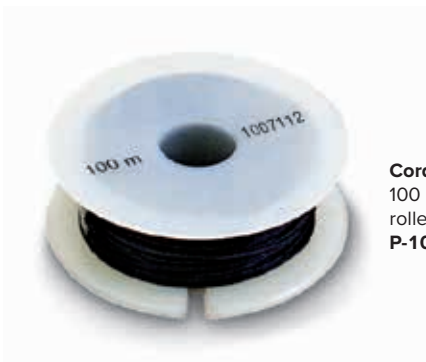
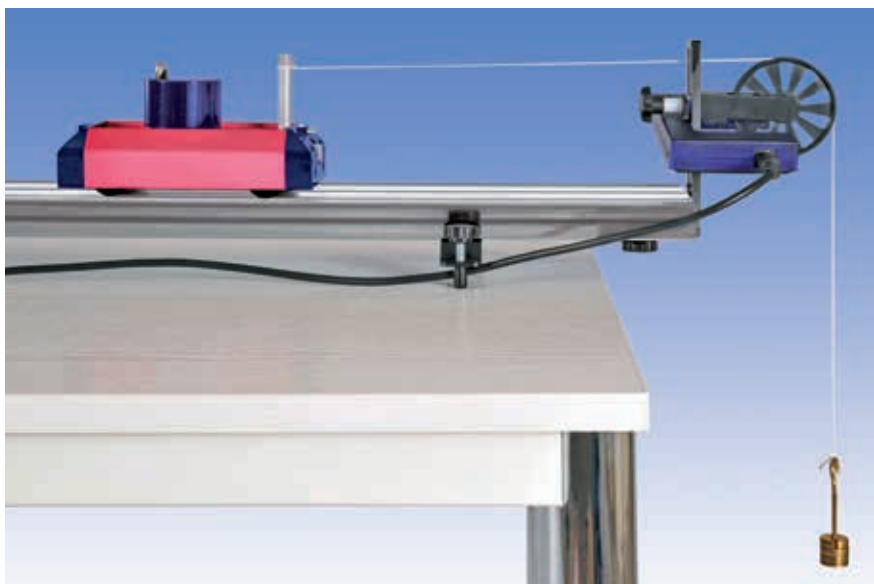

Cord, 100 m
 100 m length of hemp string, black, rolled onto bobbin.
P-1007112

Experiment Topics:

- Regular movements and movements with uniform acceleration
- Newton's equations of motion
- Laws on the conservation of momentum and energy
- Elastic and inelastic collisions
- Motion on an inclined air track

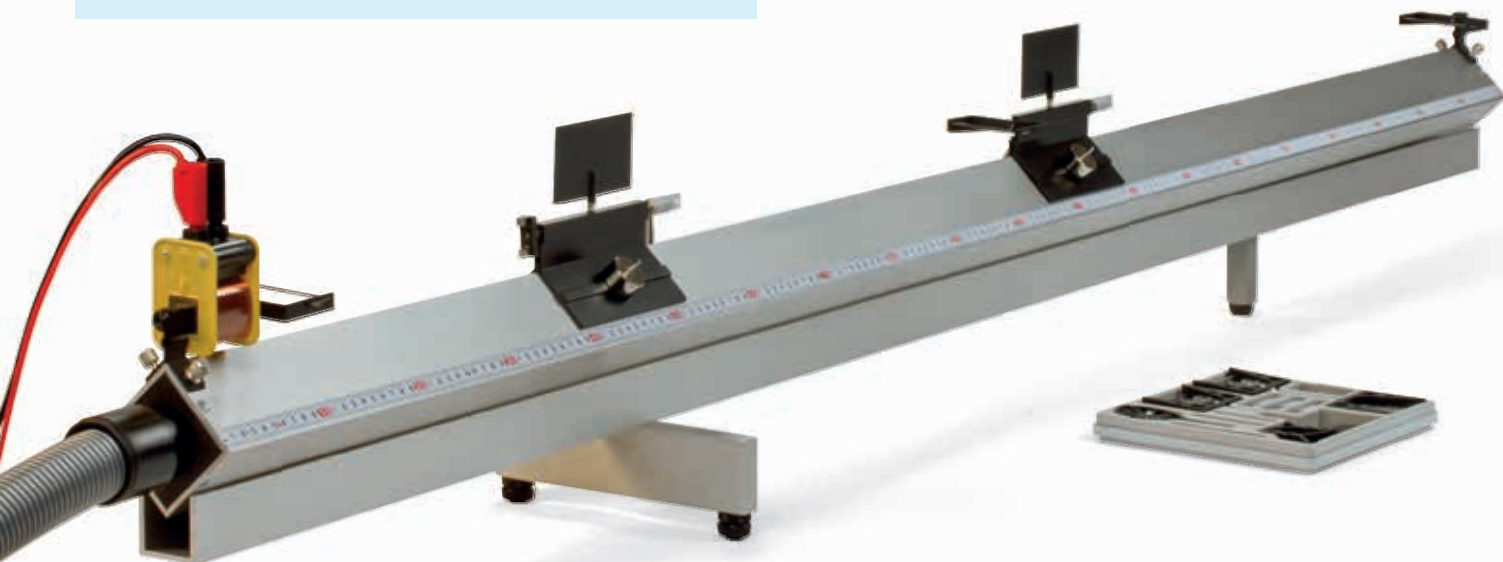

Advantages

- Track cannot bend (on stable support with U-shaped profile)
- Length of track 1.9 m
- Sliders move with almost zero friction

Air Track

Track with square profile and 2 gliders for investigating frictionless linear motion. Mounted on a robust U-shaped base resting on three feet that can be adjusted to ensure horizontal alignment. The air is blown in from the front and escapes through small air outlets arranged in 2 rows along the track. This allows for practically frictionless movement of the gliders on the triangular track with no tilting. With millimetre tape measure.

Material:	Anodised aluminium
Total length:	2.00 m
Working length:	1.90 m
Maximum deviation from straight line over complete length:	0.02 mm
Track profile:	Square, 63x63 mm ²
Thickness of walls:	3 mm
Separation of air outlets holes:	20 mm
Base profile:	U-shaped profile
Width of base:	100 mm
Height of base:	50 mm
Wall thickness of base:	5 mm

Contents:

- 1 Air track on U-shaped base profile resting on three feet
- 2 Gliders made of black anodised aluminium with 4-mm holes to accommodate velocity flags and other accessories, plus pins at the sides to hold additional weights, mass: 180 g, length: 125 mm
- 4 Additional 50 g weights
- 1 Set of slotted weights with holder, 2x 1 g, 1x 2 g, 1x 5 g, 1x 10 g, holder 2 g
- 2 Velocity flags with plug for interrupting light barriers, mass: 5 g, width: 25 mm
- 3 Forks with plugs and rubber bands for catapulting gliders and investigating elastic collisions, mass: 10 g
- 3 Plates with plugs for investigating elastic collisions, mass: 10 g
- 1 Needle with plug for investigating inelastic collisions, mass: 10 g
- 1 Small tube with plug and plastic filling for investigating inelastic collisions, mass: 10 g
- 1 Hook with plug for attaching a thread with accelerating weights on the end, mass: 10 g
- 1 Pulley for frictionless deflection of accelerated masses
- 1 Set of screws and tools for assembling air track
- 1 Manual

P-1021090

Additionally required:

- P-1000606 Air Flow Generator (230 V, 50/60 Hz)**
or
P-1000605 Air Flow Generator (115 V, 50/60 Hz)

Additionally recommended:

- P-1000563 Photo Gate**
P-1001033 Digital Counter (230 V, 50/60 Hz)
or
P-1001032 Digital Counter (115 V, 50/60 Hz)
P-1019300 Electromagnetic Launch Apparatus
P-1019301 Switch Box
P-1003312 DC Power Supply 0 – 20 V, 0 – 5 A (230 V, 50/60 Hz)
or
P-1003311 DC Power Supply 0 – 20 V, 0 – 5 A (115V, 50/60 Hz)
Stand equipment
Experiment leads



Air Flow Generator

Fan allowing continuous adjustment of air flow. Includes a hose.

Hose length: approx. 1.5 m
 Power consumption: max. 1100 W
 Dimensions: approx. 300x180x170 mm³
 Weight: approx. 4.4 kg

**Air Flow Generator (230 V, 50/60 Hz)
 P-1000606**

**Air Flow Generator (115 V, 50/60 Hz)
 P-1000605**



Switch Box

Control unit which is used in conjunction with the electromagnetic launch apparatus to shut off the current and simultaneously send a signal to a connected counter/timer.

Power supply: 8 V DC
P-1019301



Set of Hook Weights and Thread

Set of propulsion weights and thread for acceleration of sliders on air-cushion track. Consisting of 3 S-shaped hooks, 1 g, 5 S-shaped hooks, 2 g, and 1 roll of sewing thread.

P-1019180



Electromagnetic Launch Apparatus

Used along with a catapult assembled from a fork and rubber band included in the air track set, the launch apparatus imparts uniform, reproducible launch momentum to a glider which is dependent on the tension in the rubber band. It consists of an iron core, a solenoid coil and an armature. The iron core is attached to the end of the air track where it provides a mount for the coil. The glider is connected to the coil via the armature and catapult. When the current is interrupted, the tensed rubber band imparts energy to the glider. A switch box (P-1019301) is used to activate the system.

Iron core: 20x20x51 mm³
 Coil: 400 turns
 Power supply: 8 V DC

P-1019300

Additionally recommended:

P-1019301 Switch Box

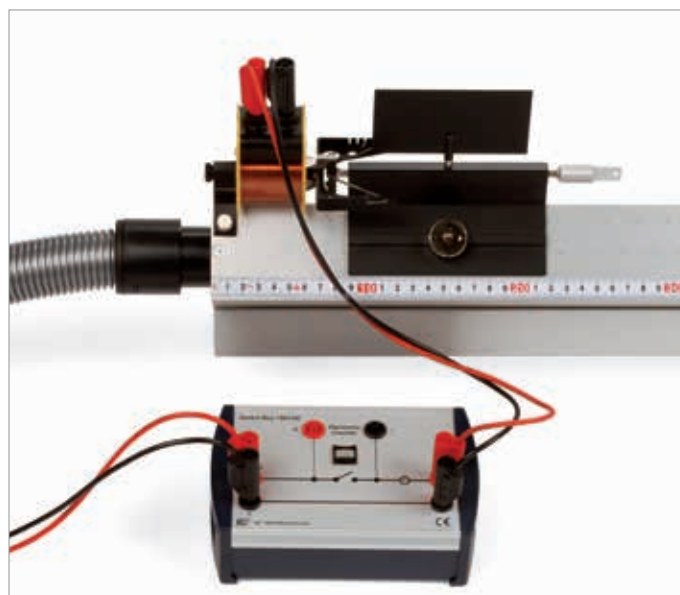

Experiment Topics:

- Newton's equations of motion
- Uniform motion in a straight line
- Motion with uniform acceleration
- Centre of mass motion
- Motion on circles and parabolas
- Inclined planes
- Conservation of momentum and energy
- Elastic and inelastic collisions between objects of equal and unequal mass



Advantage

- Newton's equations of motion
- Uniform motion in a straight line
- Motion with uniform acceleration
- Centre of mass motion
- Motion on circles and parabolas
- Inclined planes
- Conservation of momentum and energy
- Elastic and inelastic collisions between objects of equal and unequal mass



Air Cushion Platform with Inkjet Pucks

The air cushion platform is made of matt black aluminium with a stabilising honeycombed interior structure. It is equipped with profile rails on both sides for the attachment of accessories. The feet which can be adjusted for height allow the platform to be aligned such that it is precisely horizontal. The surface of the platform has rubber edging with four holders at the corners to keep it stretched in place. Inside the inkjet pucks there is a micropump motor which generates compressed air. This emerges from the underside of the pucks so that they float across the recording paper on a cushion of air. Power is supplied to the pucks from built-in, but replaceable NiMH rechargeable batteries rated at 9 V, 300 mAh. A display of the charge status and the connectors for the charging cable are located on the top of the pucks. The motion of the pucks is recorded by an inkjet onto standard DIN A1 paper lying on a table top. The pucks also contain a conventional print cartridge. Motions recorded for the two pucks can be distinguished by selecting two different colours, red or black. There is also an option to follow the motion with the help of a high-speed camera (not included). For this purpose the pucks are equipped with bi-coloured LEDs whereby the colours are selectable. Recording is stopped and started by means of an infra-red remote control. The time difference between pulses can be set to between 20 and 100 ms in steps of 5 ms. Two special boards with moistening pads provide storage for the pucks after use and prevent the ink from drying out. A lockable, airtight storage box allows the print cartridges to be stored separately from the pucks for longer periods when they are out of use.

Contents:

- 1 Air cushion platform, 935x750 mm²
- 50 Sheets of paper, DIN A1
- 2 Inkjet pucks, diameter 100 mm, height 95 mm, weight not including battery and print cartridge 660 g approx.
- 1 Black print cartridge
- 1 Red print cartridge
- 2 NiMH rechargeable batteries, 9 V, 300 mAh
- 1 Plug-in power supply, 12 V, 500 mA with split charging cable for 2 inkjet pucks
- 2 Storage boards for inkjet pucks with moistening pads
- 1 Infra-red remote control
- 1 Set of accessories for motion of the edge of an inkjet puck
- 1 Set of accessories for centre of mass motion of two coupled inkjet pucks
- 1 Set of accessories for uniformly accelerated motion (3 single 5 cN weights, pulley, cord)
- 1 Set of accessories for motion on an inclined plane
- 1 Set of accessories for circular motion
- 2 Foam plastic rings for elastic collisions
- 2 Velcro strips for inelastic collisions
- 2 Extra weights, 200 g
- 1 Launching mechanism
- 1 Airtight storage box for print cartridge

P-1021623

Inkjet Pucks Basic Set

Two inkjet pucks with all components required for operation plus accessories for recording motion of edges and centre of mass. Ideal when a suitable air cushion platform is already available.

Contents:

- 2 Inkjet pucks, diameter 100 mm, height 95 mm, weight not including battery and print cartridge 366 g approx.
 - 1 Black print cartridge
 - 1 Red print cartridge
 - 2 NiMH rechargeable batteries, 9 V, 300 mAh
 - 1 Plug-in power supply 12 V, 500 mA with split charging cable for 2 inkjet pucks
 - 2 Storage boards for inkjet pucks with moistening pads
 - 1 Infra-red remote control
 - 1 Set of accessories for motion of the edge of an inkjet puck
 - 1 Set of accessories for centre of mass motion of two coupled inkjet pucks
- P-1021624**



Print Cartridges

Print cartridges compatible with inkjet pucks for recording motion curves on paper.

Contents: 18 ml

Print Cartridge, Black
P-1021628

Print Cartridge, Red
P-1021630



Set of Recording Paper

100 Sheets of DIN A1 printer paper for recording motion curves via inkjets.
Dimensions: approx. 594x841 mm²

P-1021626

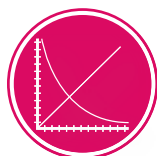

UE1030600
PDF online



Parabolic motion on inclined plane



Sample experiment: Elastic collisions

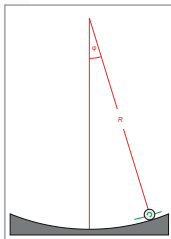

Experiment 1: Investigation of motion and collisions in a single dimension

Equipment:
 P-1002939 Set of 6 Steel Balls
 P-1003039 Optical Bench U, 1200 mm

Marble in a Bowl

Concave transparent acrylic body with spherical curvature. A rolling ball oscillates inside the concavity about its rest position like a mathematical pendulum does. The radius of curvature is equivalent to the length of a normal pendulum. Includes three steel balls.

Diameter of balls: 16 mm
 Radius of curvature: 200 mm
 Diameter: 140 mm

P-1017332

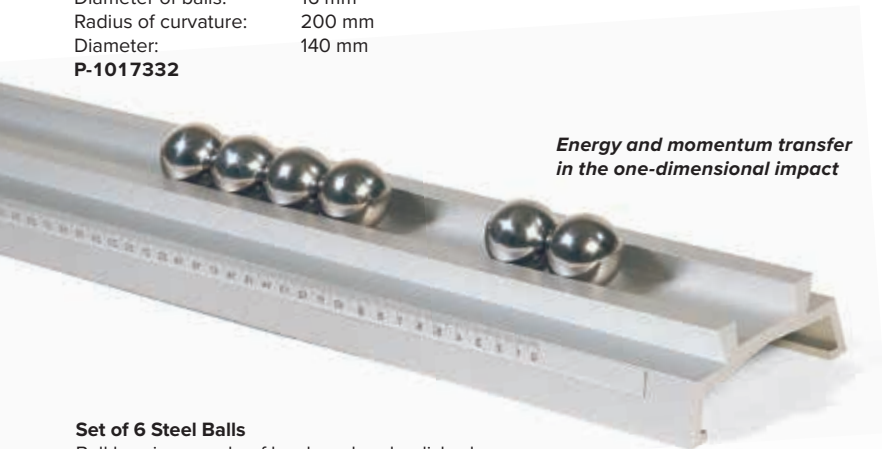

Energy and momentum transfer in the one-dimensional impact

Set of 6 Steel Balls

Ball bearings made of hardened and polished steel. Can be used with a guide rail for experiments on elastic collisions or in combination with watch glasses to demonstrate various states of equilibrium. Rail not included.

Diameter: 30 mm each
 Weight: 110 g each

P-1002939

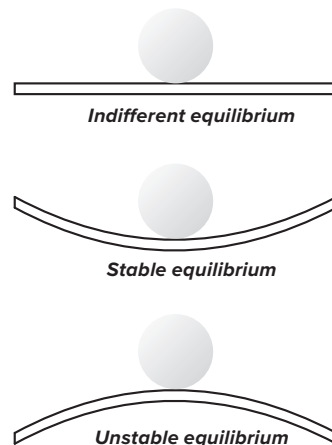

Experiment 2: Stable, unstable and indifferent equilibrium

Equipment:
 P-1002939 Set of 6 Steel Balls
 P-1002868 Set of 10 Watch Glass Dishes, 80 mm
 P-1002869 Set of 10 Watch Glass Dishes, 125 mm
 P-1003190 Plane Mirror

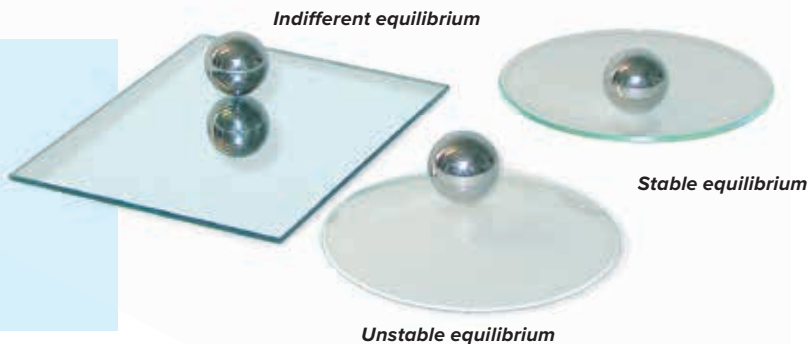

Free Fall and Horizontal Launch Equipment

Equipment for demonstrating the independence of the horizontal and vertical components of motion (for projectiles). A launching rail with returning spring is mounted on a wooden base. Two steel balls are used as test bodies. Upon triggering, one ball starts to fall downwards and simultaneously the other is launched horizontally. Both balls hit the ground at the same time. Two holes in the base plate are provided for storing the balls.

Ball diameter: 15 mm
 Dimensions: approx. 200x120x30 mm³
 Mass: approx. 230 g

P-1000588





Advantages

- Easy to set up
- Precise measurement of time with no systematic errors
- Height of fall can be set to the nearest millimetre
- No searching for lost balls

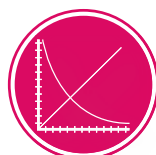
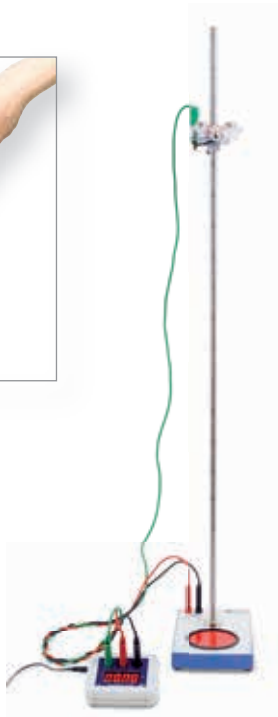

UE1030300
PDF online

Free-Fall Apparatus

Apparatus for measuring the time it takes for a ball to fall a certain distance using a digital timer. Very easy to set up and use but nevertheless highly accurate. Includes 3 steel balls. A micro-magnet holds the ball in its start position. Three contact pins under the release mechanism ensure that the start position of the ball can be reproduced and act as the contacts of a switch that opens when the ball is released, thus triggering the beginning of the timing measurement. When the ball strikes the contact plate at the bottom, the timer is stopped. The ball is also held firmly on the plate so that it does not bounce. The height through which the ball drops can be adjusted to a fraction of a millimetre and read off a scale on the column.

Height scale	20 – 960 mm
Scale divisions:	10 mm
Scale precision:	0.2 mm
Balls:	Steel, 16 mm diam.
Dimensions:	200x130x1000 mm ³
	approx.
Weight:	approx. 1.6 kg

P-1000738

Additionally required:

P-1012832 Millisecond Counter (230 V, 50/60 Hz)

or

P-1012833 Millisecond Counter (115 V, 50/60 Hz)

P-1002848 Set of 3 Safety Experiment Leads for Free-Fall Experiments

P-1018448 Holder for Light Barrier

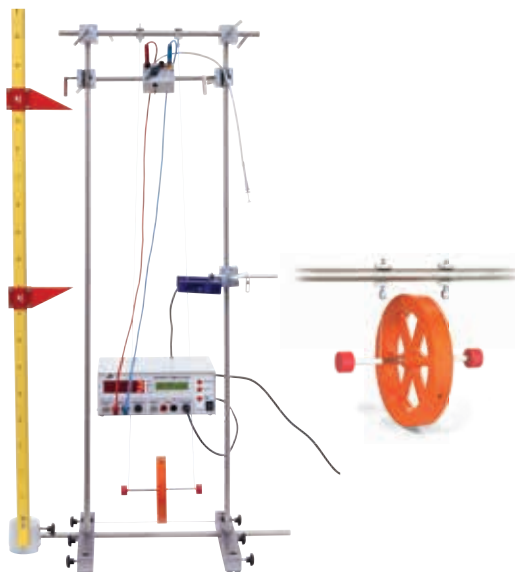

Trigger Device for Maxwell's Wheel

Mechanic start device for triggering a well defined start instant for Maxwell's wheel. With 4-mm sockets for connecting to the start input of the digital counter. Triggering via Bowden cable.

Hole for stand rod: 10 mm diam.
Dimensions: approx. 60x50x50 mm³
Mass: approx. 260 g

P-1018075



Measurement of fall time

Maxwell's Wheel

Spoked wheel with large moment of inertia for demonstrating conservation of energy in the conversion of kinetic energy to potential energy and vice versa. Includes suspending rod and adjustable suspension mechanism. The rotating axle is held in a horizontal position by two strings attached to a suspending rod and is moved upward by winding in the strings. If the equipment is released from its wound in position, the spoked wheel acquires kinetic energy on the way down, which can be seen by the constant increase in its speed of rotation. Two stops on the ends of the axle prevent the wheel from spinning free. At the lowest point when the strings are fully unwound, they start rewinding around the axle and the wheel rises upward again, losing its kinetic energy as it gets higher. To measure the inertial force during acceleration, the whole apparatus complete with stand is placed on a set of scales.

Moment of inertia:	10 kg cm ² approx.
Diameter of wheel:	130 mm approx.
Mass of wheel:	370 g approx.
Suspending rod:	370 mm x 12 mm diam.

P-1000790

Additionally recommended:

P-1002936 Stainless Steel Rod 1000 mm (2x)

P-1018874 Stand with H-Shaped Base

P-1002830 Universal Clamp (4x)

P-1012848 Stainless Steel Rod 280 mm

P-1018075 Trigger Device for Maxwell's Wheel

P-1000563 Photo Gate (2x)

P-1001033 Digital Counter/Timer (230 V, 50/60 Hz)

or

P-1001032 Digital Counter/Timer (115 V, 50/60 Hz)

Free-Fall Tube

(Guinea and Feather Apparatus)

This glass tube can be evacuated to compare the free falling characteristics of different objects in a vacuum. Duck feathers and plastic parts are included as falling objects.

Length glass tube:	approx. 750 mm
Diameter:	36 mm
Hose nipple:	10 mm
Weight:	approx. 1 kg

P-1000801

Additionally required:

P-1012855 Rotary-Vane Vacuum Pump, One-Stage

P-1002619 Vacuum Hose, 8 mm

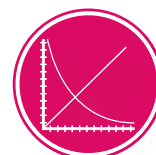

UE1040320
PDF online

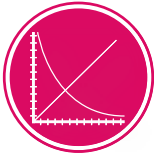

UE1030400
PDF online



Advantages

- Three reproducible launch speeds
- Continuous adjustment of launch angle
- Constant height of trajectory, independent of angle setting
- Balls launched with no rotational spin

Projectile Launcher

Experimental equipment for the quantitative investigation of projectile laws: vertical horizontal and angled launch, recording of flight trajectories depending on launch angle and projectile range. Three different reproducible launch speeds, continuously adjustable launch angles, constant height of trajectory at various angles since the launch point is coincident with pivot point of the cannon. Projectile is launched with almost no spin. The encapsulated design and the use of spherical plastic projectiles ensure that experiments are safe. The launcher is attached to a table via clamp (P-1002655) or can be used in conjunction with ballistic pendulum (P-1002656).

Horizontal projectile range (Launch angle 45°): 1.1 m, 2.3 m and 4.5 m
 Launch angle: 0° – 90°
 Reproducibility at 45°: standard deviation less than 1%
 Standard deviation of launch ranges: < 1%
 Diameter of projectiles: 25 mm
 Mass of projectiles: 7 g
 Dimensions: approx. 205x65x60 mm³
 Mass: approx. 480 g

Contents:

- 1 Launcher
- 3 Plastic projectile balls
- 1 Ramrod
- 1 Wing nut M8x20

P-1002654

Additionally required:

P-1002655 Clamp for Projectile Launcher

or

P-1002656 Ballistic Pendulum

Protective Goggles

Additionally recommended:

P-1002657 Photo Gate Holder for Projectile Launcher

P-1000563 Photo Gate

Experiment Topics:

- Vertical, angled and horizontal launch
- Recording of the trajectory with an angled launch
- Determination of range and height from the projection angle
- Determination of launch speed from the range and height
- Determination of launch speed using a ballistic pendulum
- Elastic and inelastic collisions

Clamp for Projectile Launcher

Table clamp for Projectile Launcher (P-1002654) made of anodized aluminium.

Span: 10 mm – 65 mm
 Dimensions: approx. 150x70x80 mm³
 Mass: approx. 710 g

P-1002655

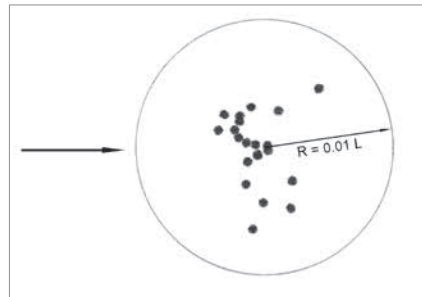

Typical results for measurement of 20 shots. L = range.

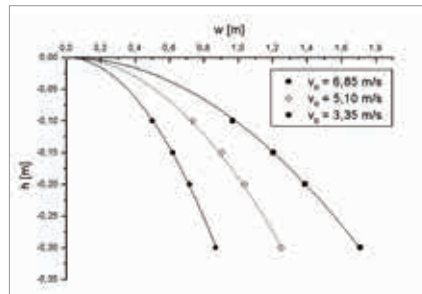

Horizontal launch: projectile height as a function of the projectile distance

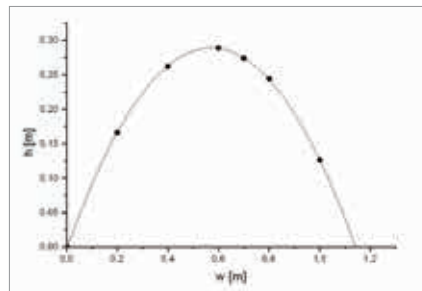

Oblique launch: projectile height as a function of the projectile distance (launch angle: 45°)

Ballistic Pendulum

Accessories for the (P-1002654) launcher for use in experiments on elastic and inelastic collision or to be used as a holder for experiments on trajectory. The speed of the balls as measured in launcher experiments or pendulum experiments agree to within approximately $\pm 3\%$. Additional weights can be used to investigate how pendulums behave with differing angles of deflection at the same speed. For experiments investigating trajectories, the launcher can be set to 5 different launch heights 5, 10, 15, 20 and 30 cm when it is attached to the rear of the ballistic pendulum.

Height of pendulum: 370 mm
 Extra weights: 17.5 g each
 Base plate: approx. 130x130 mm²
 Span of bench clamp: 10 – 65 mm
 Mass: approx. 2.1 kg

Contents:

- 1 Ballistic pendulum with table clamp
- 2 Extra weights

P-1002656

Additionally required:

P-1002654 Projectile Launcher



Photo Gate Holder for Projectile Launcher

Holder for mounting the photo gate (P-1000563) at the exit of the projectile launcher (P-1002654).

P-1002657

Set of 3 Steel Balls (not shown)

Spare balls for the free fall apparatus (P-1000738), launcher S (P-1000740) and marble in a bowl (P-1017332).

Diameter: 16 mm

P-4003748

Launcher S

Experimental apparatus for studying vertical and horizontal trajectories as well as trajectories starting at intermediate angles. Also demonstrates the independence of the horizontal and vertical components of motion (for projectiles). Provides for three different launch velocities. Angle of launch can be adjusted to any arbitrary angle and read off from a protractor scale with a plumb line. The projectile ball is held in place by a magnet until the moment of launch so that the height of the trajectory is independent of the launch angle. When a projectile is launched, a second ball can be released simultaneously from the other side of the launcher that then descends in free fall. The latter should strike the floor at the same time as the projectile if the launch angle is horizontal.

Launch angle: $0^\circ - 90^\circ$
 Maximum range: 4 m
 Projectile diameter: 16 mm
 Projectile weight: 17 g
 Diameter: approx. 280x90x90 mm³
 Total weight: approx. 950 g

P-1000740

Additionally required:

P-1002934 Stainless steel rods, 470 mm (2x)

P-1002832 Table clamps (2x)

Protective goggles



Experiment Topics:

- Rotational motion: uniform and under constant acceleration
- Newton's equations of motion for rotational motion
- Moment of inertia and torque
- Moment of inertia as determined by experiment
- Simple harmonic motion of rotating objects



Rotating System on Air Bed

Apparatus for investigating frictionless rotation. A small rotating disc with a protractor scale supports a cross bar to which weights can be attached. The disc is supported by a bed of air in which its axis is centred. A driving weight is suspended from a hook at the end of a string that is passed over a single pulley on one side and a multiple pulley on the other. The rotation is very slow and can be measured using a stopwatch by hand. Alternatively, a digital timer may be used. This can be started by a mechanism that is supplied with the kit and halted by a signal from a laser reflection sensor when the wheel passes through angle zero.

Protractor scale:	0 – 360°
Scale divisions:	1°
Length of cross bar:	ca. 440 mm
Radii of perforations:	30 – 210 mm
Separation of perforations:	20 mm
Radii of multiple pulley:	5.0 mm/10.0 mm/15.0 mm
Moment of inertia of disc with cross bar:	approx. 0.9 g m ²
Maximum moment of inertia:	approx. 71 g m ²
Minimum driving torque:	approx. 0.05 mN m
Maximum driving torque:	approx. 0.60 mN m

Contents:

- 1 Air bed
- 1 Rotating disc with cross bar
- 1 Multiple pulley
- 1 Release mechanism
- 2 S-shaped hooks 1.00g
- 1 S-shaped hook 2.00 g
- 1 Set of weights (2x 12.5 g, 2x 25 g, 2x 50 g)
- 1 Compressor for connection to mains
- 1 Silicon tubing with by-pass valve (not illustrated)
- 1 Pulley
- 1 Stand rod with 3 securing screws and 2 screws for levelling
- 1 Stand rod with 2 securing screws
- 1 Stand rod, 250 mm
- 1 Levelling disc
- 1 Roll of thread

Rotating System on Air Bed (230 V, 50/60 Hz) P-1000782

Rotating System on Air Bed (115 V, 50/60 Hz) P-1000781

Additionally recommended:

- P-1001034 Laser Reflection Sensor
- P-1001033 Digital Counter/Timer (230 V, 50/60 Hz)
- or
- P-1001032 Digital Counter/Timer (115 V, 50/60 Hz)
- P-1000783 Supplementary Kit for Rotating System on Air Bed

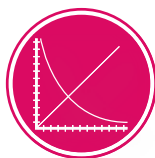

UE1040101

PDF online

Supplementary Kit for Rotating System on Air Bed

Supplementary kit for the rotating system on air bed (P-1000782/ P-1000781) for investigating frictionless rotational motion and oscillations using a large rotating disc. On the underside of the large disc is an angle grid that can be used to provide triggers to a laser reflection sensor (P-1001034) if the rotation is to be recorded with the help of the VinciLab interface unit.

Typical oscillation periods: approx. 20 s to approx. 2 mins
Moment of inertia of large disc: approx. 2.2 g m²

Contents:

- 1 Large disc with protractor scale, 350 mm
 - 1 Scaffold stand
 - 1 Cross sleeve
 - 1 Set of coupling springs with magnet (1 N, 2 N, 5 N)
- P-1000783**

Additionally recommended:

- P-1001034 Laser Reflection Sensor
- and
- P-1001033 Digital Counter (230 V, 50/60 Hz)
- or
- P-1001032 Digital Counter (115 V, 50/60 Hz)
- or
- P-1021477 VinciLab
- Software Coach 7

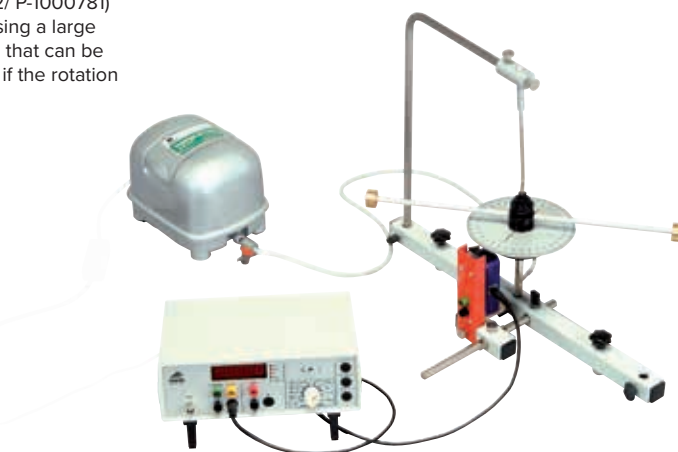

Measuring the period of oscillation and determining the moment of inertia



Watt's Governor

Symmetrical pendulum system on an axle, for demonstrating centrifugal force. The pendulum arms are held in a state of rest by a coil spring. Depending on the rotational speed, they are lifted against the force of gravity as the axle turns. This can then be used to control the speed of a steam engine.

Rotation diameter: approx. 350 mm
 Height: approx. 250 mm
 Diameter of axle: 10 mm

P-1009695

Additionally required:

P-1021806 Experiment Motor with Gearbox

P-1002832 Table Clamp

P-1003312 DC Power Supply 0 – 20 V, 5 A (230 V, 50/60 Hz)

or

P-1003311 DC Power Supply 0 – 20 V, 5 A (115 V, 50/60 Hz)

Additionally recommended:

P-1003331 Digital Stroboscope (230 V, 50/60 Hz)



Rotation Apparatus

Rotating apparatus for determining angular acceleration as a function of the torque and for determining the moment of inertia depending on mass and distance from an axis. An axle on agate bearings supports a cross bar to which weights can be attached. The force from a driving weight is conveyed to the axle via a string wrapped around the axle and passed over a pulley and a second multiple pulley on the axle itself.

Length of crossbar: 600 mm
 Radii of multiple pulley: 4.5 mm / 9.0 mm
 Driving weights: 10 g / 20 g / 30 g / 40 g / 50g
 Inertial mass of disc(s): 100 g / 200 g / 300 g
 Dimensions of base plate: approx. 200x140 mm²
 Total weight: approx. 1.3 kg

Contents:

1 Basic apparatus	2 Slotted weights 10 g
2 100-g discs	1 Slotted weight 20 g
2 200-g discs	1 Pulley
1 Holder for slotted weights 10 g	1 Roll of string

P-1006785

Additionally recommended:

P-1003331 Digital Stroboscope (230 V, 50/60 Hz)

Experiment Motor with Gearbox

Experiment motor for universal use in experiments on rotational motion, e.g. for experiments using the Watt's governor (P-1009695). Can also be used as a generator in conjunction with the included hand crank. Robust clockwise and counter-clockwise rotating IDC motor with epicyclic gearbox and quick-action chuck in a tough anodized aluminum casing with removable and adjustable stainless steel stand rod. Speed of rotation is adjusted by altering the supply voltage. Adjustable torque. Includes 3 belt pulleys of different diameters on a mounting axle.

Speed without load: approx. 650 rpm at 18 V
 Speed sensitivity: approx. 36 rpm per V
 Span of chuck: 0.8 to 10 mm
 Pulleys: 10 mm diam., 20 mm diam., 40 mm diam.
 Axle: 10 mm diam.
 Drive belt: 130 mm diam. x 4 mm
 Nominal voltage: 1.5 - 18 V DC
 Connection: via 4-mm safety sockets
 Dimensions: approx. 210x110x70 mm³
 Mass: approx. 1.2 kg

P-1021806

Contents:

Experiment motor
 Stand rod with knurled screws
 Hand crank
 Pulleys
 Drive belt



Additionally required:

P-1003312 DC Power Supply 0 – 20 V, 5 A (230 V, 50/60 Hz)

or

P-1003311 DC Power Supply 0 – 20 V, 5 A (115 V, 50/60 Hz)

Experiment Topics:

- Moment of inertia of a disc
- Torque
- Angular momentum
- Precession
- Nutation



Gyroscope

High quality precision made gyroscope for demonstration as well as for quantitative determination of gyroscopic laws by means of practical experiments. Experiment apparatus with a shaft that can be tilted and rotated while attached to a stand rod. On one side of the shaft there is a disc mounted on dual ball bearings, while on the opposite side there is a movable counterweight for establishing equilibrium. Fine adjustment is performed by thumb screw at the end of the shaft. To generate external torque an additional weight is provided that can also be moved along the shaft. The shaft's angle of inclination can be read from an easily readable scale. A spirit level allows the gyroscope to be adjusted to the horizontal. The disc can be set rotating by hand or by means of a cord. The dual ball bearing system ensures that rotation is nearly frictionless and that rotation continues for lengthy periods of time. The open construction of the gyroscope allows gyroscopic phenomena to be observed easily and clearly.

- Scale: - 40° to + 40°
- Scale divisions: 1°
- Disc: 250 mm dia.
- Mass of disc: 1500 g
- Mass of counterweight: 400 g
- Mass of additional weight: 50 g
- Total weight: approx. 4650 g

P-1000695

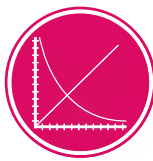

UE1040500
PDF online

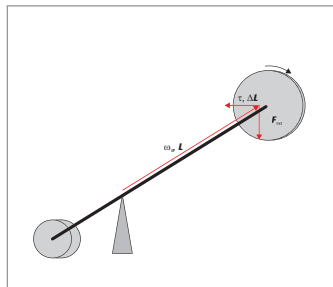

Schematic of a gyroscope illustrating precession

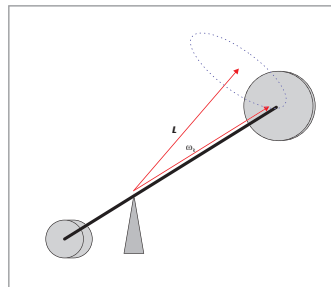

Schematic of a gyroscope illustrating nutation

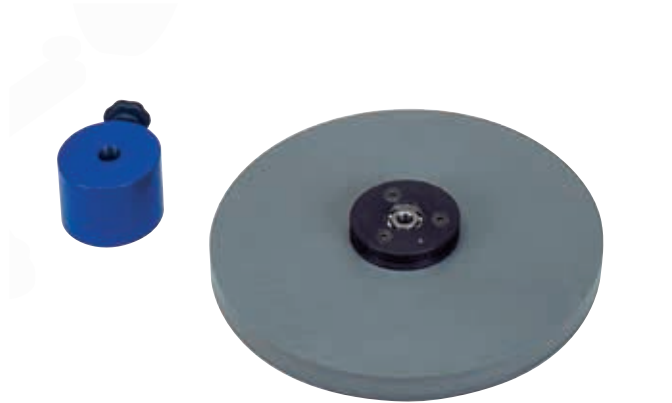

Gyroscope Accessories

Accessories kit for Gyroscope (P-1000695) consisting of a gyroscope disc and counterweight. For demonstrating the canceling out of gyroscopic phenomena in the case of two discs rotating at the same speed in opposite directions.

P-1000698



Gyroscope S

Gyroscope with low-profile, dynamically balanced metal rotor in a Cardan gimbal mount. Ideal for studying gyroscopic stability phenomena, precession and nutation. Also supplied is a pendulum mounting that can be used for investigating the rolling or tipping moment. The set includes plastic Cardan discs, Cardan gimbal mount, pendulum mounting and starting cord.

Dimensions: approx. 170x120 mm²

P-1013228



Advantages

- Low-friction needle bearing
- Electromagnetic angle sensor

Pendulum Rod with Angle Sensor

Pendulum with low-friction pointed bearings and electromagnetic angle sensor for measuring simple harmonic motion of a weighted pendulum with movable weight. Including plug-in power supply. The deflection of the pendulum is detected by a Hall sensor that converts the angle to an electrical signal proportional to the angle so that the oscillation can be recorded using an interface unit, a Y-t plotter or a storage oscilloscope.

Length of pendulum:	1 m
Mass of pendulum:	approx. 1 kg
Output voltage:	± 5 V
Output resistance:	500 Ω
Power supply:	12 – 16 V AC
Diameter of tube:	10 mm
Weight:	approx. 1,4 kg

Pendulum Rod with Angle Sensor (230 V, 50/60 Hz) P-1000763

Pendulum Rod with Angle Sensor (115 V, 50/60 Hz) P-1000762

Additionally required:

- P-1002832 Table clamp
- P-1002936 Stainless steel rod, 1000 mm
- P-1002830 Universal clamp

Additionally recommended:

- P-1002750 Adaptor, BNC Plug/4 mm Jacks
- P-1021680 Voltage Sensor 10 V, Differential
- P-1021478 €Lab
- Software Coach 7



Set of 4 Pendulum Bobs

4 balls with securing eyes: made of brass, aluminium, steel and plastic for constructing a mathematical pendulum.

Diameter:	25 mm
Weights:	71.2 g, 25.2 g, 61 g, 10.5 g

P-1003230

Additionally required:

- P-1001055 Experiment Cord
- Stand Equipment

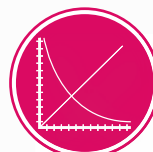
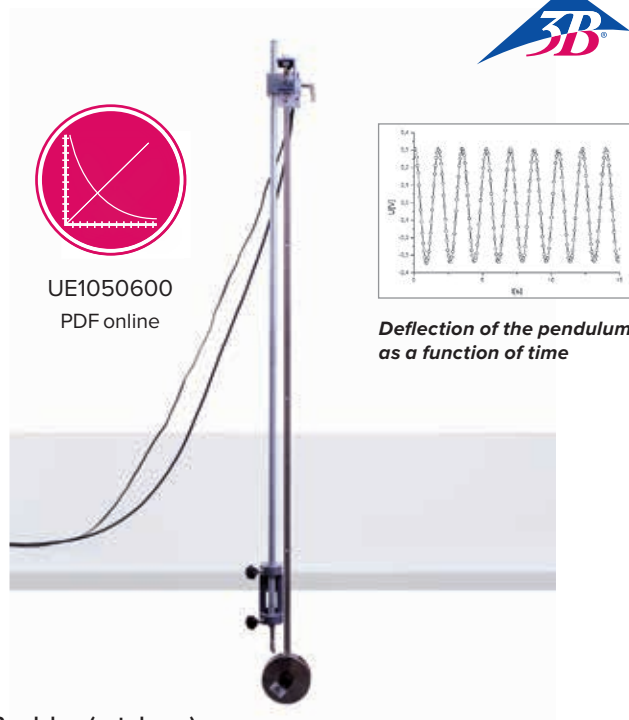

UE1050600
PDF online

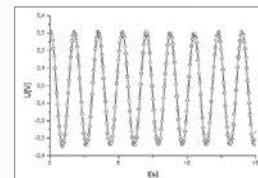

Deflection of the pendulum as a function of time

Rod Pendulum (not shown)

Rod pendulum with low-friction pointed bearings as per P-1000763 or P-1000762 but with no Hall sensor or magnet for detecting angle.

P-1000764

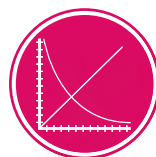

UE1050101
PDF online

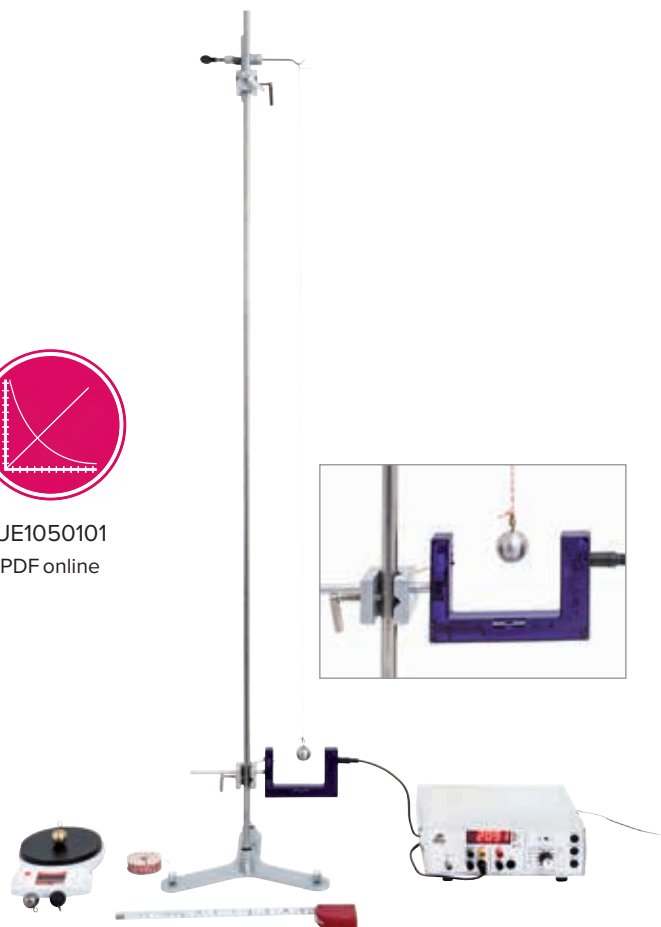

Variable g Pendulum

Pendulum with continuously adjustable plane of oscillation for observing pendulum oscillations where the acceleration due to gravity g can appear to be varied.

Max. length of pendulum: 280 mm
Mass of pendulum: 0.5 kg
Angle of plane of oscillation: $0^\circ - 90^\circ$
Dimensions: approx. 300x250x550 mm³
Mass: approx. 5 kg

P-1000755

Additionally required:

P-1002836 Stand Base, Tripod, 185 mm

P-1002934 Stainless Steel Rod, 470 mm

Additionally recommended:

P-1000756 Photogate Holder for Pendulum

P-1000563 Photo Gate

P-1001033 Digital Counter (230 V, 50/60 Hz)

or

P-1001032 Digital Counter (115 V, 50/60 Hz)



Chaotic Pendulum E

A double pendulum made of anodised aluminium for mounting on a rigid wall. Both lengths of the pendulum are manufactured with the utmost precision and rotate, or oscillate, without friction around their axis. The way the movement develops is unpredictable and therefore chaotic. Depending on the initial conditions, the pendulum lengths begin rotate and lose energy due to friction. Once the energy is no longer sufficient, the rotation gives way to oscillation. The motion of each of the pendulums is affected by the other. This means that the rotation of the second length can be transferred to the first, which may provide it with enough energy to rotate again. The chaotic pendulum stops when all the energy has been lost due to friction.

Dimensions: 350x38x52 mm³

P-1017531

P-1000755

P-1000756

P-1002934

P-1002836



Photogate Holder for Pendulum

Holder for mounting the light barrier (P-1000563) with a variable-g pendulum, for which the plane of oscillation can be set at any angle.

P-1000756

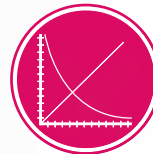

UE1050201

PDF online

P-1001033

P-1001032



Experiment Topics:

- Harmonic oscillations
- Determining unknown masses
- Gravitational mass and inertial mass



Inertia Balance

Inertia balance for determining inertial mass. After the apparatus is calibrated by determining the vibration frequency for objects of known mass, it can be used to determine the unknown masses. The Inertia Balance consists of two metal trays connected by stiff steel spring strips. One tray has 3 holes to hold up to three masses and the other tray may be anchored to a table edge or laboratory bench with the included table clamp.

Length of steel strip: approx. 350 mm
Masses: approx. 175 g each

Contents:

- 1 Inertia Balance
- 1 Table clamp
- 1 Cord, 1.85 m
- 3 Masses

P-1003235

Additionally required:

P-1003369 Mechanical Stopwatch, 15 min

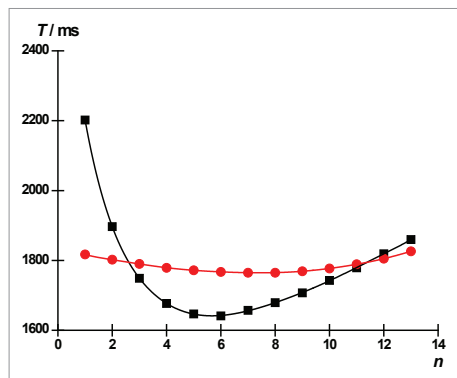

Periods of oscillation around both fulcra as a function of the position of the sliding weight

Experiment Topics:

- Measurement of periods of oscillation of Kater's reversible pendulum for two fulcra
- Adjustment of Kater's reversible pendulum for equal periods of oscillation
- Determination of acceleration due to gravity

Kater's Reversible Pendulum

Special form of physical pendulum for determining local acceleration due to gravity g . Pendulum rod with two fulcra plus one sliding and one fixed disc weight for adjusting the period of oscillation. When correctly adjusted, the pendulum will oscillate about both fulcra with the same period of oscillation. The pendulum rod exhibits particularly low friction and is suspended in a stable frame. In order to adjust orientation, the support is equipped with two adjustment screws and a spirit level. Includes mounting plate for light barrier.

Height of apparatus with pendulum: approx. 1.25 m
Length of pendulum rod: 1.2 m
Separation of bearing points: 800 mm
Period of adjusted pendulum: 1794 ms when $g = 9.81 \text{ m/s}^2$
Total weight: approx. 6.3 kg

P-1018466

Additionally required:

- P-1000563 Light Barrier**
 - P-1001033 Digital Counter (230 V, 50/60 Hz)**
- or
- P-1001032 Digital Counter (115 V, 50/60 Hz)**



Mechanical Oscillations in a Space-Saving Tabletop Experiment

Sensors “Mechanical Oscillations”

Set incorporating two dynamometers and an amplifier board for recording and analysing mechanical oscillations using a standard oscilloscope. The dynamometers can be fitted to 10-mm diameter stands or the SW tie bar in order to measure dynamic forces along their axes. The amplifier board converts signals from both dynamometers so that they can be recorded and also evaluates the phase differences between both oscillation signals, outputting them as a DC signal. If the MEC amplifier board is connected to the 2x25 MHz PC oscilloscope (P-1020857), it is possible to perform detailed analysis and evaluation of measured signals using the oscilloscope software on a PC.

Dynamometers:

Maximum force: 5 N
 Frequency range: 0.3 – 200 Hz
 Connectors: 3.5-mm jack plugs
 Dimensions: approx. 52x37x26 mm³

MEC amplifier board:

Input sockets: 3.5-mm jack sockets
 Output sockets: BNC
 Dimensions: approx. 65x100x40 mm³

Contents:

2 Dynamometers
 1 MEC amplifier board
 1 Power supply, 12 V AC, 700 mA
 2 HF Patch cords

Sensors “Mechanical Oscillations” (230 V, 50/60 Hz)
P-1012850

Sensors “Mechanical Oscillations” (115 V, 50/60 Hz)
P-1012851

Additionally recommended:

P-1020857 PC Oscilloscope, 2x25 MHz

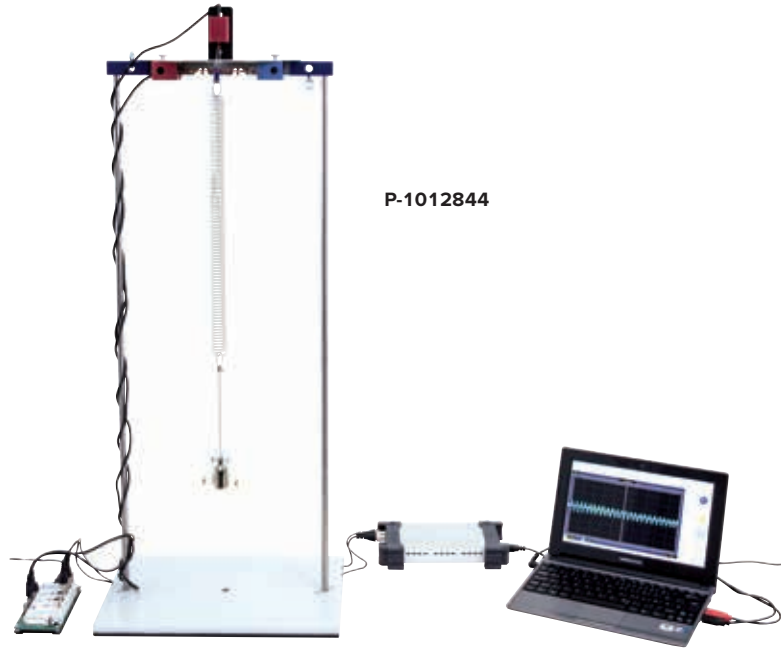

Supplementary Kit “Wilberforce Pendulum”

Set for building a Wilberforce pendulum or a torsion pendulum in a space-saving table-top experiment. Adjustable rotating body for fine adjustment of moment of inertia in order to investigate couples translation and rotation oscillations as per Wilberforce’s experiment. Includes components for connecting to dynamometers from Sensors “Mechanical Oscillations” (P-1012850 or P-1012851) in order to record and comprehensively analyse oscillations using a standard oscilloscope.

Contents:

1 Spring, 5 N/m
 1 Rotating body
 1 Vertical plate
 1 Body with hook
 1 Spring set B for fitting to dynamometer
P-1012844

Additionally required:

P-1012849 Stand Equipment “Mechanical Oscillations”

Additionally recommended:

P-1012850 Sensors “Mechanical Oscillations” (230 V, 50/60 Hz)
 or
P-1012851 Sensors “Mechanical Oscillations” (115 V, 50/60 Hz)
P-1020857 PC Oscilloscope, 2x25 MHz



P-1012850
 P-1012851

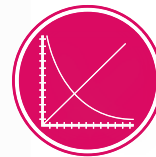

UE1050121
PDF online

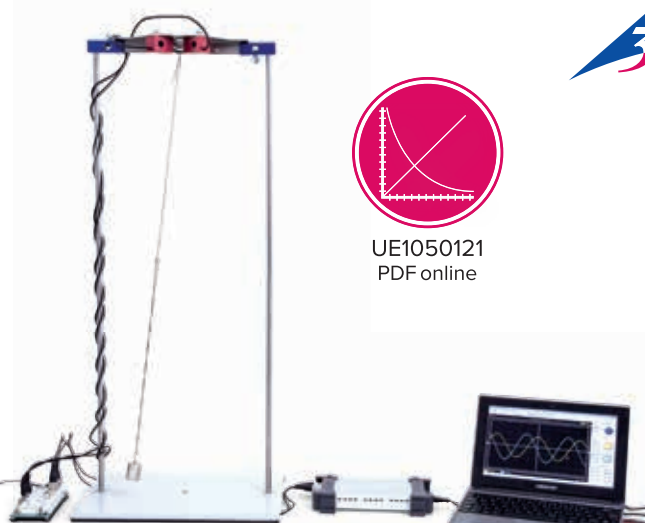
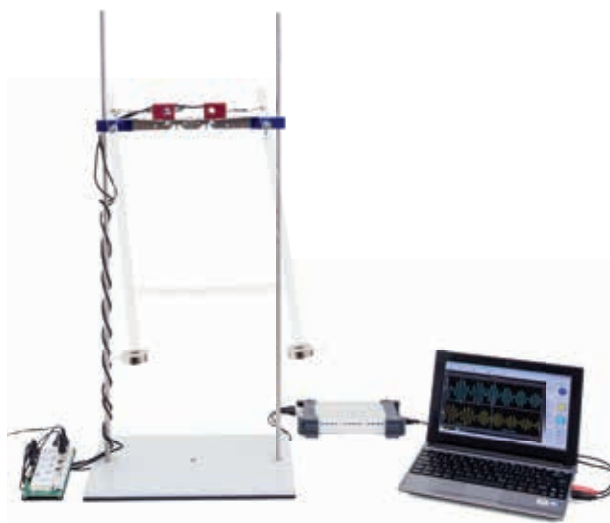

Supplementary Kit “Physical Pendulum”

Versatile set for building a physical pendulum with a moveable weight, a reversing pendulum or a pair of coupled pendulums in a space-saving table-top experiment. Includes components for connecting to dynamometers from Sensors “Mechanical Oscillations” (P-1012850 or P-1012851) in order to record and comprehensively analyse oscillations using a standard oscilloscope.

Contents:

- 2 Bearing bars
- 2 Pendulum rods
- 2 Weights, 200 g
- 1 Weight, 150 g
- 1 Acrylic ring
- 1 Spring, 2.5 N/m
- 2 Coupling spring sets C

P-1012853

Additionally required:

P-1012849 Stand Equipment “Mechanical Oscillations”

Additionally recommended:

P-1012850 Sensors “Mechanical Oscillations” (230 V, 50/60 Hz)

or

P-1012851 Sensors “Mechanical Oscillations” (115 V, 50/60 Hz)

P-1020857 PC Oscilloscope, 2x25 MHz

Supplementary Kit “String Pendulum”

Kit for easy assembly of a string pendulum for comprehensive investigation of simple harmonic motion and chaotic oscillations in a space-saving table-top experiment. Features movable string pulley for setting string lengths and magnetic strips for generating chaotic oscillations. Other components are for connecting to dynamometers from Sensors “Mechanical Oscillations” (P-1012850 or P-1012851) in order to record and analyse oscillations with two degrees of freedom using a standard oscilloscope.

Contents:

- 1 String, 100 m
- 1 Weight, 100 g
- 1 Long magnetic strip
- 2 Short magnetic strips
- 1 Spring set A for fitting to dynamometer

P-1012854

Additionally required:

P-1012849 Stand Equipment “Mechanical Oscillations”

Additionally recommended:

P-1012850 Sensors “Mechanical Oscillations” (230 V, 50/60 Hz)

or

P-1012851 Sensors “Mechanical Oscillations” (115 V, 50/60 Hz)

P-1020857 PC Oscilloscope, 2x25 MHz

Stand Equipment “Mechanical Oscillations”

Stand equipment for easy, understandable and stable assemblies, e.g. for investigating mechanical oscillations and waves using the sensors from Sensors “Mechanical Oscillations” (P-1012850 or P-1012851). Including SW base plate as non-tilting base to accommodate the stand rods, two double clamps and SW tie bar. The SW tie bar serves as multi-function holder for fitting between stand rods on the base plate in order to build set-ups featuring the dynamic force sensors from Sensors “Mechanical Oscillations”.

Base plate: approx. 345x240x16 mm³

Stand rods: approx. 400 mm x 10 mm diam.

Contents:

- 1 SW Base plate
- 2 Stand rods with internal and external thread
- 2 Stand rods with external thread
- 2 SW Double clamps
- 1 SW Tie bar

P-1012849

Additionally recommended:

P-1012848 Steel Rod 280 mm

P-1012847 Steel Rod 400 mm

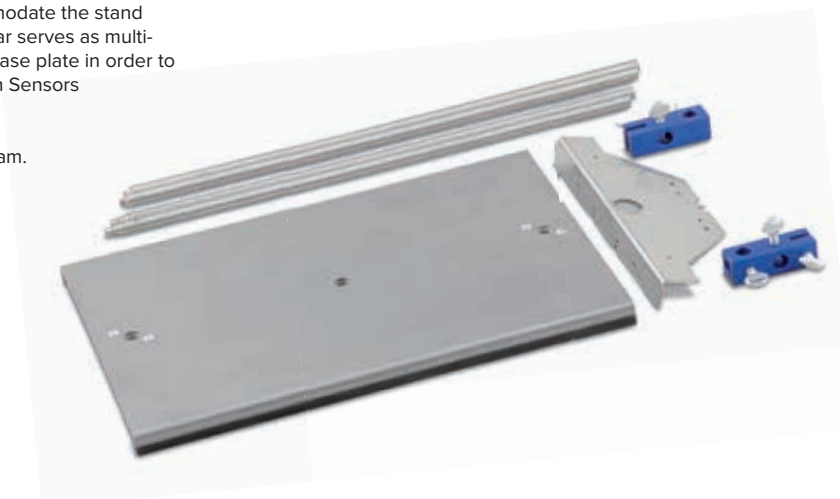



Experiment Topics:

- Pendulum oscillations
- Rotation of the Earth
- Coriolis force

Foucault Pendulum

Pendulum for qualitative and quantitative demonstration of the rotation of the earth by means of observing the plane of oscillation. To prevent the oscillation taking an elliptical path, the thread upon which the pendulum bob is suspended passes through a Charron ring. The plane of the oscillation is detected with high accuracy by projecting the shadow of the thread onto a protractor scale. The rotation of the plane can thus be identified in a very short period of time. For longer periods of observation, the gradual damping of the oscillation can be compensated for by means of an electromagnetic boost that can be adjusted to an arbitrary value. The apparatus is presented in decorative fashion inside a box with all sides made of and lit from the inside to make for a very eye-catching appearance.

Length of pendulum: 1200 mm
 Mass of pendulum: 230 g
 Diameter: 38 mm
 Vertical alignment: By means of four height-adjustable feet
 Angular resolution: 0.1°
 Dimensions: approx. 400x400x1400 mm³
 Mass: approx. 40 kg

**Foucault Pendulum (230 V, 50/60 Hz)
 P-1000748**

**Foucault Pendulum (115 V, 50/60 Hz)
 P-1000747**

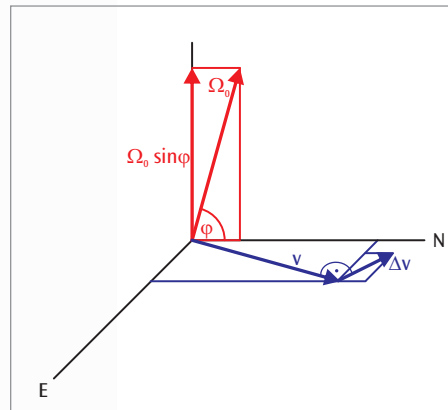
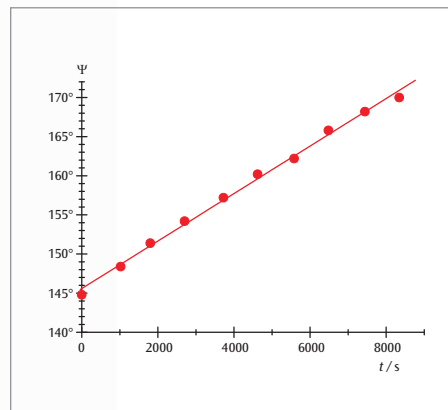
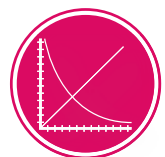

Illustration of Foucault pendulum in fixed earth-based coordinate system.



Measured curve recorded at latitude $\psi = 50^\circ$



UE1050250
 PDF online

Experiment Topics:

- Free rotary oscillations at various degrees of damping (oscillations with moderate damping, aperiodic oscillations and aperiodic borderline case)
- Forced oscillations and their resonance curves at various degrees of damping
- Phase displacement between the exciter and resonator during resonance
- Chaotic rotary oscillations

Plug-in Power Supply 24 V, 0.7 A

Plug-in power supply for the electric motor used with Pohl's pendulum (P-1002956). Including cables and two safety plugs on the secondary side.

Output voltage: 24 V, 0.7 A

Length of cables: 1 m

Plug-in Power Supply 24 V, 0.7 A (230 V, 50/60 Hz)

P-1000681

Plug-in Power Supply 24 V, 0.7 A (115V, 50/60 Hz)

P-1000680

Pohl's Torsion Pendulum

For investigating free, forced and chaotic oscillations at various degrees of damping. With slotted scale ring and pointers on resonator and exciter. An electric motor is included for exciting forced oscillations. It features coarse and fine speed adjustment and is coupled via an eccentric wheel. For damping, an electromagnetic eddy brake is used. The equipment can also be used in demonstrations involving projection of shadows.

Natural frequency:	approx. 0.5 Hz
Excitation frequency:	0 to 1.3 Hz
Connectors:	4-mm safety sockets
Motor:	max. 24 V AC/DC, 0.7 A
Eddy brake:	0 – 2 A DC, 20 V
Scale ring:	300 mm diam.
Dimensions:	approx. 400x140x270 mm ³
Weight:	approx. 4 kg

P-1002956

Additionally required:

P-1003312 DC Power Supply 0 – 20 V, 0 – 5 A (230 V, 50/60 Hz)

P-1000681 Plug-in Power Supply 24 V, 0.7 A (230 V, 50/60 Hz)

or

P-1003311 DC Power Supply 0 – 20 V, 0 – 5 A (115 V, 50/60 Hz)

P-1000680 Plug-in Power Supply 24 V, 0.7 A (115 V, 50/60 Hz)

P-1003369 Stopwatch, 15 min

P-1013526 Analogue Multimeter Escola 30

Patch Cords

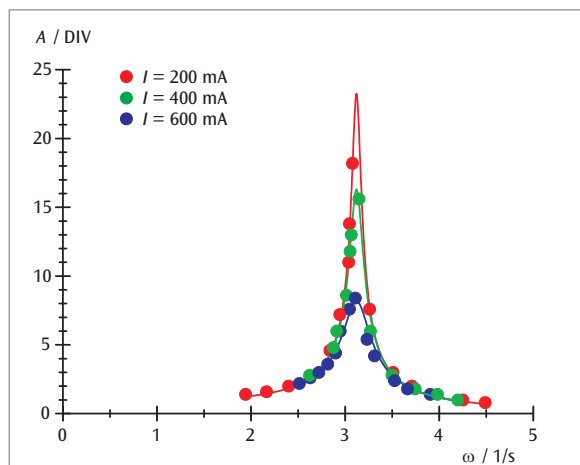

Resonance curve for different degrees of damping



UE1050550
PDF online

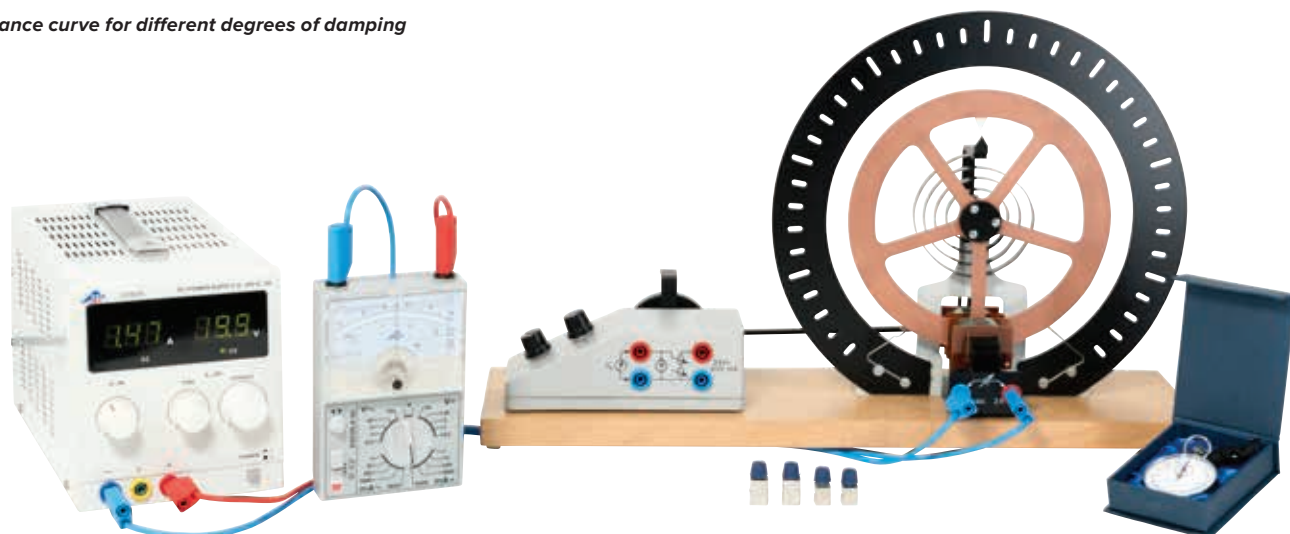

Experiment Topics:

- Rotary oscillations
- Determination of moments of inertia using the oscillation method
- Moments of inertia of various geometric bodies
- Steiner's theorem

Torsion Axle

Robust axle for investigating rotational oscillation of various test bodies and for determining their moments of inertia from the period of oscillation. With ball-bearing mounted shaft, high-quality coil spring and holding lug. Tests are undertaken on weights, which can be moved along a thin transverse rod. A circular disc, which can be used for determining moments of inertia for eccentric axes of rotation and confirming Steiner's theorem is included.

Deflecting torque of the spring: 0.028 Nm/rad.
 Height of the torsional axle: approx. 200 mm

Transverse rod:

Length: 620 mm
 Weight: 135 g
 Weights: 260 g each

Disc:

Diameter: 320 mm
 Weight: 495 g
 Boreholes: 8
 Borehole spacing: 20 mm

P-1008662

Additionally required:

P-1002836 Stand Base Tripod, 185 mm

Additionally recommended:

P-1002811 Digital Stopwatch

P-1003104 Precision Dynamometer 1 N

P-1008663 Set of Test Bodies for Torsion Axle



Moment of inertia J of weights as a function of their radius r from the axis of rotation

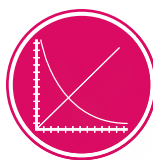

UE1040205

PDF online

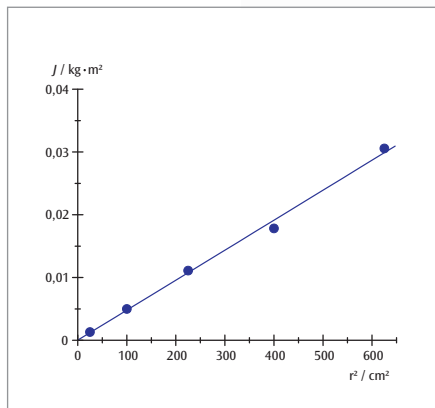
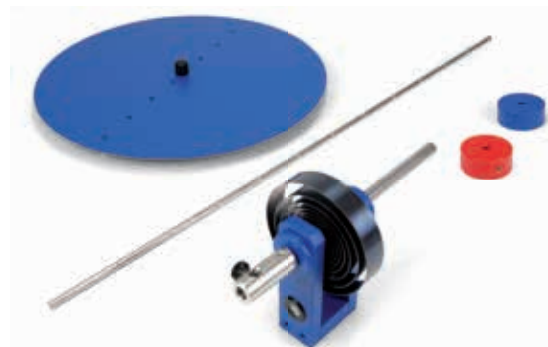

P-1008663



Set of Test Bodies for Torsion Axle

Accessories for the torsion axle (P-1008662) used to demonstrate how moment of inertia depends on the distribution of weight around the axis of rotation. Consisting of two cylinders with nearly identical weights but different weight distributions, a mounting plate for the cylinders, a wooden disc and a wooden sphere.

P-1008663

Hollow cylinder (metal):

External diameter: 90 mm
 Height: 90 mm
 Weight: approx. 425 g

Solid cylinder (wood):

Diameter: 90 mm
 Height: 90 mm
 Weight: approx. 425 g

Mounting plate:

Diameter: 100 mm
 Weight: approx. 122 g

Wooden disc:

Diameter: 220 mm
 Height: 15 mm
 Weight: approx. 425 g
 Moment of inertia: 0.51 kgm²

Wooden sphere:

Diameter: 146 mm
 Weight: approx. 1190 g
 Moment of inertia: 0.51 kgm²



Archimedes' Beaker

Beaker with stirrup and hook including snug-fitting cylinder with eyelet for the verification of Archimedes' principle.

Diameter: 30 mm
Height: 78 mm

P-1021647

Additionally recommended:

P-1021824 Beam Balance with Metal Bridge



P-11021824

For demonstrating Archimedes' principle for buoyancy in liquids



Set of 5 density bodies

Set comprising five rectangular prisms made of various materials and a transparent block with a hollow body, all with the same dimensions for demonstrating Archimedes' principle. The bodies have 2-mm bores by which they can be suspended.

Materials: Wood, aluminium, iron, brass, copper

Dimensions of each body: 10x20x45 mm³

P-1000768

Additionally required:

P-1003104 Precision Dynamometer 1N



Cartesian Diver

For demonstrating a body floating, sinking or rising in water. A hollow figure made of coloured glass, with a narrow opening. The figure floats upright in a cylinder filled with water and can be made to float, sink or rise by applying pressure to the rubber cap. The rubber cap fits cylinder diameters of approx. 30 mm to 40 mm, e.g. free-standing cylinder (P-1002871).

Contents:

1 Cartesian diver
1 Rubber cap

P-1002867

Additionally required:

P-1002871 Free-Standing Cylinder, without Graduation



Buoyancy Apparatus

Apparatus for demonstrating buoyancy of fluids, consisting of a flat ground glass tube and a plastic disc with rubber covering to form a base plate to which a long string is attached. The base plate makes a watertight connection with the glass tube and when both are immersed in water, the plate does not sink because buoyancy keeps it pushed up against the tube.

Glass tube: approx. 200 mm x 28 mm diam.

Metal disc: 2 mm x 42 mm diam.

Length of string: approx. 35 cm

P-1000791

Set of 3 Cylinders, Equal in Volume

Set of three cylinders of equal volume and unequal mass each with a hook.

Materials: Aluminium, iron, brass
 Dimensions of cylinders: approx. 40 mm x 20 mm diam.

P-1000752

Additionally required:

P-1020860 Electronic Scales SKX 620 g
P-1002870 Graduated Cylinder, 100 ml

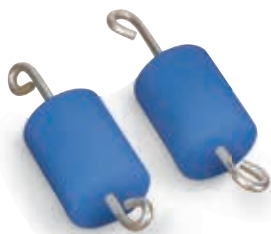

P-1000752

Set of 3 Cylinders, Equal in Mass

Set of three cylinders of equal mass and unequal volume each with a hook.

Materials: Aluminium, iron, brass
 Mass of cylinders: 100 g

P-1000754

Additionally required:

P-1020860 Electronic Scales SKX 620 g
P-1002870 Graduated Cylinder, 100 ml

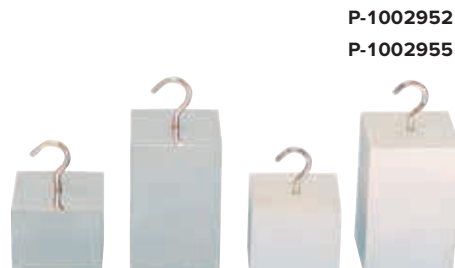

P-1002952

P-1002955

P-1000754

Density Paradox Set

Two identical plastic cylinders with a density close to that of water. If the first is immersed in hot water, it will initially sink but will then float up to the surface after a short time. If the second one is then put into ice-cold water, it will initially float but will then sink to the bottom. The reason for this is that the density of the plastic changes more than that of the water when it is heated or cooled.

P-1003498

Additionally required:

P-1020860 Electronic Scales SKX 620 g

Immersion Blocks

Immersible body of known volume with hook. Can be used in conjunction with scales to determine the density of solid bodies and with a dynamometer for determining buoyancy.

Art. No.	Description
P-1002952	Al, 50 cm ³
P-1002953	Al, 100 cm ³
P-1002954	Fe, 50 cm ³
P-1002955	Fe, 100 cm ³

Additionally required:

P1020860 Electronic Scales SKX 620 g

or

P-1003107 Precision Dynamometer 10 N

P-1002875



P-1003012

P-1002874



Alcohol Meter

Gay-Lussac alcohol meter for determining the alcohol content in percentage by volume of ethanol/water mixtures at a reference temperature of 15°C. Without thermometer, in storage container.

Scale: 0 to 100% vol
 Division: 1%
 Length: 260 mm

P-1002875

Universal Areometer

Areometer for determining the density of liquids in g/ml at a reference temperature of 20°C. Without thermometer, in storage container.

Measuring range: 0.7 – 2 g/ml
 Scale division: 0.02 g/ml
 Length: 310 mm

P-1002876

Set of 3 Areometers

Set of areometers for determining the density of liquids in g/ml at a reference temperature of 20°C / 68°F. Without thermometer, in storage container.

P-1003012

Measuring range	Scale division	Length
0.650 – 1.000 g/ml	0.005 g/ml	315 mm
1.000 – 1.500 g/ml	0.005 g/ml	235 mm
1.500 – 2.000 g/ml	0.005 g/ml	235 mm

Gay-Lussac Pycnometer

Glass body with ground capillary stopper for determining the density of liquids.

Volume: 50 ml

P-1002874

Pressure Container for Determining Weight of Air

Airtight metal can with valve for demonstrating weight of compressed air. With bicycle valve for pumping in air. The weight of the air pumped in is determined by weighing and the volume can be determined by gauging the capacity.

Dimensions: approx. 60x190 mm²
Weight: approx. 100 g

P-1000796

Additionally required:

P-1020859 Electronic Scales SKX 420 g
Bicycle Pump

P-1000796



P-1000766



Set of 7 Cubes for Determining Density

Set of seven cubes made of various materials for determining densities by weighing. Supplied in a storage case.

Materials: Wood, plastic, aluminium, iron, copper, brass, zinc

Side of cubes: 10 mm

P-1000766

Additionally required:

P-1020860 Electronic Scales SKX 620 g



P-1003519

Set of 2 Materials with 4 Different Masses Each

Two sets of test bodies made of the same material but with four different masses for deriving the concept of density in school experiments. Supplied in storage containers.

Materials: Aluminium, PVC

P-1003499

Additionally required:

P-1020860 Electronic Scales SKX 620 g
P-1002870 Graduated Cylinder, 100 ml

Sphere for Weighing Gases 1000 ml

Glass sphere with two taps and nozzles for attaching tubing for demonstrating the weight of air from the difference in weight between the sphere when filled with air and when evacuated.

Weight: 200 g approx.

P-1003519

Additionally required:

P-1020859 Electronic Scales SKX 420 g
P-1012856 Vacuum Hand Pump

P-1003499

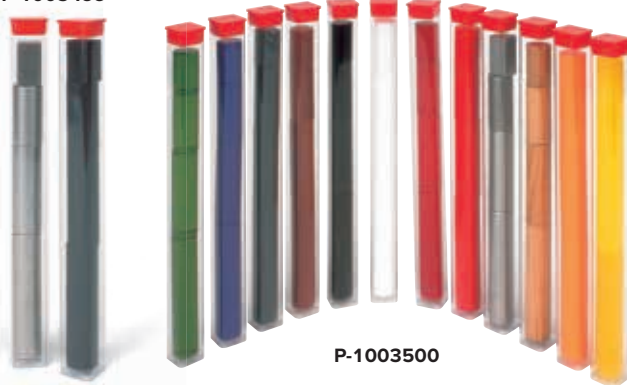

P-1003500

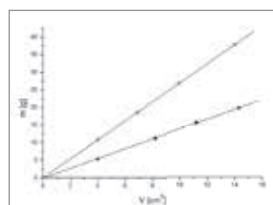

Determining the density of aluminium and PVC

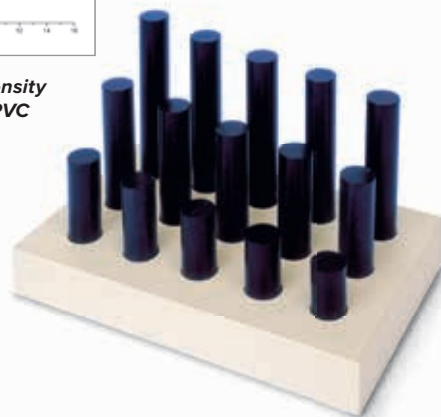

Set of 12 Materials with 4 Different Masses Each

Twelve sets of test bodies made of the same material but with four different masses for deriving the concept of density in school experiments. Supplied in storage containers.

Materials: Wood, polypropylene, polyamide, acrylic (2 colours), polyurethane, phenol, PVC (3 colours), Teflon and aluminium

Densities: 0.71 – 2.71 g/m³

Dimensions: 25 / 35 / 50 / 70 mm x 16 mm diam. approx.

P-1003500

Set of 15 Bodies with 2 Different Densities

Set of 15 test bodies of various masses made of two identical looking materials for deriving the concept of density in experiments at school. Supplied on a storage tray.

Materials: Plastic of density 1.41 g/cm³ and 1.15 g/cm³

P-1003501

Additionally required:

P-1020860 Electronic Scales SKX 620 g
P-1002870 Graduated Cylinder, 100 ml

Additionally required:

P-1020860 Electronic Scales SKX 620 g
P-1002870 Graduated Cylinder, 100 ml



Pascal's Vane Apparatus

For demonstrating the hydrostatic paradox and for quantitative measurements of ground pressure. This pressure is measured through the curvature of a membrane and indicated in magnified form with the help of a lever multiplier. Compensation for comparative measurements is possible. Includes four differently shaped vessels made of glass.

Height of the vessels: 220 mm
 Tube diameter at the bottom: 22 mm
 Total height: approx. 350 mm
 Base-plate area: approx. 260x110 mm²
 Weight: approx. 0.8 kg

P-1002957



Pascal's Pressure Sphere

Glass vessel with movable plungers for demonstrating equal distribution of pressure in all directions, observed by means of water jets forced out under pressure.

Total length: 350 mm
 Diameter: approx. 70 mm

P-1002892

U-Shaped Manometer D

Demonstration manometer for measuring pressure in centimetres of water. The manometer consists of a U-tube open at both ends attached to a fibreboard (MDF) featuring a scale.

Length of each leg: 50 cm
 Measuring range: 0 – 50 cm of water or 0 to 5 kPa
 Tubing diameter: 10 mm
 Dimensions: 200x150x530 mm³
 Weight: approx. 820 g

P-1009714

Additionally recommended:

P-1000793 Blue Food Colouring



Pressure Balance

Introducing the concept of pressure, for comparing pressures, for gas-compression experiments and for demonstrating overpressure and underpressure. Two precision glass syringes of different volumes with under piston and weight pans on stand. Includes 15 disc weights on a storage rod for adding to plunger. Connection between the syringe hoses via a tubing clamp, safety catch for the smaller piston.

Volume of syringes: 10 ml and 50 ml
 Ratio of piston cross-sections: 10:3
 Ratio of piston masses with weight pans: 10:3
 Mass of weights: approx. 400 mN each
 Baseplate dimensions: approx. 140x100 mm²

P-1002653



Hydraulic/Pneumatic Lifting Platform

Complete equipment set for demonstration and practical training such as investigating transmission of hydraulic or pneumatic force, the relationship between force, surface area and pressure as well as verification of Boyle's law. A rugged stand holds a cylinder with piston (60 cm³ volume). The lifting platform is positioned on the piston. Various levels of pressure can be exerted on the piston using a system of tubing with 4 simple hand pumps of different volumes. A hose fitting for connection of a pressure sensor required to record measured values with a datalogger is also included.

Dimensions: approx. 140 mm diam. x 190 mm
 Pump volumes: 3 cm³, 6 cm³, 12 cm³, 20 cm³

P-1003495

U-tube Manometer S

Manometer for measuring pressures in the range 0 to 10 hPa (cm water column). U-tube open on both sides with overflow basin on aluminium base plate with scale.

Includes stand rod on the reverse for attaching to stand base.

Length of arms: 200 mm
 Stand rod: 33 mm x 10 mm diam.
 Base plate: approx. 210x70 mm²
 Weight: approx. 80 g

P-1000792

Additionally required:

P-1000793 Blue Food Colouring

Additionally recommended:

P-1002622 Silicon Tube, 1 m





Communicating Tubes T

Four vertical glass tubes of different shapes linked by a horizontal glass tube demonstrate that liquid levels remain the same regardless of the shape of the vessel.

Height: approx. 195 mm

P-1003509



Outlet Vessel, Metal

Robust metal cylinder with three outlets at various heights for the purpose of investigating hydrostatic pressure due to depth of water by observing the jets of water emerging from the outlets under pressure.

Height: approx. 430 mm

Diameter: approx. 125 mm

P-1009715



Glass Cylinder with 2 Tubes

Glass vessel for demonstrating communicating tubes. Consists of a glass cylinder with two openings and GL screw connections, as well as two differently shaped glass tubes.

Height: approx. 220 mm

P-1002891



Pythagorean Cup

Pythagoras is known to most students today as the author of the Pythagorean Theorem ($a^2 + b^2 = c^2$). There was far more to Pythagoras' philosophy than this: he was a deep thinker on religion, the nature of the soul, and the harmony of the cosmos. With the "Pythagorean Cup" he illustrated to his students the virtues of moderation: when filled halfway, it retains its contents, but if it's too full, all of the liquid drains out through a hole in the bottom. Our Pythagorean cup is manufactured of clear blown glass. The secret of the construction is a siphon, which is built in the centre of the cup. Ideal to explain to your students the principle of a siphon with an historical background.

Height: approx. 250 mm

Diameter: approx. 80 mm

P-1002904



Apparatus for Investigation of Capillary Effects

A horizontal glass tube can be connected to a water reservoir through capillary tubes of different diameters. The smaller the diameter of the capillary tube, the higher the water climbs above the level of the reservoir due to the greater hydrostatic pressure.

Internal diameters of the capillary tubes: 2.0 mm, 1.5 mm, 1.0 mm and 0.5 mm

Height: approx. 165 mm

P-1003510

Blue Food Colouring (not shown)

Powdered food colouring in bottle for use in 30-ml colouring solutions for colouring water in demonstration experiments. One drop of the solution is sufficient to colour 50 ml of water.

P-1000793



Wedge Shaped Vessel

Wedge shaped vessel made of transparent acrylic for demonstrating the surface tension of liquids and capillary forces.

Length: 100 mm

P-1000794

Viscosity measurements using the following substances

- Light oils, machine oils, petroleum, petroleum ether, diesel (mineral oils and fuels)
- Plastic solutions, resin solutions, adhesive solutions, latex dispersions (polymer chemicals)
- Printers' ink, varnish, water-based paints, inks (inks and paints)
- Emulsions, suspensions, solutions, extracts (cosmetics/pharmaceuticals)
- Emulsions, dispersions (paper industry)
- Liquid detergents, washing-up liquid, surfactant solutions (detergents)
- Honey, fruit juice, beer, milk (food industry)
- Gases and mixtures of gases

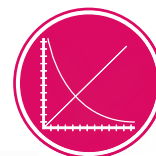

UE1080350

PDF online



P-1008654
P-1008653

P-1012827



Surface Tension Ring

Aluminium ring with a blade for determining the surface tension of liquids. Includes a hook and three threads for suspension from a dynamometer.

Diameter: 60 mm
Weight: approx. 5 g

P-1000797

Additionally required:

- P-1002941 Laboratory Jack
- P-1003102 Dynamometer 0.1 N
- P-1002872 Beaker, 600 ml
- Stand equipment



Glycerine

250 ml of glycerine in aqueous solution for experiments on viscosity.

In glass bottle

Concentration: 85%

P-1007027

Falling Sphere Viscometer

Höppler-type falling sphere viscometer for simple but accurate measurement of dynamic viscosity of transparent Newtonian fluids. The sphere rolls and slides inside an inclined cylindrical tube filled with the fluid to be tested. The viscosity is measured in $\text{mPa} \cdot \text{s}$ and is derived directly from the time the sphere takes to fall a specified distance through the fluid in the measuring tube. The tube can then be turned upside-down so that time the sphere takes to fall back can also be measured. The tube is situated inside a water bath, which can be filled with water at a specific temperature in order to measure how viscosity depends on temperature.

Includes:

- Falling sphere viscometer with 6 spheres and 1 ball gauge
- Thermometer 0 – 100° C
- Cleaning set

Test certificate with accurate values for sphere constant K and density ρ for converting duration of fall to actual viscosity.

Technical data

Measuring range:	0.5 $\text{mPa} \cdot \text{s}$ to $7 \cdot 10^4 \text{ mPa} \cdot \text{s}$ (as per DIN 53015)
	$> 7 \cdot 10^4 \text{ mPa} \cdot \text{s}$ (for sphere fall times $> 300 \text{ s}$)
Measurement precision	0.5 to 2% (depending on spheres used)
Spheres:	#1, #2: Borosilicate glass #3, #4: Ni-iron #5, #6: Steel
Diameter of spheres:	11.00 to 15.81 mm
Diameter of measuring tube:	15.95 mm
Fall times for spheres	30 to 450 s
Length of measured distance:	100 mm in both directions
Operating angle:	10° to vertical
Additional working angles	70°, 60°, 50° to horizontal
Volume when full:	40 ml
Permissible temperature range:	-60°C to +150°C
Dimensions:	approx. 180x220x330 mm ³
Weight:	approx. 3.1 kg

P-1012827

Additionally required:

- P-1002811 Digital Stopwatch

Additionally recommended:

- P-1002622 Silicone Tubing (2x)
- P-1008654 Immersion/Circulation Thermostat (230 V, 50/60 Hz)
- or
- P-1008653 Immersion/Circulation Thermostat (115 V, 50/60 Hz)

Experiment Topics:

- Elastic deformation of flat bars
- Determining modulus of elasticity

Experiment Topics:

- Torsion on cylindrical bars
- Determining the shear modulus



Advantages

- Load characteristics of the strain gauge may be ignored
- Measurements can be set up with the material samples supported on both sides or clamped at one end



Apparatus for Measuring Young's Modulus

Measuring apparatus for investigating the elastic deformation of rods of flat geometry and for determining the modulus of elasticity. Features a strain gauge unit for determining the deformation of electrically conducting material samples. The strain gauge unit is electrically connected to the material sample in such a way that placing of the probes on the sample is determined with a high degree of sensitivity and displayed with the help of two LEDs. The bending of the material sample with the weight suspended is measured to an accuracy of 0.01 mm and the modulus of elasticity can then be calculated from the reading.

Battery for strain gauge unit: 9 V, 6F22
 Dimensions: 550x280x500 mm³
 Weight: approx. 5.5 kg

Contents:

- 6 Flat steel rods (w: 15 mm, l: 200 / 300 / 400 mm, thickness: 2 / 3 mm)
- 1 Strain gauge unit
- 1 Horizontal beam with stand
- 2 Knife-edge bearings
- 1 Clamping chuck
- 1 Set of weights and retaining clamps

P-1018527

Young's Modulus Supplementary Set (not shown)

Set of flat bars with the effective lengths of 200, 300 and 400 mm and the widths of 10 and 20 mm for measurement of elastic deformation and modulus of elasticity using the modulus of elasticity equipment set (P-1018527).

Contents:

- 12 Flat bars made of steel (thickness: 2 / 3 mm)
- 6 Flat bars made of aluminium (thickness: 3 mm)

P-1018528



Advantages

- Simple set-up and operation
- Static and dynamic measurements possible without time-consuming reconfiguration

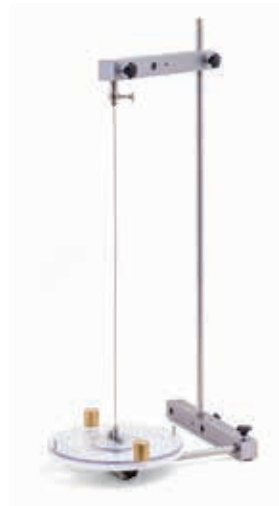

Torsion Apparatus

Measurement apparatus for investigating torsion as applied to bars with cylindrical geometry and to determine both directivity values and shear modulus. With a scaled disc for torsion angle measurement and a pendulum disc for transmission of torsional forces to the clamped material samples in the case of static measurements as well as for the determining moment of inertia in the case of dynamic measurements. The period of oscillation is measured electronically in the dynamic case using a light barrier. The approximate variables and the shearing modulus are derived from the measurements.

Dimensions: 570x300x300 mm
 Weight: approx. 2.3 kg

Contents:

- 1 Cylindrical bar made of steel (d: 2 mm, l: 500 mm)
- 1 Basic unit of torsion apparatus
- 1 Base plate for light barrier (P-1000563)

P-1018550

Additionally required:

- P-1003370 Dynamometer, Colour-Coded, 2.5 N**
- P-1003371 Dynamometer, Colour-Coded, 5 N**
- P-1000563 Light Barrier**
- P-1001033 Digital Counter (230 V, 50/60 Hz)**
- or
- P-1001032 Digital Counter (115 V, 50/60 Hz)**

Supplementary Set for Torsion Apparatus (not shown)

Set of round bars for measuring torsion, directivity and shearing modulus with the torsion apparatus (P-1018550).

Contents:

- 1 Cylindrical bar made of steel (d: 2 mm, l: 300 mm)
- 6 Cylindrical bars made of brass / copper / aluminium / (d: 2 mm, l: 300 / 500 mm)
- 2 Cylindrical bars made of aluminium (d: 3 / 4 mm, l: 500 mm)

P-1018787



Vacuum Chamber with Hand Pump

Inexpensive, transparent plastic vacuum chamber for basic experiments with low pressure. Hand pump integrated into base plate, bleed valve and manometer for measuring pressure down to 330 hPa.

Dimensions: approx. diam. 200 mm, H = 250 mm

P-1010126

Additionally required:

P-1010125 Set of 100 Balloons



Set of 100 Balloons

Set of 100 balloons for use in vacuum chamber with hand pump.

P-1010125



Magdeburg Hemispheres

To demonstrate Von Guericke's historical experiment on the effect of atmospheric air pressure. Two plastic hemispheres equipped with handles can be joined vacuum-tight using the insertable rubber sealing ring. One hemisphere is equipped with a stopcock and hose connection. Including air hose.

Vacuum connection: 8 mm

Diameter: 120 mm

Hose length: 110 mm

P-1003208

Additionally required:

P-1012856 Vacuum Hand Pump



Magdeburg Plates

Equipment set for demonstrations and practical teaching of Guericke's historical experiment investigating the effect of atmospheric pressure. Includes nozzle for tubing, a simple hand pump and tubing with built-in directional valves. Two transparent acrylic plates with handles that can be held together with a coarse vacuum between them. Three sealing rings of various sizes are supplied for sealing the plates. This allows the dependency of the force on the contact area to be investigated.

Acrylic plates: approx. 13x105 mm diam.

Sealing rings: approx. 65 mm, 80 mm, 100 mm diam.

P-1003496

Vacuum Bell Jar

Vacuum bell jar made of glass with grip knob and polished flange to be set on top of the vacuum experiment plate (P-1003166).

Inner diameter: 190 mm
Total height: 220 mm

P-1020809



Electric Doorbell

Bell for demonstrating electro-magnetic operation of apparatus and verifying that sound waves do not propagate in a fine vacuum (< 1 hPa). Open acrylic housing with 4-mm safety sockets.

Power supply: 6 V AC
Dimensions: 100x95x50 mm³

P-1003170

Additionally required:

Vacuum Chamber

Vacuum Pump

P-1003316 Transformer with Rectifier 3/ 6/ 9/ 12 V, 3 A (230 V, 50/60 Hz)

or

P-1003315 Transformer with Rectifier 3/ 6/ 9/ 12 V, 3 A (115 V, 50/60 Hz)



Vacuum Experiment Plate

Experiment plate for the assembly of a vacuum chamber in conjunction with the vacuum bell jar (P-1020809) for experiments in the coarse and fine vacuum range. Metal plate with sealing ring on a tripod, hose connection of the pump-side and ventilation cock. Includes two-pole current feed via 4-mm safety sockets and cable of approximately 1 m length with 4 mm safety plugs, plus a central bore with M12 thread for attaching experimental equipment.

Diameter: 250 mm
Height: 90 mm
Electrical limit specs.: max. 48 V, max. 12 A
Vacuum connection: 2 hose nozzles 12 mm and 8 mm diam.

P-1003166

Additionally required:

P-1020809 Vacuum Bell Jar

P-1003317 Rotary-Vane Vacuum Pump, Two-Stage

P-1002619 Vacuum Hose 8 mm

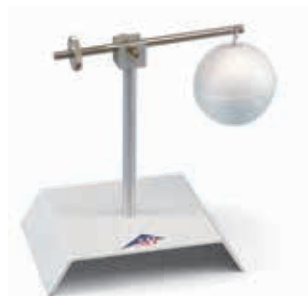

Baroscope

Beam balance on base with suspended polystyrene ball and adjustable counterweight for demonstrating buoyancy on a body due to atmospheric pressure. At a state of equilibrium a Baroscope is placed in a vacuum bell jar under atmospheric pressure. The air in the bell jar is then evacuated, the Styrofoam sphere falls on account of the reduction in lift.

Styrofoam sphere: 50 mm diam.
Base: approx. 120x90 mm²
Height: approx. 125 mm

P-1003169

Additionally required:

Vacuum Chamber

Vacuum Pump

Vacuum Recipient

Inexpensive vacuum recipient made of transparent acrylic for experiments in coarse and fine vacuums. Comprises a base and vacuum cylinder with venting valve, manometer, inlet tap, entrance for contacts and rubber ring.

Volume: approx. 9 l
Leakage rate: < 0.5 mbars/h
Base plate: approx. 320x320x10 mm³
Vacuum cylinder: approx. 200 mm x 240 mm diam.
Thickness of walls: 5 mm
Weight: approx. 2.9 kg

P-1009943

Additionally required:

P-1012831 Vacuum Tubing, 4 mm

P-1003317 Rotary-Vane Vacuum Pump, Two-Stage

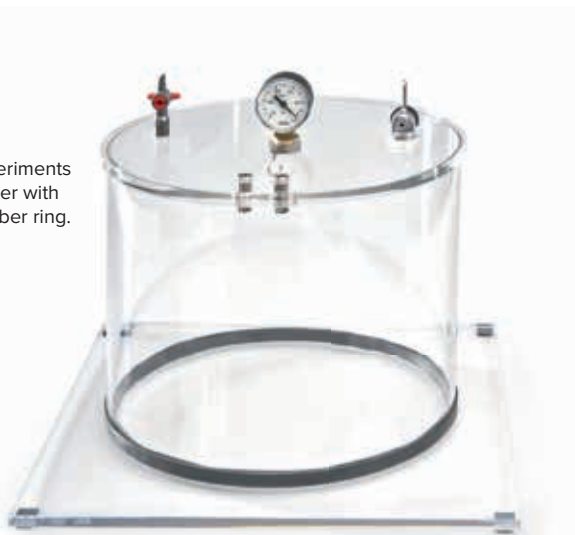

	P-1012831	P-1012830	P-1002619	P-1002620
Length	1 m	1 m	1 m	1 m
Internal diameter	4 mm	6 mm	8 mm	10 mm
Wall strength	4 mm	4 mm	5 mm	5 mm
Temperature range	-30° up to + 85°	-30° up to + 85°	-30° up to + 85°	-30° up to + 85°

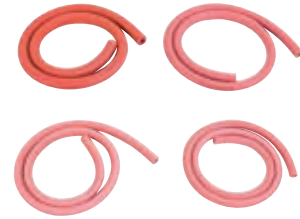

Vacuum Hoses

Vacuum hoses made of natural rubber according to DIN 12865. Colour red.



Piston Vacuum Pump

Robust two-stroke piston pump for vacuum experiments, for final vacuum pressures down to 400 hPa. Air is pumped out on both the upward and the downward stroke of the piston. Includes carrying rod with handles and heavy base plus vacuum hose diam. 5 mm.

Final pressure: 400 hPa
 Tubing nozzle: 5 mm diam.
 Dimensions: approx. 160x235x560 mm³
 Weight: approx. 1.7 kg

P-1000798



Vacuum Hand Pump

Simple mechanical air pump for filling and evacuating small containers; equipped with an ergonomic handle, a manometer with a pointer that rotates through a full 360°, a ventilation valve, two hoses (long and short) and six connecting adaptors.

Manometer: -980 hPa – 4000 hPa
 Tubing nozzle: 8.5 mm diam.
 Hose: 850 mm x 6.5 mm internal diam.
 65 mm x 4.5 mm internal diam.
 Dimensions: approx. 180x60x260 mm³
 Weight: approx. 0.3 kg

P-1012856



Rotary-Vane Vacuum Pump, One-Stage

High performance, compact, one-stage, oil-sealed rotary vane pump for vacuum experiments. With thermal overload protection, handle, air valve, manometer and hose nipple. Includes pump oil.

Suction capacity: 100 l/min
 Final pressure: 0.05 hPa
 Motor power: 245 W
 Manometer: 0 – 1000 hPa
 Hose nipple: 10 mm diam.
 Supply voltage: 115 V or 230 V, 50/60 Hz
 Dimensions: approx. 335x138x250 mm³
 Weight: approx. 8 kg

P-1012855



Rotary-Vane Vacuum Pump, Two-Stage

High performance, compact, two-stage, oil-sealed rotary vane pump for vacuum experiments. With thermal overload protection, handle, air valve, manometer and hose nipple. Includes pump oil.

Suction capacity: 100 l/min
 Final pressure: 0.003 hPa
 Motor power: 245 W
 Manometer: 0 – 1000 hPa
 Hose nipple: 10 mm diam.
 Supply voltage: 115 V or 230 V, 50/60 Hz
 Dimensions: approx. 335x138x250 mm³
 Weight: approx. 11 kg

P-1003317



A. Metering Valve, DN 16 KF
Adjustable using micrometer screw.
Connection: DN 16 KF
P-1018822



B. 2-Way Ball Valve DN 16 KF
Connection: DN 16 KF
Length: 100 mm
P-1002923



C. Crosspiece DN 16 KF
Connection: DN 16 KF
Dimensions: 80x44 mm²
P-1002924

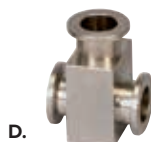

D. T-Piece DN 16 KF
Connection: DN 16 KF
Dimensions: 50x44 mm²
P-1002925



E. Adaptor Flange DN 16 KF / NS 19/26
Adaptor flange for connecting components with internally ground nozzles, e.g. gas discharge tube (P-1002905, to ISO-KF systems).
Connection: DN 16 KF
Core: 19/26 NS
Length: 40 mm
P-1002929



F. Adaptor Flange DN 16 KF / Shaft 12 mm
Adaptor flange for connecting a vacuum hose to ISO-KF systems.
Connection: DN 16 KF
Tubing nozzle: 12 mm
Length: 40 mm
P-1002928



G. Ventilation Valve DN 16 KF
Connection: DN 16 KF
Dimensions: 36 mm x 26 mm diam.
P-1002926



H. Dummy Flange DN 16 KF
Connection: DN 16 KF
P-1002927



Rotary-Vane Vacuum Pump, P 4 Z

Compact, two-stage rotary pump with high suction capacity. Automatic lubrication of the rotary valve and ball bearings using optimized oil pressure increases the final pressure levels achievable, stabilizes the pump temperature and prolongs the pump's working life. Includes direct drive with elastic coupling. Device exhibits good resistance to chemicals and a high degree of water vapour compatibility. A suitable mechanism prevents the oil from rising back to contaminate the recipient. Lightweight device that operates with low noise. High-quality parts make the device capable of continuous operation. The pump is complete and ready for connection with a full complement of oil, centring ring, locking ring, motor protection circuit breaker, mains switch and connection cable with mains plug.

Connecting flange:	DN 16 KF
Suction performance (Pneurop):	77/92 l/min at 50/60 Hz
Final pressure (without partial gas ballast):	2x 10 ⁻⁴ hPa
Final pressure (with total gas ballast):	1x 10 ⁻² hPa
Water vapour tolerance:	40 hPa
Motor output:	200 W
Oil capacity:	530 ml
Supply voltage:	100 / 115 / 230 V, 50/60 Hz
Dimensions:	approx. 415x150x235 mm ³
Weight:	approx. 17.5 kg

P-1002919

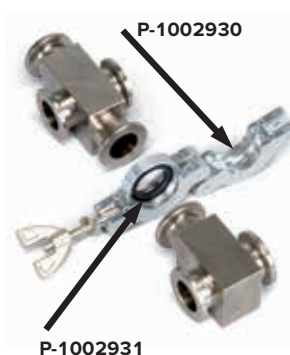

Tension Ring DN 10/16 KF
Tension ring for mechanically secure connection of ISO-KF components.
Connection: DN 16 KF
P-1002930

KF External Centring Ring DN 10/16 KF
Rubber sealing ring for ISO-KF connections.
P-1002931



Pirani Vacuum Gauge

An easily programmable desktop device for measurement and control in fine and coarse vacuums using a Pirani vacuum gauge. Includes a clearly arranged membrane keypad, measuring line (2.5 m) and mains cable.

Vacuum connection:	DN 16 KF
Measuring range:	1100 – 0.001 hPa
Measurement uncertainty:	< 20% of the display value
Display:	Digital LED display in mbar, Pa, psi, torr
Digit height:	10 mm
Readout:	5 per s
Threshold switch:	2x 230 V, 2 A, independently adjustable
Switching accuracy/hysteresis:	± 1 digit
Permissible overload:	2 bar absolute
Power consumption:	max. 15 W
Supply voltage:	100 / 115 / 230 V, 50/60 Hz
Dimensions:	approx. 90x120x90 mm ³
Weight:	approx. 0.9 kg

P-1012514

Jet Nozzle (Flow Laminator)

Nozzle for emitting a near laminar air stream, e.g. for experiments with the set of drag and lift objects or experiments on recoil. Mounted on a stem. The very light air nozzle contains no moving parts and generates no spin. It spreads out the air stream from a connected fan. Air that comes out of the tubular nozzles near the plastic ring mixes with the secondary air to form an overall air stream of a large diameter. Includes a hose.

- Air inlet: 33 mm
- Air outlet: 120 mm
- Dimensions: approx. 255x150 mm²
- Stand holder: 10 mm
- Weight: approx. 350 g

P-1000758

Additionally required:

P-1000606 Air Flow Generator (230 V, 50/60 Hz)

or

P-1000605 Air Flow Generator (115 V, 50/60 Hz)

Stand Equipment



P-1000758

Component Balance

Scales for measuring components with holding mechanism for measuring air resistance and buoyancy of bodies from set P-1000760. On rod.

- Measuring range: 0 – 0.3 N
- Diameter of the scale: 170 mm
- Dimensions: approx. 350x220 mm²
- Rod diameter: 10 mm
- Weight: approx. 0.9 kg

P-1000761



P-1000761

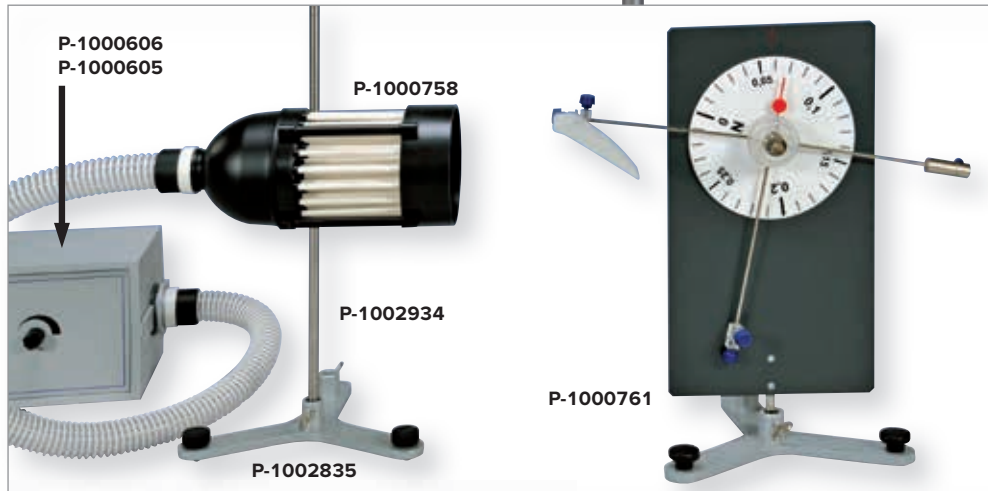

Air Flow Generator

Fan allowing continuous adjustment of air flow. Includes a hose.

- Hose length: approx. 1.5 m
- Power consumption: max. 1100 W
- Dimensions: approx. 300x180x170 mm³
- Weight: approx. 4.4 kg

Air Flow Generator (230 V, 50/60 Hz)

P-1000606

Air Flow Generator (115 V, 50/60 Hz)

P-1000605



Set of bodies for air resistance and buoyancy experiments

Set of 7 wooden models on stems for measuring buoyancy and fluid resistance of various bodies in laminar air flows. Including storage block.

Contents:

- 1 streamlined body, smooth, l = 120 mm
- 1 streamlined body, rough, l = 120 mm
- 1 ball, d = 50 mm
- 1 circular disc, d = 47 mm
- 1 circular disc, d = 68 mm
- 1 hemisphere, d = 50 mm
- 1 wing profile, l = 150 mm

P-1000760

Additionally required:

P-1000758 Jet Nozzle (Flow Laminator)

P-1000761 Component balance



Air Flow Apparatus

Apparatus for demonstrating air flow patterns around bodies of different shapes. The air flow patterns can be projected on to a wide screen using an overhead projector. Two strings are fastened on one side at equal distances between two glass plates. The strings move according to the air currents between the two glass plates. Bodies of different shapes can be introduced in the air current. The inserted bodies can be moved to various positions in the air current from outside. Includes a hose.

Dimensions: approx. 385x310x75 mm³
 Weight: approx. 3.2 kg

Contents:

- 1 Air flow apparatus
 - 1 Circular body
 - 1 Rectangular body
 - 1 Streamlined body
 - 1 Wing section
 - 2 Bodies to demonstrate narrowing of flow
 - 1 Hose
- P-1000765**

Additionally required:

- P-1000606 Air Flow Generator (230 V, 50/60 Hz)**
- or
- P-1000605 Air Flow Generator (115 V, 50/60 Hz)**

Additionally recommended:
Overhead Projector



Example of an air flow pattern

Laminar Flow Apparatus

For demonstrating and investigating the laminar flow properties of water. The emergence of currents in water, the flow of current in the case of straight laminar flow and the overflow of differently shaped bodies can be studied. The flow of current at a narrows can also be demonstrated clearly. A rectangular piece of velour paper is placed in the apparatus consisting of an upper and lower trough. Owing to capillary forces, water from the upper trough is drawn in by the paper. The water flows down into the velour paper. The flow of water in the upper level is marked with a dye at constant intervals. Owing to the low speed of flow of approx. 2 mm/s, the development of currents can be observed with the help of the dye. After the velour paper has been dried, a lasting current pattern remains, which can be copied and evaluated.

Dimensions: approx. 220x140x240 mm³
 Weight: approx. 1 kg

P-1006784

Contents:

- 2 Acrylic glass basins
- 1 Mask
- 20 Sheets of velour paper with cut-outs
- 1 Mini-flask with dye
- Swab for dye
- Rubber gloves



WAVES & SOUND

Experiment Topics:

- Straight-line propagation of microwaves
- Reflection, absorption and transmission
- Shielding from microwaves
- Experiments on polarisation
- Experiments on diffraction and interference
- Transmission of information



Microwave Set

Equipment set for conducting wave optics experiments involving wavelengths in the cm range. A transmitter with a horn antenna radiates a narrow beam of linearly polarised electromagnetic waves with a wavelength of about 3 cm. The direction of polarisation can be altered by rotating the antenna around the axis of propagation. To detect the waves, a horn antenna receiver and a microwave sensor are provided. A control unit converts the intensity of the signal received into a proportionally large output voltage that can be measured using a voltmeter. It is also possible to switch on an acoustic signal with a volume that is proportional to the intensity of the signal.

Oscillator frequency:	9.4 GHz (P-1009951) 10.5 GHz (P-1009950)
Power of transmitter:	10 – 25 mW
Internal modulator frequency:	approx. 3 kHz
Acoustic signal:	Switchable
External modulation:	100 Hz – 20 kHz, 1 V max.
Output voltage:	10 V max.
Receiver with horn antenna:	Silicon diode with resonator
Microwave sensor:	Silicon diode with resonator
Dimensions of basic apparatus:	approx. 160x200x75 mm ³

Contents:

- 1 Control unit
- 1 Plug in power supply
- 1 Transmitter with horn antenna
- 1 Receiver with horn antenna
- 1 Microwave probe
- 1 Microwave bench, 800 mm
- 1 Microwave bench, 400 mm with plate holder
- 1 Reflection plate 180x180 mm²
- 1 Polarisation grating, 180x180 mm²
- 1 Absorption plate, fibreboard, 180x180 mm²
- 1 Paraffin prism
- 1 Stand for prism
- 1 Plate with double slit
- 1 Cover plate for double slit

**Microwave Set 9.4 GHz (230 V, 50/60 Hz)
P-1009951**

**Microwave Set 10.5 GHz (115 V, 50/60 Hz)
P-1009950**

Additionally recommended:

P-1013526 Analogue Multimeter ESCOLA 30

Note:

Our recommendations for wave optics experiments using visible light can be found in the section "Light and optics".

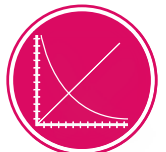

UE3060300
PDF online

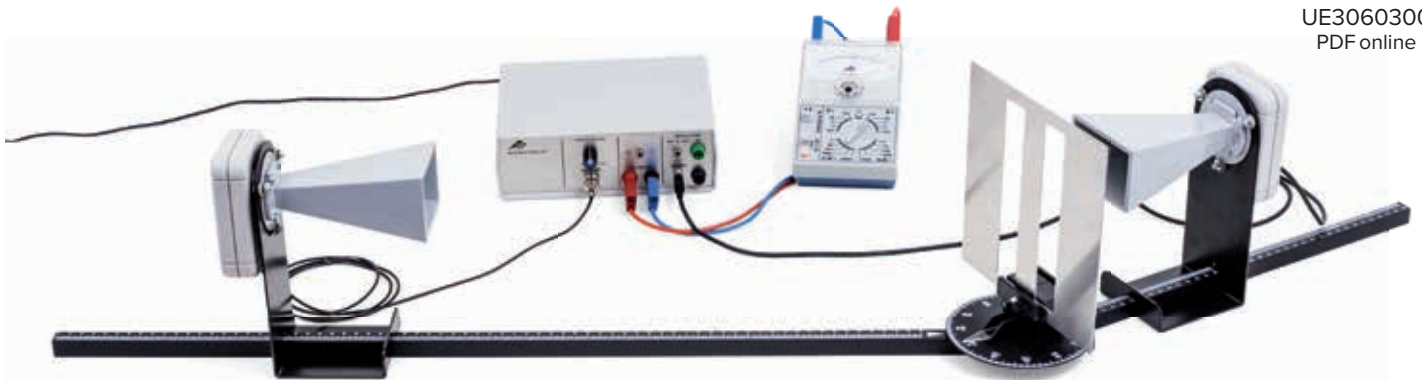

Diffraction by a double slit



Paraffin Prism

Plastic prism filled with paraffin for use with microwave set (P-1009950 or P-1009951).

P-4008112

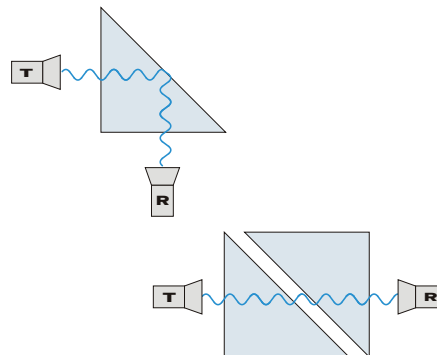

Schematic for tunnelling effect (T: Transmitter, R: Receiver)

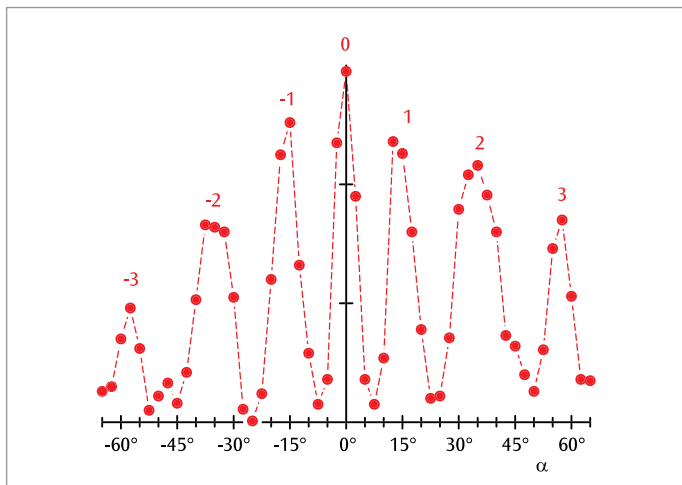

Intensity distribution resulting from the diffraction of microwaves at a pair of slits

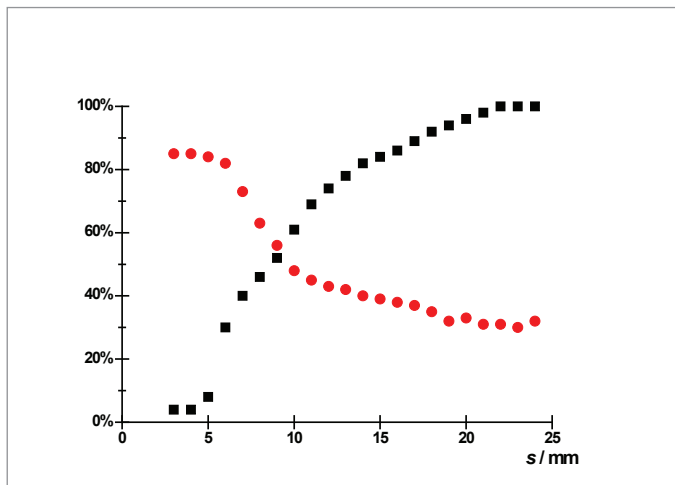

Relative intensity as a function of distance between the paraffin prisms

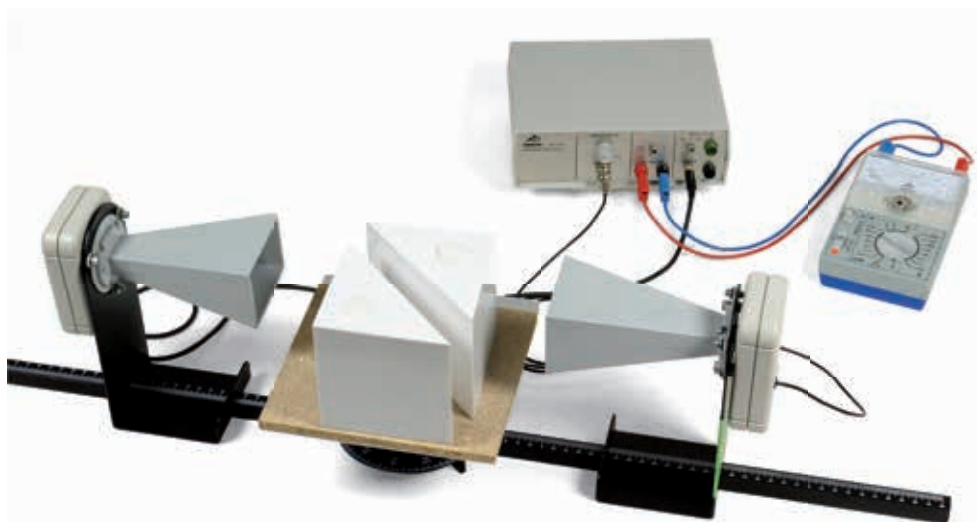

Experiment to demonstrate tunnelling effect with two paraffin prisms

Experiment Topics:

- Generation of circular and straight waves
- Reflection
- Refraction
- Diffraction
- Interference
- Doppler effect



Ripple Tank PM02

Equipment set with ripple tank for demonstrating and investigating properties of waves using the example of waves in water. The ripple tank is a shallow tank with a glass floor inside an aluminium frame, which can be filled with water. The tank can be aligned such that it is horizontal by means of adjustable feet. It is possible to generate both circular or straight waves in the tank by means of localised oscillations in air pressure and the frequency and amplitude of those waves can be set up using a control unit. An external counter can be connected to the control unit in order to measure frequency. An LED lighting system illuminates the ripple tank from above and takes the form of a stroboscope for which both asynchronous and synchronous frequencies can be set. Underneath the tank, there is an inclined mirror which projects the waves onto a viewing screen. Includes a drawer for storage of accessories and carrying handles for transport. Includes 12 V AC plug-in power supply.

Frequency range:	Continuously adjustable, 1 – 60 Hz
Stroboscope lighting:	LED
Terminals for frequency counter:	4-mm safetysockets
Power supply:	100 – 240 V plug-in power supply
Dimensions of tank structure:	approx. 400x300x320 mm ³
Dimensions of projection screen:	approx. 375x320 mm ²

Contents:

- 1 Ripple tank with projection mirror, viewing screen and lighting system
- 1 Control unit
- 1 Plug-in power supply
- 1 Module for generating straight waves
- 1 Module for generating circular waves
- 1 Module for generating two interfering circular waves
- 1 Long hose
- 3 Obstructing bodies for reflection and refraction (prism, biconcave lens and biconvex lens)
- 4 Obstructing bodies for setting up a single slit and a double slit
- 1 Drainage hose

P-1017591



Reflection of water waves at a "concave mirror"



Refraction of water waves at a converging lens

Experiment Topics:

- Excitement of periodic and non-periodic waveforms
- Deflection, phase and amplitude
- Frequency and wavelength
- Phase and group velocities
- In-phase and out-of phase superimposition of waves
- Reflection of a wave
- Standing waves

Water Wave Channel

Wave channel for demonstrating or investigating the basic properties of waves using waves in water. An acrylic duct is filled with water and a sinusoidal wave is generated that propagates with no reflection at the end thanks to an absorber mechanism. The frequency and thus the wavelength of the resulting movement can be varied continuously. In order to investigate reflection, the absorber at the end can be removed. Two exciting mechanisms are supplied that can be operated in or out of phase and the waves they generate can be viewed separately or superimposed. By applying a pulsed input to the exciters, non-periodic waves can be generated.

Supply voltage: 9 – 12 V DC
Power consumption: 40 W max.
Connectors: 4 mm safety sockets
Frequency range: Continuously adjustable
Dimensions: approx. 1500x150x290 mm³
Weight: approx. 12.6 kg

P-1000807

Additionally required:

P-1003312 DC Power Supply 0 – 20 V, 0 – 5 A (230 V, 50/60 Hz)

or

P-1003311 DC Power Supply 0 – 20 V, 0 – 5 A (115 V, 50/60 Hz)

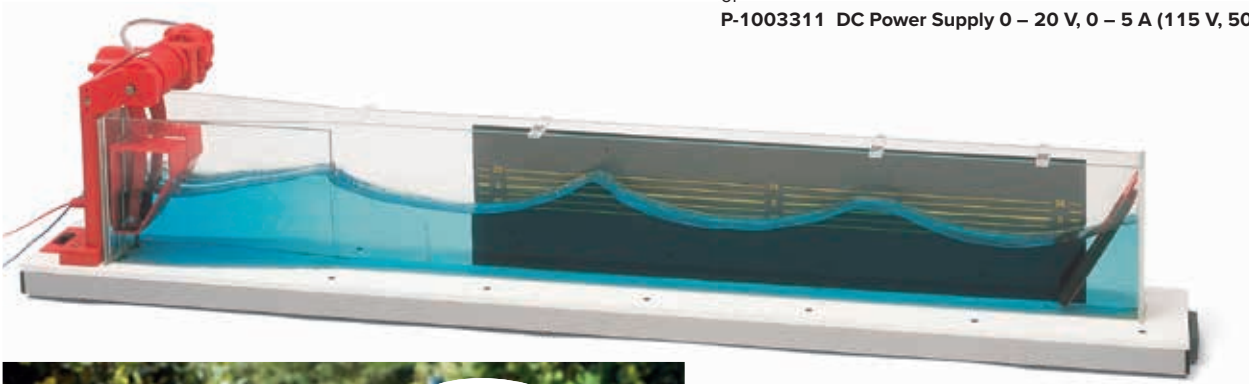

Helical Spring Snakey

Very long helical spring for demonstrating and investigating transverse and longitudinal waves.

Length: 2 m up to 14 m
Total number of turns: 1300
Coil diameter: approx. 25 mm
Weight: approx. 1400 g

P-1008687



Coil Spring Slinky

Long coil spring for demonstrating the propagation and reflection of longitudinal waves.

Length: 0.2 m up to 5 m
Total number of turns: 330
Coil diameter: approx. 70 mm
Weight: approx. 550 g

P-1003516

Accessories for Spring Oscillations

Accessories ideal for vibration generator (P-1000701) for demonstrating standing longitudinal waves in a coil spring. Consisting of angled stand rod, coil spring and connector pin for attachment of the spring to the vibration generator.

Rod: 450 mm x 8 mm diam.
Spring constant: 3.9 N/m

P-1000703

Additionally required:

P-1000701 Vibration Generator

P-1009957
P-1009956

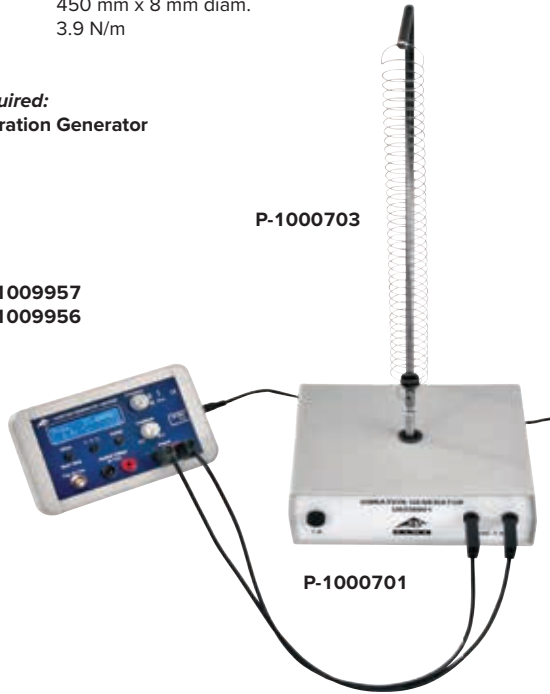

Resonance Wire, Ring Shaped

Accessories for vibration generator (P-1000701) for demonstrating the vibration knots in determination of different frequencies. Wire ring with 4 mm plugs.

Diameter: 290 mm

P-1000707

Additionally required:

P-1000701 Vibration Generator

P-1009957
P-1009956

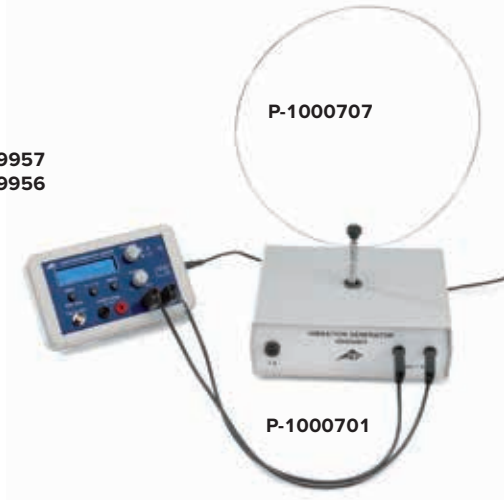

Accessories for Rope Waves

Accessories ideal for vibration generator (P-1000701) for the investigation of standing transversal waves and their wavelengths as a function of the rope tension and the frequency. Consisting of a base plate with stand rod, holder for dynamometer, stand rod with pin, deflection device and rubber rope.

Rope: 1 m
Base plate: approx. 180x180x25 mm³

P-1008540

Additionally required:

P-1000701 Vibration Generator

P-1003106 Dynamometer 5 N

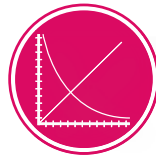

UE1050700
PDF online

P-1008540

P-1003106



P-1000702
P-1000701

Vibration Generator

Tough vibration generator for exciting oscillations and waves mechanically, e.g. in coil springs, a rubber cord, a wire ring or a Chladni plate. In robust plastic housing including mounting pin with 4 mm socket for attaching accessories (Chladni plates, resonance wire, rubber band etc.). Including holder for stand rod (up to 8mm diam.) on the rear side of the apparatus for the demonstration of standing waves in a coil spring. The generator is equipped with overload protection.

Connection: via 4 mm safety sockets

Impedance: 8 Ω

Frequency range: 0 up to 20 kHz

Overload protection: 1 A fuse

Dimensions: approx. 200x160x70 mm³

Weight: approx. 1.4 kg

P-1000701

Additionally required:

P-1009957 Function Generator FG 100 (230 V, 50/60 Hz)

or

P-1009956 Function Generator FG 100 (115 V, 50/60 Hz)

P-1002849 Pair of Safety Experiment Leads, 75 cm, Black

Rubber Band

For demonstrating stationary waves and wave propagation e.g. Using the vibration generator (P-1000701). Wound on a board, 25 m, 2 mm diam.

P-1000702

Additionally required:

P-1000701 Vibration Generator

P-1009957
P-1009956

P-1000701

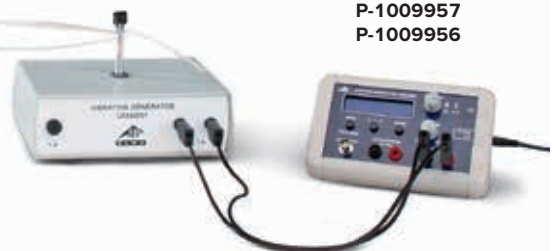



P-1000706



P-1000705

Chladni's Plates

Inexpensive metal plates for generating acoustically excited figures in fine dry sand, as in the experiment by Chladni. To be used for instance in conjunction with vibration generator (P-1000701). With 4 mm plugs.

Chladni Plate, circular, 240 mm diam.

P-1000705

Chladni Plate, square, 180x180 mm²

P-1000706

Additionally required:

P-1000701 Vibration Generator



Advantages:

- Rotor, coreless
- High starting torque
- Low moment of inertia

DC Motor 12 V

Compact experiment motor – can also be used as a tachogenerator, oscillation generator or for the excitation of rope waves. The motor has a coreless rotor and thus has a high starting torque at a lower moment of inertia. It is characterised by a very short starting time, smooth running and low running noise. On its axis, the motor has a threaded bush with a screw on retaining pulley. Thus, plates and levers can also be fixed on to the axis.

Nominal voltage/current: 12 V/260 mA DC

Run-up voltage/current: 0.5 V/45 mA DC

Power consumption: 3.6 W

Nominal speed: 3900 rpm

Nominal rated torque: 0.5 Ncm

Direction of rotation: reversible

Connection: via 4-mm safety sockets

Dimensions in mm: approx. 130x55 mm²

Weight: approx. 200 g

P-1001041



Band Wave Device

Robust apparatus for demonstrating transverse standing waves on a rope and investigating how wavelength depends on the tension in the rope and on the frequency.

Dimensions: approx. 700x150x230 mm³

Weight: approx. 4.4 kg

Contents:

- 1 Chassis
- 1 Rubber cord
- 1 Pulley
- 1 Axle clip
- 2 Axle rods
- 2 Universal clamps
- 2 Stand rods, 400 mm
- 1 Dynamometer, 5 N

P-1000808

Additionally required:

P-1001041 DC Motor 12 V

P-1001038 Sine-Wave Generator

P-1000866 Transformer 12 V, 25 W (230 V, 50/60 Hz)

or

P-1000865 Transformer 12 V, 25 W (115 V, 50/60 Hz)



Wave Machine, Manual

Demonstration equipment for displaying propagation, reflection, diffraction and superimposition of transverse waves. A chain of wooden double-ended pendulums joined together by a bifilar thread. Two handles allow the chain to be held by hand and excited.

Number of double pendulums: 79
 Length: 3 m
 Weight: approx. 0.8 kg

P-1003524

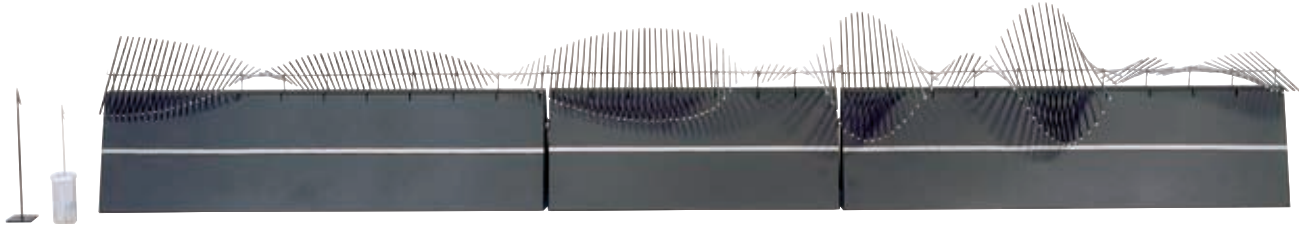

Experimental Topics:

- Propagation of a moving wave
- Wavelength, frequency and phase velocity
- Reflection of waves at fixed or moving ends
- Standing waves and resonance in the case of fixed or moving ends
- Constructive and destructive reinforcement of waves
- Propagation and speed of communication for a disturbance of equilibrium.
- Reflection of a disturbance of equilibrium at fixed or moving ends
- Damping of moving waves
- Reflection at a transition (experiment only possible with full set)
- Coupling at a transition (experiment only possible with full set)

Demonstration Wave Machine, Complete Set

Supplement to the demonstration wave machine comprising a module with short pendulum bars, a transition module and two module couplers. If the two models with differing bar lengths and thus differing wave velocities are coupled together, then reflections can be observed at the point where they are joined together. This can be avoided by adding the transition module.

Length of bar module 1: 460 mm
 Length of bar module 2: 230 mm
 Length of bars for transition module: 230 – 460 mm
 Total length: 2440 mm

P-1003491

Drive Unit for Wave Machine

For continuous operation of the demonstration wave machine at a continuously adjustable frequency. Coupling between the crank disc and connecting rod is achieved by a magnetic engagement mechanism.

Stroke: 10 mm or 32 mm
 Frequency: approx. 275 mHz ... 2.85 Hz
 Power supply: Plug-in power supply, 12 V AC, 500 mA
 Dimensions (without base): approx. 60x90x160 mm³
 Weight (including plug-in power supply): approx. 640 g

Drive Unit for Wave Machine (230 V, 50/60 Hz)

P-1021156

Drive Unit for Wave Machine (115 V, 50/60 Hz)

P-1021443

Additionally required:

P-1001045 Barrel Foot 0,9 kg

Demonstration Wave Machine, Single Module

Wave machine for conducting various demonstration experiments to show the behaviour and properties of transverse waves. The motion of the wave is demonstrated by a chain of 73 steel pendulum bars each soldered at their mid-point along a rod spring that can be subjected to torsion. The ends of the bars are painted on one side in fluorescent paint and on the other side with white paint. The machine is mounted on a foldable steel base. A damping mechanism is also supplied and a retaining clamp on a stem for demonstrating reflections at a fixed end.

Number of bars: 73
 Length of bars: 460 mm
 Total length: 920 mm

P-1003492

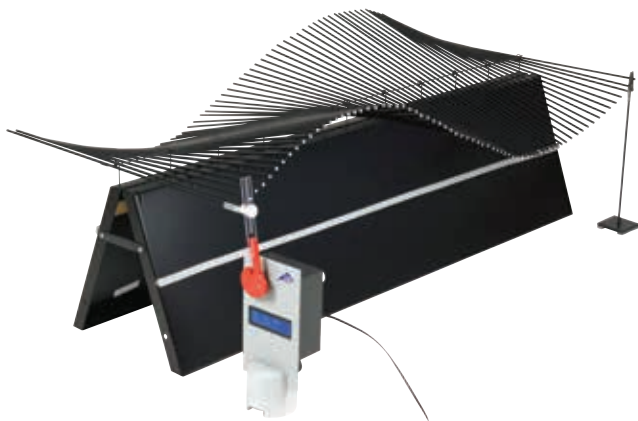

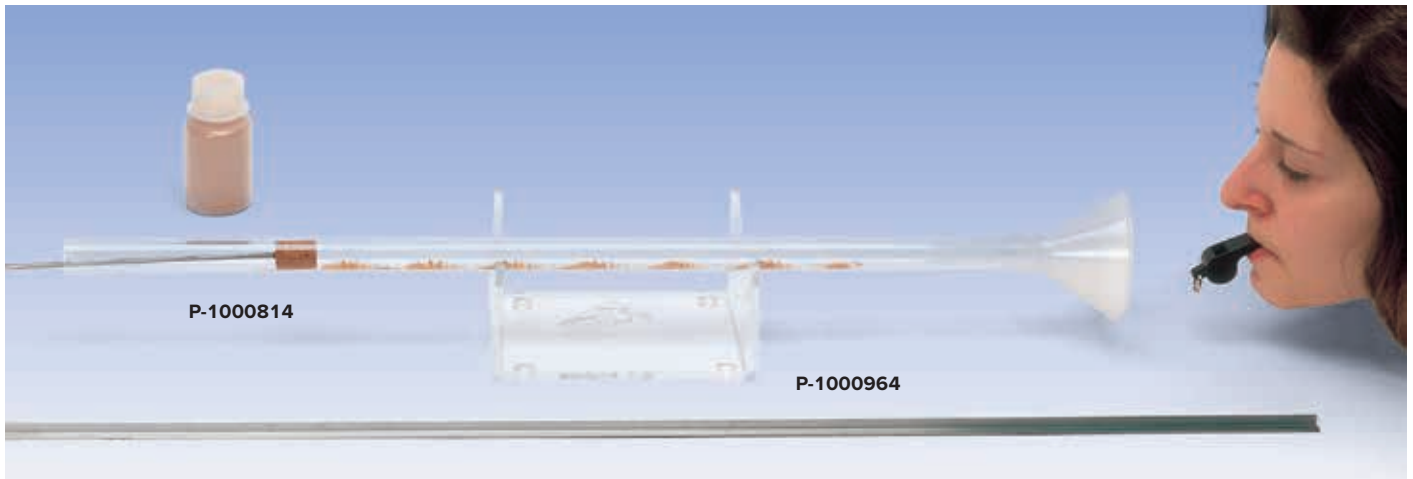

Kundt's Tube

Glass tube for demonstrating standing sound waves and calculating wavelengths of sound using cork powder in a method devised by Kundt. Cork powder is spread evenly throughout the tube by means of a filler chute. Then a sound source, e.g. a whistle, a 1700 Hz tuning fork (P-1002607) or a horn speaker (P-1000811), is used to excite the powder into a regular pattern of nodes and antinodes. The effective length of the tube can be altered by means of a piston.

Length: 600 mm
 External diameter: 20 mm
 Internal diameter: 17 mm

Contents:

- 1 Glass tube with funnel
- 1 Plunger
- 1 Filler chute
- 1 Whistle
- 1 Bottle of cork powder

P-1000814

Additionally recommended:

P-1000964 Acrylic Stands

Experimental Topics:

- Resonances in an oscillating column of air
- Standing sound waves
- Determination of wavelengths of sound waves in air
- Determination of speed of sound in air

Quincke's Resonance Tube

Quincke's resonance tube is used for demonstrating interference effects in standing sound waves. The equipment set consists of a resonance tube with a millimetre scale which is partially filled with water and is connected to an expansion vessel with a tube. The column of air above the water is excited to oscillate by using a tuning fork (or optionally a loudspeaker). By raising the expansion tank, the level of water inside the tube can be raised as well, which therefore reduces the height of the air column. The sound wave emitted by a sound source above the one open end of the tube is superimposed on the wave reflected from the surface of the water which results in constructive or destructive interference. Audible resonances occur when the length of the oscillating column of air is an odd integer multiple of a quarter wavelength of the sound.

Height of resonance tube: 1 m
 Diameter of resonance tube: 3 cm
 Scale: 98 cm
 Divisions: 1 mm
 Height of expansion vessel: 24 cm
 Diameter of expansion vessel: 7 cm
 Weight (without accessories and stands): approx. 3.3 kg

Contents:

- 1 Resonance tube with scale
- 1 Expansion vessel
- 1 Silicone tube
- 2 Horizontal clamps
- 1 Standard tuning fork, $a^1 = 440$ Hz
- 1 Beater

P-1018475

Additionally required:

- P-1002936 Stainless Steel Rod, 1000 mm**
- P-1001044 Stand Base, A-Shaped, 200 mm**
- P-1002830 Universal Clamp**



Cork Powder, 10 g Bottle

Fine cork powder for use in Kundt's glass tube (P-1000814).

P-1000815



Experiments on Sound Waves and the Speed of Sound

Quantitative investigations of standing waves in closed and open tubes – Determination of the speed of sound from wavelength and frequency

Number / Description	Art. No.
1 Kundt's tube E	P-1017339
1 Microphone probe, long	P-1017342
1 Microphone box (230 V, 50/60 Hz)	P-1014520
or	
1 Microphone box (115 V, 50/60 Hz)	P-1014521
1 Function generator FG 100 (230 V, 50/60 Hz)	P-1009957
or	
1 Function generator FG 100 (115 V, 50/60 Hz)	P-1009956
1 Analogue multimeter ESCOLA 30	P-1013526
1 Pair of safety experiment leads	P-1002849
1 HF patch cord, BNC/4-mm plugs	P-1002748

Frequency analysis of standing waves in a closed tube

Number / Description	Art. No.
1 Kundt's tube E	P-1017339
1 Microphone probe, long	P-1017342
1 Microphone box (230 V, 50/60 Hz)	P-1014520
or	
1 Microphone box (115 V, 50/60 Hz)	P-1014521
1 Function generator FG 100 (230 V, 50/60 Hz)	P-1009957
or	
1 Function generator FG 100 (115 V, 50/60 Hz)	P-1009956
1 PC oscilloscope, 2x25 MHz	P-1020857
1 HF patch cord	P-1002746
1 HF patch cord, BNC/4-mm plugs	P-1002748
1 Pair of safety experiment leads	P-1002849

Determination of the time it takes for sound pulses to travel given distances in an enclosed space

Number / Description	Art. No.
1 Microphone probe, short	P-4008308
1 Microphone box (230 V, 50/60 Hz)	P-1014520
or	
1 Microphone box (115 V, 50/60 Hz)	P-1014521
1 Microsecond counter (230 V, 50/60 Hz)	P-1017333
or	
1 Microsecond counter (115 V, 50/60 Hz)	P-1017334
1 Connecting lead with two metal rods	P-1017344
1 Pocket measuring tape, 2 m	P-1002603
1 HF patch cord, BNC/4-mm plugs	P-1002748

Determination of the speed of sound by measuring the time it takes for a sound pulse to cover a given distance in air and in other gases

Number / Description	Art. No.
1 Kundt's tube E	P-1017339
1 Pulse box K	P-1017341
1 Microphone probe, long	P-1017342
1 Microphone probe, short	P-4008308
1 Microphone box (230 V, 50/60 Hz)	P-1014520
or	
1 Microphone box (115 V, 50/60 Hz)	P-1014521
1 Microsecond counter (230 V, 50/60 Hz)	P-1017333
or	
1 Microsecond counter (115 V, 50/60 Hz)	P-1017334
2 HF patch cords, BNC/4-mm plugs	P-1002748
1 Pair of safety experiment leads	P-1002849
A variety of technical gases, if required	

Determine the speed of sound by measuring the time it takes for a sound pulse to cover a given distance as a function of temperature

Number / Description	Art. No.
1 Kundt's tube E	P-1017339
1 Pulse box K	P-1017341
1 Microphone probe, long	P-1017342
1 Microphone probe, short	P-4008308
1 Microphone box (230 V, 50/60 Hz)	P-1014520
or	
1 Microphone box (115 V, 50/60 Hz)	P-1014521
1 Microsecond counter (230 V, 50/60 Hz)	P-1017333
or	
1 Microsecond counter (115 V, 50/60 Hz)	P-1017334
1 Heating rod K	P-1017340
1 DC power supply, 0 – 20 V, 0 – 5 A (230 V, 50/60 Hz)	P-1003312
or	
1 DC power supply, 0 – 20 V, 0 – 5 A (115 V, 50/60 Hz)	P-1003311
1 Digital quick-response pocket thermometer	P-1002803
1 K-Type NiCr-Ni immersion sensor, -65° C to 550° C	P-1002804
2 HF patch cords, BNC/4-mm plugs	P-1002748
2 Pairs of safety experiment leads	P-1002849

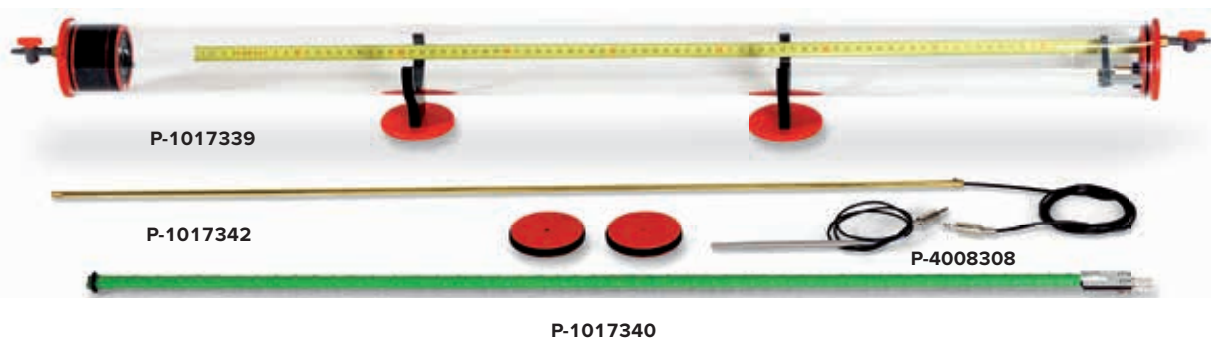

Kundt's Tube E

Sound tube made of transparent acrylic with loudspeaker and movable scale for quantitative investigation of sound waves in air or other gases, in particular for measurement of wavelength and speed of sound. With two stand bases, capillary disc, sensor disc, two hose connectors with stop-cock for filling with gas, fitting and guide for long microphone probe, hole for short microphone probe, plus holder and connector for heating rod K.

Frequency range:	20 to 5000 Hz
Length of sound tube:	1000 mm
Diameter of sound tube:	70 mm
Scale:	950 mm
Hose connectors:	5 mm diameter
Speaker power output:	2 W
Impedance of speaker	50 Ω
Weight:	approx. 1.25 kg

P-1017339

Heating Rod K

Heating rod for warming air in Kundt's tube E up to about 50°C.

Operating voltage:	max. 12 V
Power consumption:	36 W
Temperature in Kundt's tube:	max. 50°C
Connectors:	Pair of 4-mm plugs
Dimensions:	approx. 900 mm x 11 mm diam.

P-1017340

Additionally required:

P-1003312 DC Power Supply, 0 – 20 V, 0 – 5 A (230 V, 50/60 Hz)

or

P-1003311 DC Power Supply, 0 – 20 V, 0 – 5 A (115 V, 50/60 Hz)

Microphone Probe, Long

Miniature microphone at the end of a long rod for measuring changes in sound pressure in Kundt's tube E. With thread for attaching probe disc of Kundt's tube E.

Frequency range:	20 Hz – 16 kHz
Diameter of rod:	6 mm
Length of rod:	810 mm
Connecting lead:	approx. 1 m, with 3.5-mm jack plug

P-1017342

Microphone Probe, Short

Miniature microphone at the end of a short rod for measuring changes in sound pressure.

Frequency range:	20 Hz – 16 kHz, (1 – 20 Hz and 16 – 42 kHz, non-specified tolerance range)
Diameter of rod:	6 mm
Length of rod:	140 mm
Connecting lead:	approx. 0.6 m, with 3.5-mm jack plugs

P-4008308

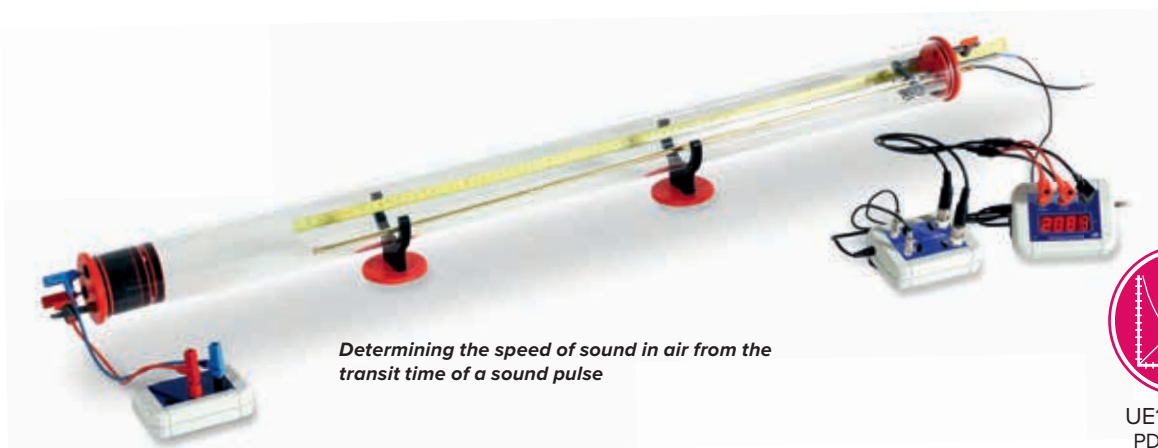

Determining the speed of sound in air from the transit time of a sound pulse



UE1070310
PDF online



Microsecond Counter

Easy to use counter for measuring time in microseconds. Particularly well suited for measurements made in conjunction with the microphone box. Includes 12 V AC plug-in power supply. The counting procedure is started via the Start input and halted by means of the Stop input. Each new start causes the counter to automatically reset to zero. Both inputs respond to a rising edge and are equipped internally with pull-up resistors.

Measuring range	1 – 9999 μ s
Resolution:	1 μ s
Precision:	Quartz precision
Internal resistance:	2.4 k Ω (Start input), 5.6 k Ω (Stop input)
Switching edges for both inputs:	Rising edge
Display:	4-digit LED
Connectors:	4-mm safety sockets
Power supply:	12 V AC, 500 mA plug-in power supply
Dimensions:	approx. 100x75x35 mm ³
Weight:	approx. 400 g including plug-in supply

Microsecond Counter (230 V, 50/60 Hz) P-1017333

Microsecond Counter (115 V, 50/60 Hz) P-1017334



Microphone Box

All-purpose dual-channel amplifier for long or short microphone probes. Particularly suitable for use with microsecond counters in experiments for determining speed of sound, including 12 V AC plug-in power supply. Both channels can be individually switched between the operating modes, "Signal" for connecting an oscilloscope, "Level" for connecting a voltmeters and "Pulse" for connecting a microsecond counter. The trigger threshold for the pulse depends on the gain of the pre-amp, which is adjustable.

Band width:	10 Hz to 42 kHz
Gain:	20 to 70x
Output impedance:	1 k Ω
Output signal:	Switchable between Signal, Level and Pulse
Signal:	0 – 14 V _{pp}
Level:	0 – 7 V DC
Pulse:	Low: 0 V, high: 8 V DC, length: 150 ms
Inputs:	3.5 mm jack plugs
Outputs:	BNC socket
Power supply:	Via 12 V AC, 500 mA plug-in power supply
Dimensions:	approx. 100x75x35 mm ³
Weight:	approx. 450 g including plug-in supply

Microphone Box (230 V, 50/60 Hz) P-1014520

Microphone Box (115 V, 50/60 Hz) P-1014521

Additionally required:

P-1017342 Microphone Probe, Long
or
P-4008308 Microphone Probe, Long



Connecting Lead with Two Metal Rods

Pair of metal rods with a connecting lead for use with the microphone box in order to start measurements of time for the sound pulses in free space.

Length of lead:	75 cm
Connectors:	2x 4-mm safety plugs, 3.5-mm-jack plug
Rods:	110 mm x 10 mm diam.

P-1017344



Pulse Box K

Electronic switch which outputs an electrical pulse to a connected speaker at the press of a button. Power supplied via 9 V block battery.

Dimensions:	approx. 100x75x35 mm ³
-------------	-----------------------------------

P-1017341

Experiment Topics:

- Speed of propagation of sound pulses in various rods
- Comparison between the propagation of longitudinal and transverse waves
- Standing sound waves in short rods
- Polarity of reflections at the ends of the rods
- Multiple reflection at the ends of longer rods



Advantages

- Compact set-up on lab benches
- Non-contact and low-attenuation measurement of sound waves

Equipment Set “Sound Propagation in Rods”

Equipment set for investigating propagation of sound and determining the speed of sound in solid rods of various materials. The set includes various test rods, two microphone probes and a microphone box for connection to an oscilloscope. Contained in a sturdy plastic case with foam inlays in the shape of the apparatus and a transparent lid.

Contents:

- 6 Test rods, 200 mm, made of glass, transparent acrylic (perspex), PVC, wood (beech), stainless steel and aluminium
- 4 Test rods, 100 mm, made of copper, brass, stainless steel and aluminium
- 1 Test rod, 400 mm made of stainless steel
- 2 Beaters
- 2 Microphone probes
- 1 Microphone boxes
- 1 Plug-in power supply 12 V AC
- 3 Rubber mats, 50x40x5 mm³



UE1070410
PDF online



Equipment Set “Sound Propagation in Rods” (230 V, 50/60 Hz)
P-1018469

Equipment Set “Sound Propagation in Rods” (115 V, 50/60 Hz)
P-1018468

Additionally required:

- Dual-channel oscilloscope, e.g.
- P-1020857 PC Oscilloscope, 2x25 MHz

Experiment Topics:

- Directions of sound
- Determining differences in time for sound to propagate to left and right ears
- Effect of linear distortions on cavity resonance



Determining differences in time for sound to travel to right and left ears

Equipment Set “Stereophonic Hearing”

Equipment set for investigation of directionality of sound and determining differences in time for sound to propagate to left and right ears by generation of knocking sounds in a closed tube. The effect of linear distortions on the directionality of cavity resonance can also be investigated by dipping two ends of a tube, at the same time or in alternation, into a beaker which is either empty or half-filled with water. The set consists of a stethoscope with various tubes and a plastic beaker in a rugged plastic case with foam inlays in the shape of the apparatus and a transparent lid.

Contents:

- 1 Stethoscope
 - 2 Spare earpieces
 - 1 Tube, 1 m
 - 2 Tubes, 0.5 m
 - 2 Toothpicks
 - 1 Plastic beaker
 - 1 Storage case
- P-1018551

Additionally recommended:

- P-4008308 Microphone Probe, Short (2x)
- P-1014520 Microphone Box (230 V, 50/60 Hz)
- or
- P-1014521 Microphone Box (115 V, 50/60 Hz)
- P-1017333 Microsecond Counter (230 V, 50/60 Hz)
- or
- P-1017334 Microsecond Counter (115 V, 50/60 Hz)
- P-1002748 HF Patch Cord, BNC/4-mm Plug (2x)



Tuning Fork, 440 Hz, on Resonance Box

Long-sustain tuning fork mounted on a resonant chamber made of clear grained fir wood. Removable, includes a soft striking hammer (P-1002614).

Natural frequency: 440 Hz
 Length of the tuning fork: approx. 170 mm
 Resonance box: 180x90x50 mm³

P-1002613

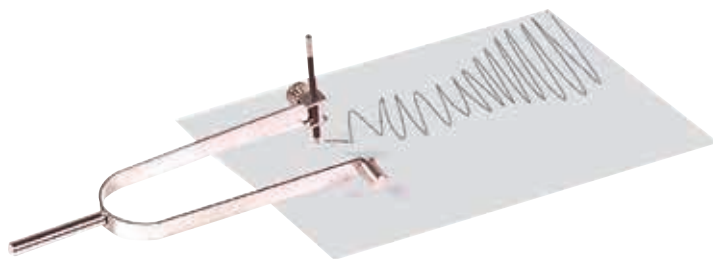

21 Hz Tuning Fork with Plotter Pen

Tuning fork that allows for plotting oscillations on a sheet of paper. The oscillation is triggered by pushing the prongs of the fork together. The oscillation of the tuning fork is highly visible both with the naked eye or with the aid of a stroboscope. Includes a plotter pen with holder and a counterweight.

Natural frequency: 21 Hz
 Length: 245 mm
 Total weight: approx. 170 g

P-1000805

Demonstration Tuning Fork

Large tuning fork for demonstrating the vibrating legs of the fork.

Length: 750 mm

P-1000700



Tuning Fork, 2000 Hz

Tuning fork with handle for demonstrating the Doppler Effect. The effect can be exhibited very impressively by moving the fork slowly toward and away from the audience.

Natural frequency: 2000 Hz
 Length of the tuning fork: 220 mm

P-1002609

Additionally recommended:

P-1002610 Hard Striking Hammer



Recording Tuning Fork, c 128 Hz

For demonstrating and recording sound oscillations. For recording the oscillations on a sooted glass plate one of the two prongs is equipped with a metal tip. Complete with a glass plate.

Natural frequency: 128 Hz
 Total length: approx. 280 mm
 Glass plate: 120x50 mm²

P-1002606



Light Metal Tuning Fork, 1700 Hz

Suitable as a source of intense, high-frequency sound, for example, for producing stationary sound waves in Kundt's tube.

Natural frequency: 1700 Hz
 Length: approx. 105 mm

P-1002607

Light Metal Tuning Fork, 1000 Hz

Suitable as a source of intense, high-frequency sound, for example, for producing stationary sound waves in Kundt's tube.

Natural frequency: 1000 Hz
 Length: approx. 115 mm

P-1002608





Set of Tuning Forks, C-Major Chord, on Resonance Boxes

Set of four tuning forks for demonstrating C major chord. Supplied on a sound box made of clear grained pine for especially long sustain from which the tuning forks can be removed. Includes a soft striking hammer (P-1002610).

Natural frequency:	Internal length:
c' = 256 Hz	300 mm
e' = 322 Hz	240 mm
g' = 384 Hz	190 mm
c'' = 512 Hz	140 mm

P-1002615



Set of Tuning Forks for the C-Major Scale

Set of 8 tuning forks in a storage case.

Frequencies:	
c' = 256 Hz	g' = 384 Hz
d' = 288 Hz	a' = 426 2/3 Hz
e' = 320 Hz	h' = 480 Hz
f' = 341 1/3 Hz	c'' = 512 Hz

P-1002605

Pair of Tuning Weights (not shown)

Two tuning weights for changing the frequency of tuning forks for beat experiments; intended for the 440-Hz tuning fork mounted on a resonance box (P-1002613).

P-1002611



Pair of Tuning Forks, 440 Hz, on Resonance Boxes

Pair of Tuning Forks for experiments on beats; the tuning forks are identical with P-1002613. Complete with a soft striking hammer P-(1002614) and a pair of tuning weights (P-1002611).

P-1002612

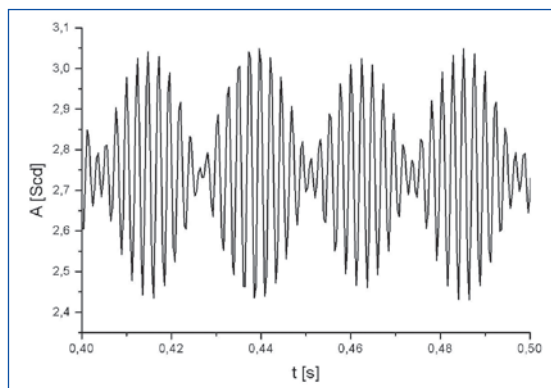

Acoustic beats

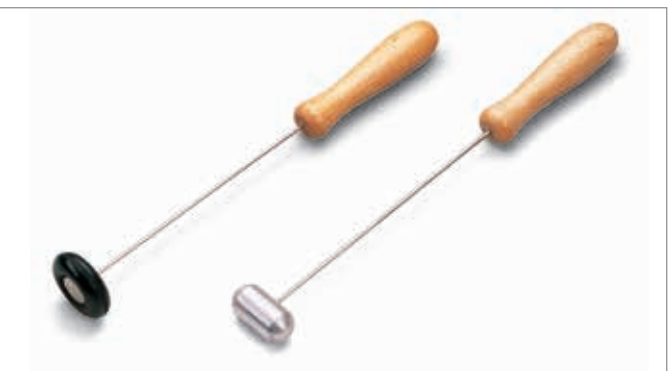

Striking Hammer, Soft

Rubber beater particularly suited for striking low-frequency tuning forks, e.g. tuning forks on sound box (P-1002612, P-1002613 and P-1002615).

P-1002614

Striking Hammer, Hard

Aluminium beater particularly suited for striking high-frequency 2000 Hz tuning fork (1002609).

P-1002610

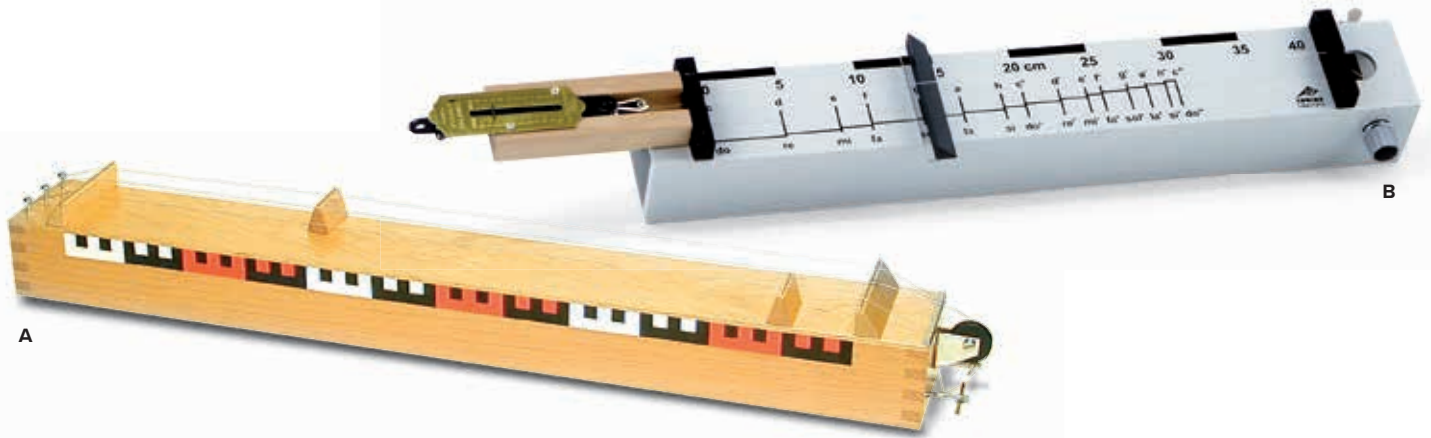

A. Monochord D

Demonstration apparatus for investigating the relationship between the pitch of a sound and the length of the string making it. Also for investigating overtones formed by harmonic waves with intermediate nodes and the dependence of the pitch on string tension. Two steel strings and one nylon string are stretched over a sound box. The tension on two of the strings can be altered by tuning pegs while the other's tension can be changed by adding weights or using a dynamometer at the end of a cord passed over a pulley. The effective length of the strings can be altered by means of two moving bridges.

Scale length: 600 mm
 Scale division: cm and dm
 Dimensions of the resonance box: approx. 700x90x70 mm³
P-1002959

Additionally recommended:

P-1003375 Dynamometer 50 N

Set of 3 Monochord Strings (not shown)

Two steel and one nylon string with eyelets, fitting the monochord D (P-1002959).

P-1002960

B. Monochord

A wooden box open at both ends, with a clamping mechanism for a string to demonstrate the relationship between pitch and string length and the dependence of pitch on string tension. Includes an indicator for the tensioning force, as well as a steel string (tuned to B) and a nylon string.

Dimensions: approx. 490x70x60 mm³
P-1000806



Lip Whistle

Lip whistle for experiments on pitch as a function of resonance space. Closed wooden whistle with a round cross-section and movable piston, chromatic range from g^1 (392 Hz) to g^2 (794 Hz).

Frequency range: approx. 400 Hz – 800 Hz
 Resonance space: approx. 170 mm x 20 mm diam.
 Length: approx. 250 mm

P-1009924

Helmholtz Resonator

Hollow glass bulb with a narrow tube leading out for demonstrating acoustic resonance. The fundamental oscillation is generated by blowing into the opening or tapping on the outside of the bulb. The elasticity and inertial mass of the air in the bulb cause the bulb to act as an acoustic resonator with a highly distinct resonant frequency. The frequency is dependent on the dimensions of the bulb and the tube. With a whole set of Helmholtz resonators it is possible to demonstrate how tones combine to form a tonal mixture.

Opening on the glass bulb: 14 mm diam.
 Length of tube: 15 mm
 Internal diameter of tube: 6 mm

Helmholtz Resonator, 70 mm diam.
P-1003520

Helmholtz Resonator, 52 mm diam.
P-1003521

Helmholtz Resonator, 40 mm diam.
P-1003522

Helmholtz Resonator, 34 mm diam.
P-1003523



Metallophone

Metallophone for demonstrating a C major scale from c^1 to g^2 . Note labels, frequencies and frequency ratios are printed on the instrument. With striking hammer.

Dimensions: approx. 320x210 mm²
 Weight: approx. 510 g

P-1000804

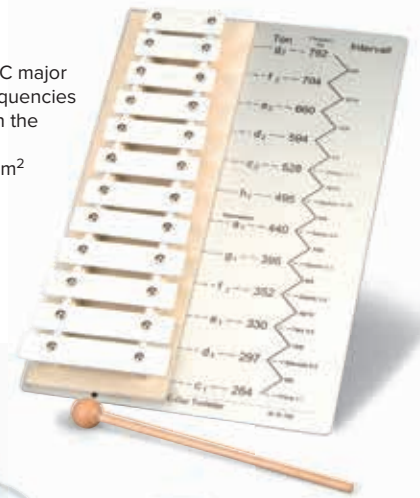

Horn Speaker

Speaker that approximates to being a point source for excitation of Kundt's tube (P-1000814), for example.

Frequency range: 100 Hz - 20 kHz

Max. load capacity: 10 W

Impedance: 8 Ω

Shaft: 10 mm diam.

Dimensions: approx. 100x135x80 mm³

Weight: approx. 650 g

P-1000811

Additionally recommended:

P-1009957 Function Generator FG100 (230 V, 50/60 Hz)

or

P-1009956 Function Generator FG100 (115 V, 50/60 Hz)



Wide-Band Loudspeaker

Ideal sound source for acoustics experiments in the frequency range 60 Hz to 23 kHz. Includes connecting lead with 4 mm safety plugs.

Frequency range: 60 Hz to 23 kHz (-10 dB)

Power capacity: 100 W (as per IEC 268-5)

Impedance: 4 Ω

Tweeter: 1/2" diam.

Woofers: 5 1/2" diam.

Dimensions: approx. 225x150x142 mm³

Weight: approx. 1.8 kg

P-1000812

Additionally recommended:

P-1009957 Function Generator FG100 (230 V, 50/60 Hz)

or

P-1009956 Function Generator FG100 (115 V, 50/60 Hz)



Recording of ultrasonic standing waves

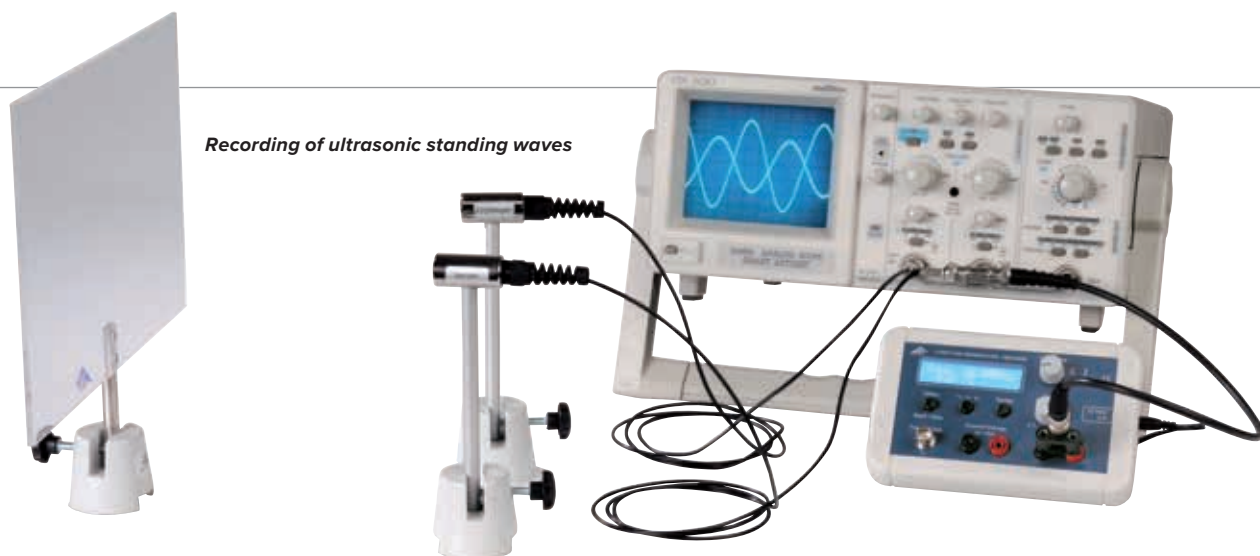

Ultrasound Transducer, 40 kHz, Equipment Kit

Equipment set for experiments on geometric and wave-mechanical acoustics. Based on the piezo-effect discovered by the Curie brothers, an AC voltage is applied to a piezo-electric body causing it to oscillate. Sound waves can also be used to excite the body and the oscillations can be converted into an electrical voltage signal.

Resonant frequency: 40 kHz approx.

Band width: 6 kHz approx.

Capacitance: 1900 pF

Connector: BNC

Stand rod: 150 mm x 10 mm diam.

Dimensions: 40 mm x 20 mm diam.

Contents:

1 Ultrasonic transmitter, on stand rod

1 Ultrasonic receiver, on stand rod

1 Projection screen

1 Ruler, 1 m

P-1009888

Equipment:

P-1009888 Ultrasound Transducer, 40 kHz, Equipment Kit

P-1009957 Function Generator FG100 (230 V, 50/60 Hz)

or

P-1009956 Function Generator FG100 (115 V, 50/60 Hz)

P-1020910 Digital Oscilloscope 2x30 MHz

P-1001046 Barrel Foot, 0.5 kg (3x)

P-1002746 HF Cable

P-1002752 T-Piece, BNC

P-1002751 Adapter, BNC Jack/4-mm-Plugs



Debye-Sears Effect

In 1932, Debye and Sears for the first time demonstrated the refraction of light as it passed through a liquid being subjected to high-frequency vibrations. In this process, the density maxima and minima of a stationary ultrasonic wave act like the elements of an optical diffraction grating. The grating constant here is equal to half the wavelength and therefore dependent on the frequency and speed of the ultrasonic waves transmitted through the medium (e.g. water, glycerin, oil).

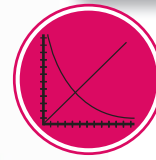
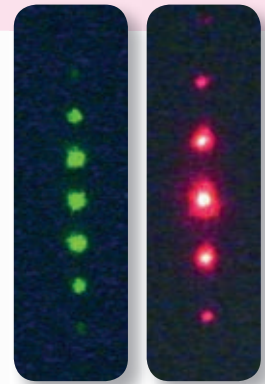

Equipment for the Debye-Sears Effect:
P-1002576 Ultrasonic CW Generator with Probe
P-1002578 Test Vessel
P-1002577 Laser Diode for the Debye-Sears Effect, red
P-1002579 Laser Diode for the Debye-Sears Effect, green

UE1070550
 PDF ONLINE

Ultrasonic cw Generator with Probe

Ultrasonic generator for producing continuous, high-powered ultrasonic waves in a wide frequency range of up to 20 MHz. Includes a multi-frequency probe with waterproof cast sound transmitting surface. The transmitter frequency can be adjusted in digital increments of 1 Hz and is indicated on a display. The acoustic power can also be adjusted by regulating the transmitter voltage of the ultrasonic converter and can be turned on and off separately. The transmitting mode is shown by an indicator lamp. The transmitter voltage is shown on an LCD display. The transmitter output supplies a sinusoidal signal with a maximum amplitude of 46 Vpp. In addition, the transmission frequency is output in the form of a TTL signal via a BNC socket and as a generator signal (max. 2.5 Vpp) via another BNC socket. The equipment can therefore be used as a flexible signal generator.

There is also a suitable voltage output for controlling the red and green laser diodes in the Debye-Sears experiment. This, too, can be turned on and off separately and has its own indicator light.

Generator frequency: ≤ 20 MHz
 Multi-frequency probe: 1 – 13 MHz
 Frequency increment: 1 Hz
 Signal amplitude: 2 – 46 Vpp
 Transmitted signal output: Continuous wave/burst/pulse signal, separately switchable with indicator light
 TTL output: 0 – 5 V, square signal
 Signal generator output: Sine, triangle, square with continuous wave, burst or pulse signal, max. 2.5 Vpp
 Connection: Laser diode, adjustable, separately switchable with indicator light
 Display: Current, voltage and frequency (continuous wave, burst, pulse) or alternatively laser voltage, signal generator voltage and signal type (sine, triangle, square), burst length and pulse repeat frequency
 Mains voltage: 100 – 240 V, 50/60 Hz
 Dimensions: approx. 255x170x265 mm³

P-1002576

Test Vessel, Complete

Test vessel made of glass, for conducting the Debye-Sears experiment or projecting ultrasonic waves with divergent light. Lid with probe adjustment via three adjustment screws can be used to produce a stationary wave.

A laser fixture with a lens mounting aligned vertically to the sound axis. Includes a plano-convex lens on a square mounting for the projection.

Test vessel: 100x100x120 mm³
 Testing volume: approx. 1 litre
 Laser fixture: 18 mm diam.
 Lens: Plano-convex, f = 100 mm, 16 mm diam.

P-1002578

Laser Diode for Debye-Sears Effect, Red

Laser diode of protection classification II with 1 m connector lead and barrel connector for connecting ultrasonic cw generator (P-1002576). Fits the laser holder of test vessel (P-1002578). All lasers have been measured to determine their wavelength specifically and the results are logged.

Wavelength: approx. 650 nm
 Power: < 1 mW
 Supply voltage: 3 V DC
 Current consumption: max. 30 mA
 Dimensions: 90 mm x 17 mm diam.

P-1002577

Laser Diode for Debye-Sears Effect, Green

Laser diode of protection classification IIIa with 1 m connector lead and barrel connector for connecting ultrasonic cw generator (1002576). Fits the laser holder of test vessel (1002578). All lasers have been measured to determine their wavelength specifically and the results are logged.

Wavelength: approx. 532 nm
 Power: < 5 mW
 Supply voltage: 3 V DC
 Current consumption: max. 250 mA
 Dimensions: 90 mm x 17 mm diam.

P-1002579

Ultrasonic Echoscope GS200

Operational device for conducting ultrasonic experiments in reflection mode (pulse echo) or in through-transmission mode with ultrasonic probes 1 MHz (P-1018617), 2 MHz (P-1018618) and 4 MHz (P-1018619). With the built-in transmission and receiving unit, time gain control (TGC), integrated analogue-digital converter and microprocessor for connection to the measuring and evaluating computer via the USB interface. Connection of the ultrasonic probes via robust strain sockets with automatic probe recognition.

Compensation for losses of intensity in ultrasonic sound pulses passing through solid or liquid bodies by means of TGC with selectable threshold, start point, end point and TGC ramp. The most important function signals (trigger, TGC, A-scan signal (amplitude signal) and ultrasound signal) are available via BNC sockets on the front of the device. Includes measurement and evaluation software for Windows operating systems. Screen display of the ultrasound signals (echogram) and the simultaneous TGC signal, whereby the A-scan signal and ultrasound signal can be recorded individually or both simultaneously in the echogram as a function of time or penetration depth. Display of all currently set system parameters (operating mode, transmission level, gain, connected ultrasound probes) calculation of frequency and cepstrum of ultrasound signal (FFT), depiction of 2-dimensional ultrasonic images (B-image) and the time characteristic of time motion reflection layers (time-motion methods). Ultrasonic probes not included in scope of delivery.

Frequency range: 1 – 5 MHz
 Transmission signal: Dirac pulse ($< 1 \mu\text{s}$, 0 – 300 V)
 Transmission power: 0–30 dB, in 5 dB steps
 Gain: 0–35 dB, in 5 dB steps
 TGC: Continuously adjustable threshold value, start value, rise time and gain time, Maximum gain of approx. 32 dB

Outputs (front): TGC, trigger, ultrasound signal, A-scan signal via a BNC socket in each case

Probes connectors: 2, selectable for transmit, receive or duplex modes

PC connection: USB

Scanning rate: 10, 25, 50 and 100 MHz

Power consumption: approx. 20 VA

Mains voltage: 100 – 240 V, 50/60 Hz

Dimensions: approx. 226x169x325 mm³

P-1018616

Experiment Topics:

- Propagation of longitudinal and transverse ultrasonic waves in solid bodies
- Determining velocity of longitudinal and transverse ultrasonic waves in solid bodies
- Determination of shear modulus, modulus of elasticity and Poisson number
- Attenuation of sound in solid bodies and liquids
- Frequency dependence of sound attenuation
- Time-dependent gain
- Frequency dependence of resolution
- Recording brightness images
- Recording ultrasonic echoes from moving boundaries (time-motion mode)
- Measurement of anomalies

Equipment:

P-1018616 Ultrasonic Echoscope GS200

P-1002584 Equipment Set "Ultrasound in Solids"

P-1018617 Ultrasonic Probe 1 MHz, GS200 (2x)

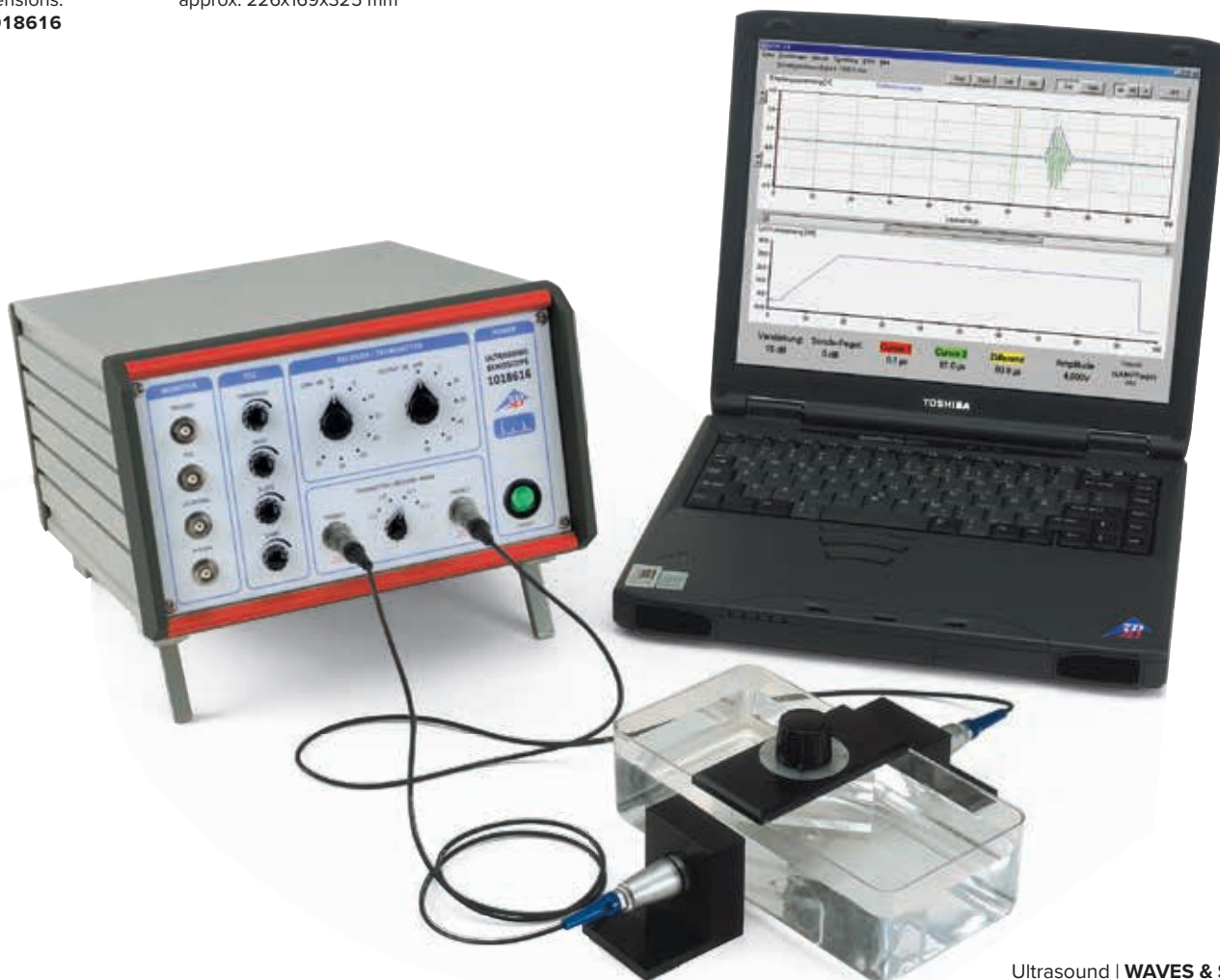

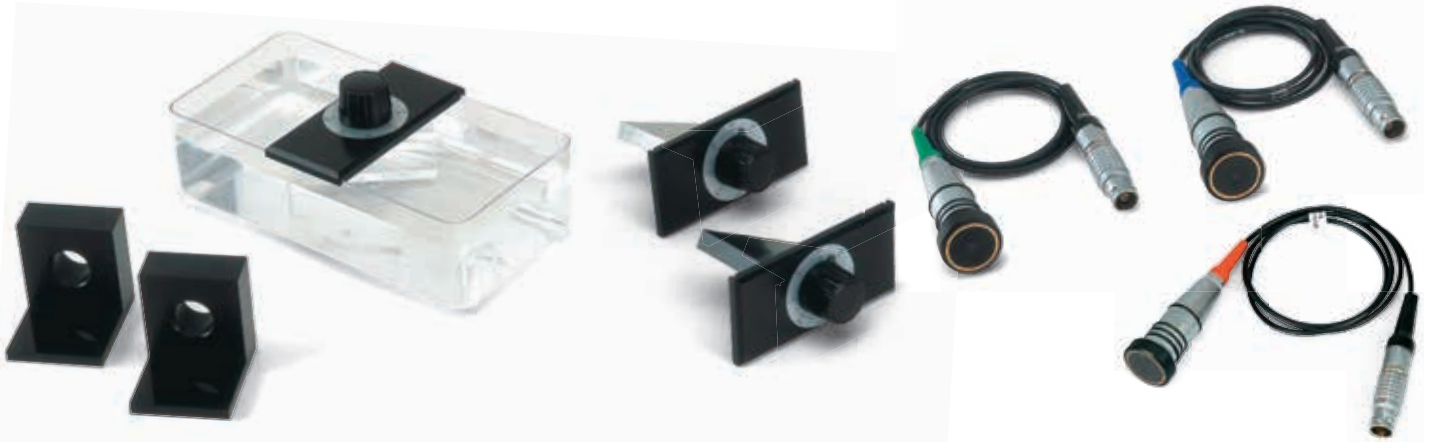

Ultrasonic Probe 1 MHz, GS200

Ultrasonic probe for tests involving large penetration depths or high acoustic power at low depth resolutions. It includes a 16-mm piezo-ceramic disc in a die-cast metal case and a 1-m long cable with a frequency-coded snain plug. The equipment is adapted to sound in water/acrylic glass.

Dimensions: 65 mm x 27 mm diam.

For use with ultrasonic echoscope GS200

P-1018617

Ultrasonic Probe 2 MHz, GS200

Ultrasonic probe for investigations at medium penetration levels and depth resolution. It includes a 16-mm piezo-ceramic disc in a die-cast metal case, adapted to sound in water/acrylic glass, a 1 m long cable with a frequency-coded snain plug.

Dimensions: 65 mm x 27 mm diam.

For use with ultrasonic echoscope GS200

P-1018618

Ultrasonic Probe 4 MHz, GS 200

Ultrasonic probe for investigations with small penetration depths and maximum depth resolution. It includes a 16-mm piezo-ceramic disc in a die-cast metal case and a 1 m long cable with a frequency-coded snain plug. The equipment is adapted to sound in water/acrylic glass.

Dimensions: 65 mm x 27 mm diam.

For use with ultrasonic echoscope GS200

P-1018619

Equipment Set "Ultrasound in Solids"

Equipment kit for the investigation of the propagation of longitudinal and transversal waves (shear waves) as well as for the determination of elastic constants (shear modulus, elasticity modulus and Poisson's ratio) in solid bodies. Further for the determination of ultrasonic attenuation in liquids by means of time dependent amplitude measurement with sliding reflector (P-1002585). Consisting of acoustic basin, polyacrylic test plate in holder with protractor scale and two probe holders to accommodate and precisely position two 1 MHz (P-1018617), 2 MHz (P-1018618) or 4 MHz (P-1018619) ultrasonic probes on the acoustic basin.

Sound trough: 200x100x60 mm³

Test plate: 104x75x50mm³

Protractor scale: 360°, 5° divisions

Polyacrylate block: 70x45x10 mm³

P-1002584

Additionally recommended:

P-1002585 Aluminium Test Block with Protractor Scale

P-1002586 Polyoxymethylene Test Block with Protractor Scale

Pair of Reflection Blocks with Delay Line

These polished polyacrylate blocks are used to investigate multiple echoes and measure frequency-dependent attenuation. A 4 MHz probe (P-1018619) is especially suitable for such measurements. An echo pattern comprising at least 3 echoes is recorded, and the spectra of the individual echoes analysed. The result of the analysis is a shift in the average frequency toward lower frequencies, due to a stronger attenuation of the signal's high-frequency components.

Dimensions: 80x40x10 mm³

P-1002587

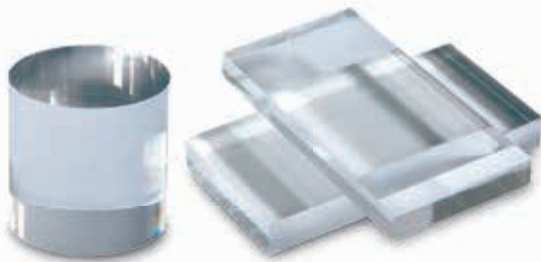

Aluminium Test Block with Protractor Scale

This accessory to equipment set 1002584 for longitudinal and transverse waves is used to examine the propagation of transverse waves in metals and ascertain the elastic constants of aluminium, such as its shear modulus, modulus of elasticity and Poisson ratio. The test block's very high reflectivity with high reflection coefficient in water provides sizeable signal amplitudes for measurements of attenuation in liquids (e.g. water, cooking oil or glycerine).

Protractor scale: 360°, 5° divisions

Aluminium block: 70x45x10 mm³

Dimensions: 104x75x50 mm³

P-1002585

Polyoxymethylene Test Block with Protractor Scale

This accessory to equipment set P-1002584 for longitudinal and transverse waves is used to examine the propagation of transverse waves in plastic and ascertain the elastic constants of polyoxymethylene (POM) such as its shear modulus, modulus of elasticity and Poisson ratio.

Protractor scale: 360°, 5° divisions

POM block: 70x45x10 mm³

Dimensions: 104x75x50 mm³

P-1002586

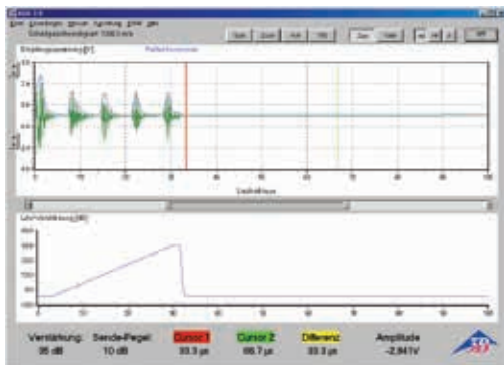

Multiple reflections from a mirror plate

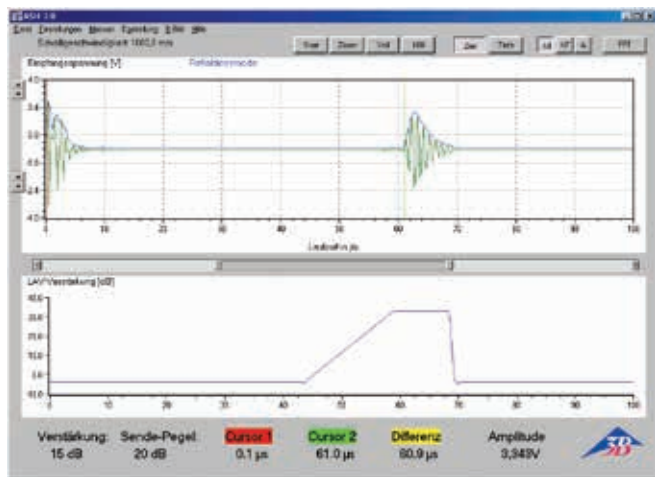

Pulse echo signal from a hole

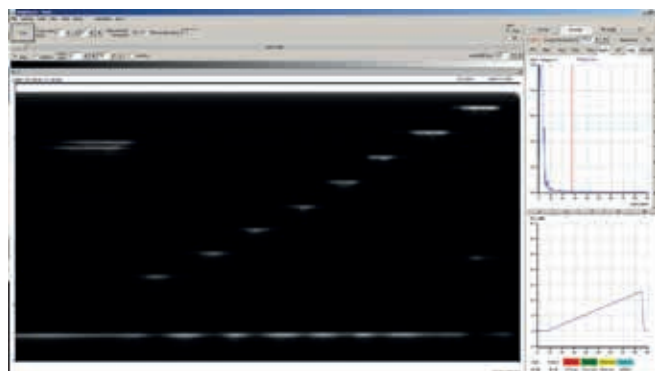

B-image: acrylic body with drilled holes

Heart Model

This double vessel with a rubber membrane and pressure regulator is used to demonstrate movement of the cardiac wall by means of the time-motion technique. In the experiment the membrane vessel produces images similar to the cardiac wall of a beating heart during echocardiography in medical diagnostics.

Dimensions: 160x70 mm²

P-1002590

Additionally required:

- P-1018616 Ultrasonic Echoscope GS200
- P-1018619 Ultrasonic Probe 4 MHz, GS200
- P-1008575 Ultrasonic Coupling Gel

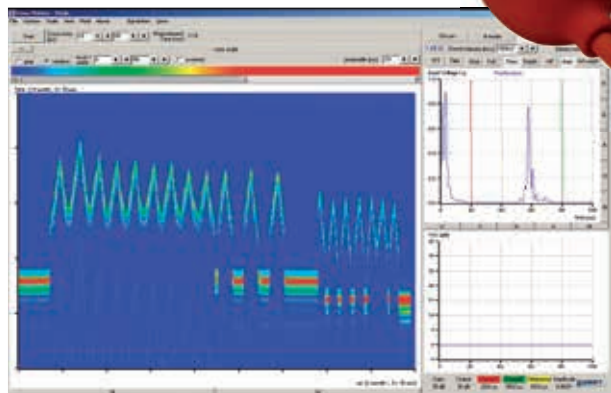

Time motion scan



Acrylic Body with Drilled Holes

Polished polyacrylic block with bores of various diameters and varying distance from the surface to determine the speed of sound and the attenuation of ultrasonic signals in polyacrylate, to localise defects, investigate aberrations resulting from acoustic shadows and ground returns, analyse frequency-dependent resolving power and display manual B-images.

Dimensions: 150x80x40 mm³

P-1002589

Additionally required:

- P-1018616 Ultrasonic Echoscope GS200
- P-1018617 Ultrasonic Probe 1 MHz, GS200
- P-1018619 Ultrasonic Probe 4 MHz, GS200
- P-1008575 Ultrasonic Coupling Gel

Set of 3 Cylinders

These polished polyacrylate cylinders are used to ascertain the speed of sound and the attenuation of ultrasonic waves in transparent acrylic. Measurements can be performed in reflection mode or through-transmission mode.

Length : 40 mm, 80 mm and 120 mm
Diameter: 40 mm

P-1002588



Model Eye for Ultrasonic Biometry

Model of the human eye, enlarged to a scale of 3 to 1, including the cornea, the lens and glass bodies for demonstrating the fundamentals of ultrasonic biometry. The biometric ratios in the human eye (distance between cornea and lens, thickness of lens, distance between lens and retina) are very well suited to demonstrating measurement using a pulse-echo method with ultrasound. With the help of an ultrasonic echoscope GS200 (P-1018616) and a 2-MHz ultrasonic probe (P-1018618), typical echoes and the speed of sound can be measured. This allows the geometry of individual objects in the eye to be calculated. A lesion close to the back of the eye becomes apparent due to the diffuse nature of its echo.

Diameter: 80 mm

P-1012869

Additionally required:

- P-1018616 Ultrasonic Echoscope GS200**
- P-1018618 Ultrasonic Probe 2 MHz, GS200**
- P-1008575 Ultrasonic Coupling Gel**

Recommended for comparison:

P-1000259 Model of the Human Eye, 3 times full-size, 6 part

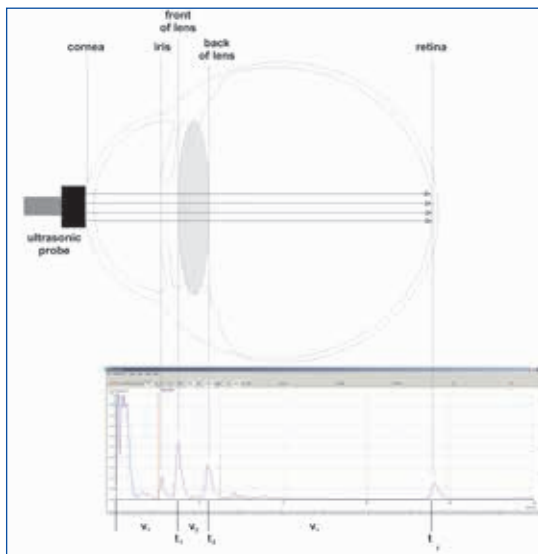

A-mode image and schematic diagram of the human eye



Single Breast Model with Benign Tumour

Model of a woman's breast made of 3B SKINlike™ silicone with simulated benign tumour for the demonstration of ultrasonic B-image mode with Ultrasonic Echoscope GS200 (1018616).

P-1000345

Additionally required:

- P-1018616 Ultrasonic Echoscope GS200**
- P-1018617 Ultrasonic Probe 1 MHz, GS200**
- P-1008575 Ultrasonic Coupling Gel**

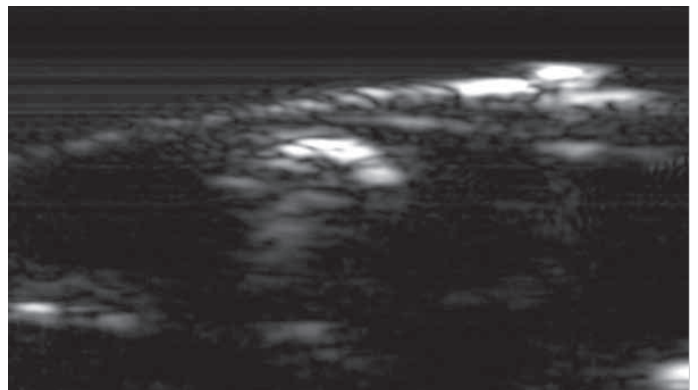

B-image: breast model

Ultrasonic Coupling Gel

To secure the ultrasonic probes to solid test objects.
Contents: 250 ml

P-1008575

Doppler Phantom Fluid

Phantom fluid with excellent scattering characteristics for ultrasonic waves in the frequency range from 1 – 6 MHz and viscosity calibrated for ultrasonic Doppler experiments. In plastic bottle.

Contents: 1 l
Ultrasonic scattering: 1 – 6 MHz
Colour: blue
Diameter of glass microspheres: 30 – 50 µm

P-1002574



Equipment:

- P-1002571 Ultrasonic Doppler Apparatus**
- P-1002582 Ultrasonic Probe 2 MHz**
- P-1002572 Set of Doppler Prisms and Flow Tubes**
- P-1002573 Riser Tubes for Pressure Measurement**
- P-1002574 Doppler Phantom Fluid**
- P-1002575 Centrifugal Pump**
- P-1008575 Ultrasonic Coupling Gel**

Ultrasonic Doppler Apparatus

Ultrasonic device for carrying out experiments on the Doppler principle, on fluid mechanics and on Doppler sonography in the diagnosis of vascular problems. Includes measurement and evaluation software for Windows operating systems in order to display the measured signals and colour-coded Doppler spectra. If the radiated waves are reflected or scattered from moving particles or bubbles in fluid flow, the Doppler shift in frequency can be detected. The equipment detects the scattered waves and generates an audio signal at a volume that reflects the amplitude of the reflected signal and a frequency that reflects the speed of the scattering. At the same time, the amplitude is also displayed on an LED bar display. Sensitivity and volume can be adjusted by means of appropriate controls. The controller can also pass on data to a PC for detailed recording and evaluation. During measurement the current LF Doppler signal is displayed. Evaluation is by means of a Fourier transformation in the frequency domain and the result can be interpreted as the distribution of velocity within the flow.

Frequency: 1 MHz, 2 MHz and 4 MHz
Gain: 10 – 40 dB
Display: LED bar display and acoustic signal with volume control
PC connector: USB
Mains voltage: 90 – 230 V, 50/60 Hz
Dimensions: approx. 256x185x160 mm³

P-1002571

Set of Doppler Prisms and Flow Tubes

Equipment set including plastic tubes and hoses of various diameters for investigating flow phenomena using ultrasonic waves. Includes Doppler prisms for connecting an ultrasonic probe to the tubes or hoses at three different angles.



Contents:

- 1 Doppler prism 1/4"
- 1 Doppler prism 3/8"
- 1 Doppler prism 1/2"
- 1 Flow tube 1/4", 300 mm
- 1 Flow tube 3/8", 300 mm
- 1 Flow tube 1/2", 300 mm
- 1 Hose 1/4", 1000 mm
- 1 Hose 3/8", 3000 mm
- 1 Hose 1/2", 1000 mm
- Various hose connectors, T-pieces and accessories

P-1002572

Riser Tubes for Pressure Measurement

Set of four riser tubes with millimetre scales for measuring the relationship between pressures at up to four measuring locations in a flow circuit. Includes tubing and Luer-Lock connectors for attachment to a flow circuit and stand.

Length: 1000 mm
Connectors: Luer Lock, male
Length of tubing: 1200 mm
Tubing connector: 3/8" female Luer Lock connector

P-1002573



Experiment Topics:

- Investigation of flowing liquids using ultrasonic waves
- Experiments on the Doppler principle
- Measurement of flow velocities
- Demonstration of laminar and turbulent flow
- Experiments on the continuity equation, Bernoulli's equation (static and dynamic pressure) and the Hagen-Poiseuille law (resistance to flow)

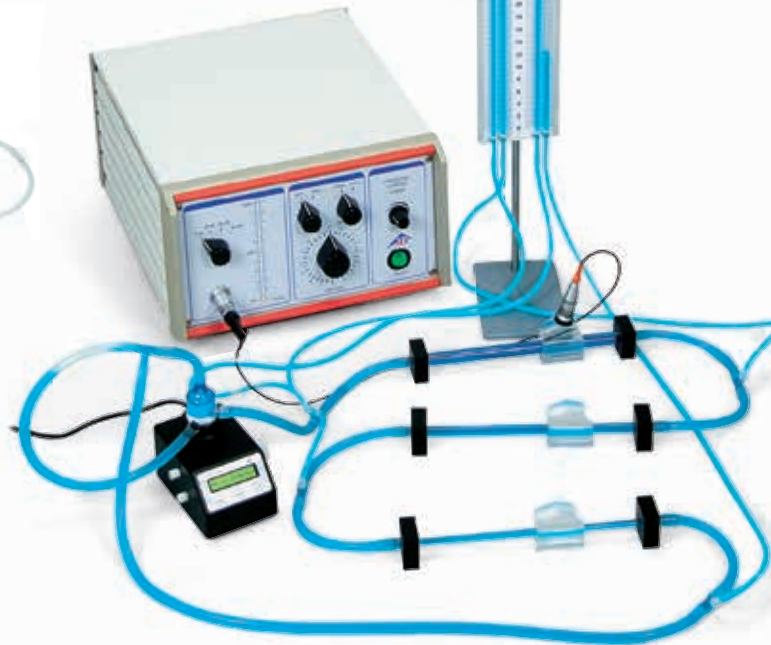
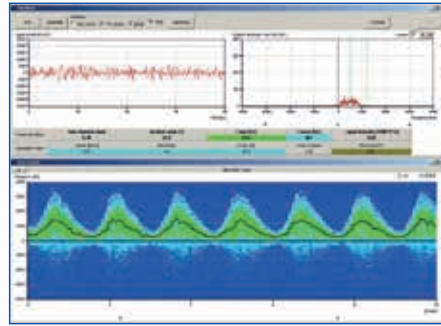

Ultrasonic Probe, 2 MHz

Ultrasonic probe for investigations at medium penetration levels and depth resolution. It includes a 16-mm piezo-ceramic disc in a die-cast metal case, adapted to sound in water/acrylic, a 1-m long cable with a frequency-coded snail plug. Dimensions: 65 mm x 27 mm dia. For use with Ultrasonic Doppler Apparatus

P-1002582





Arm Phantom Set

Model of a human arm for simulating Doppler sonographic examinations of blood vessels. Includes an ultrasonic Doppler probe and so-called phantom fluid for simulating blood. The model features a variety of tubing (simulating blood vessels), including one tube which simulates a blood vessel stricture or stenosis. Using the ultrasonic Doppler apparatus (P-1002571) and a centrifugal pump (P-1002575), it is possible to simulate typical examinations used in vascular diagnosis. Doppler spectra are measured for the flow through arteries and veins with both a pulsing flow (like a heart beat) and continuous flow, allowing sounds typical of Doppler sonography to be heard. One particularly interesting feature is the possibility of observing the change in the spectra and the Doppler sound due a stenosis (stricture) in the elbow. In addition, it is possible to calculate the flow index and resistance index from the curves measured with a pulsing flow.

Probe frequency: 2 MHz
 Probe dimensions: 200 mm x 15 mm diam.
 Length of lead: 1 m

Includes:

- Model arm with stenosis
- Silicone tubing
- 3/8" connectors
- Ultrasonic Doppler probe
- Phantom fluid to simulate blood, 250 ml
- Funnel
- Rubber stoppers

P-1012880

Equipment:

P-1002571 Ultrasonic Doppler Apparatus

P-1002575 Centrifugal Pump

P-1012880 Arm Phantom Set

P-1008575 Ultrasonic Coupling Gel

- Experiment Topics:**
- Doppler sonographic examinations of the human arm
 - Measurement of the flow velocity of blood
 - Recording of Doppler spectra and pulse curves
 - Diagnosis of stenosis (vascular stricture) in an arm

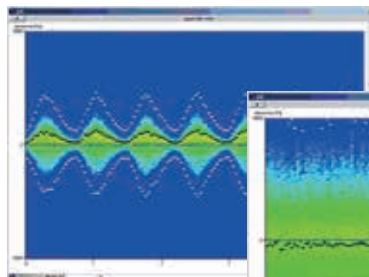

Doppler spectrum of arterial blood flow

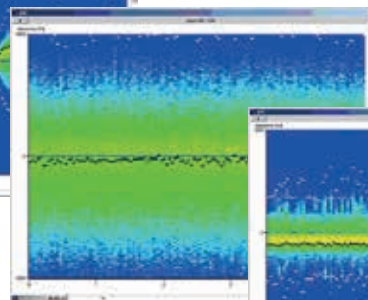

Doppler spectrum of a stenosis (stricture)

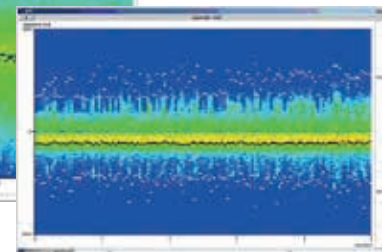

Doppler spectrum of blood flow in veins

Centrifugal Pump

Pump for transporting liquids at a constant flow velocity which can be regulated continuously to any value and intended for the investigation of flow phenomena with laminar flow profiles. The pump has 3/8" plug-in connectors for insertion into a flow circuit (P-1002572) or an arm simulator (P-1012880). The display can be switched to show either speed or flow. The display of the flow can be calibrated to match the flow pressure. For Doppler sonographic experiments using a so-called arm phantom to simulate a real arm, the pump can be set to provide a pulsing flow (to simulate a heart beat) with a variable pulse frequency. This allows ultrasonic signals to be obtained which are typical for vascular diagnosis.

Connectors: 2x 3/8"
 Max. flow: 6 l/min
 Display: LCD
 Mains voltage: 90 – 230 V, 50/60 HZ

P-1002575



Ultrasonic Computer Tomography

In order to control computer tomography by means of a computer, the AScan software supplied with the ultrasonic echoscope is used. It can generate mechanically scanned so-called B scans as well as ultrasonic tomographic images. The CT algorithm is incorporated into the AScan software in the form of a module. Both unfiltered and filtered attenuation and run-time scans, the current A scan, the configuration of the run-time dependent gain and the amplitude of the row scan currently being undertaken are all depicted graphically. In addition, the various scanner positions in millimetres and the current angle of rotation in degrees are displayed. The CT scan (attenuation and run-time scans) is updated after each row is scanned and enhanced step by step so that the emergence of the tomographic image can be understood in its individual stages. The CT and B scans can be exported and printed out. Depending on the time and the object being studied, the number of angular positions and the step range can be specified along with the length of the scan.

Equipment Ultrasonic Computer Tomography

Quantity/Description	Art. No.
1 Ultrasonic echoscope GS200	P-1018616
1 CT scanner	P-1017782
1 CT controller	P-1017783
1 measuring trough	P-1017785
1 CT sample	P-1017784
2 Ultrasonic probes 1 MHz, GS200	P-1018617
1 Ultrasonic probe 2 MHz, GS200	P-1018618



CT Controller

Controller for operating the two stepper motors for the linear motion axis and the rotation axis of the CT scanner. Control of motion or direction of rotation, as well as linear speed and rotational velocity can be set manually or with a PC via a USB connection.

Output: 2 x Stepper motor controllers, bipolar, 5 V, max. 2 A
 Port: USB
 Supply voltage: 100 – 240 V, 50/60 Hz
 Power consumption: max. 50 VA
 Dimensions: 155x170x315 mm³

P-1017783



CT Measuring Trough

Sample trough for CT scanner made of thin transparent plastic. Includes several special fittings for attaching and connecting ultrasonic sensors to the sides of the trough. Since transparent acrylic exhibits a very low acoustic impedance step response as compared to water, reflections are largely eliminated.

Material: Acrylic
 Thickness of sides: 4 mm approx.
 Dimensions: 430x150x150 mm³

P-1017785



CT Scanner

CT scanner for turning and moving samples for the purpose of generating tomographic images. All turning and movement is carried out by means of stepper motors. While the measurement is taking place, the scanner moves the sample backwards and forwards between the ultrasonic sensors connected to the outside of the sample container in accordance with the CT algorithm. Includes a sample stage for making recordings of suitable objects for observation. The sample stage is immersed in a sample trough. The whole slider is height adjustable so that it is possible for the area of the sample under investigation to be modified.

Linear movement: max. 400 mm
 Local resolution: <10 μm
 Maximum speed of movement: 18 cm/min
 Turning angle: 0 – 360°
 Angular resolution: 0.225°
 Maximum angular velocity: 1 rpm
 Dimensions: 210x353x520 mm³

P-1017782

CT-Sample

Black plastic cylinder with non-uniform absorption and speed of sound within its interior. With magnetic holder for attachment to the revolving stage of the CT scanner. In the case of ultrasonic tomography, two different measurement variables can be recorded, absorption and speed of sound.

Diameter: 60 mm
 Height: 70 mm

P-1017784



ENERGY AND THE ENVIRONMENT

Halogen Lamp 500 W (230 V, 50/60 Hz)

Strong light source for experiments, e.g. for use with the kit "Principles of the Solar Thermal Collector" (P-1000839). With handle.

P-1000894

Additionally required:

P-1002835 Stand Base

Spare Bulbs for Halogen Lamp – 500 W (230 V, 50/60 Hz)

P-1003536



Principles of the Solar Thermal Collector

Set of equipment including four test bodies with different surface coating, heat insulators and covers for experiments on the utilisation of solar energy. Four series of measurements that can be completed in approximately 25 minutes elucidate the temperature characteristics and peaks of the test bodies when exposed to sunlight. The kit comes in a robust storage case.

Storage capacity: approx. 365x310x70 mm³

Weight: approx. 1 kg

Contents:

- 4 Solar measuring bodies, each of a different colour
- 2 Insulating housings
- 2 Mounts for the measuring bodies
- 1 Transparent acrylic plate
- 4 Thermometers, -10 – +110° C

P-1000839

Additionally required:

P-1000894 Halogen Lamp, 500 W (230 V, 50/60 Hz)

Tomorrow's Energy Carriers

Fuel cells, electrolysers, solar hydrogen technology – significant contributors to a sustainable energy supply in the future: preservation of the environment and resources while maintaining today's standard of living. Now you can demonstrate the mode of operation of this fascinating technology to your students. Pure water is broken down by means of electrolysis into hydrogen and oxygen for the purpose of energy storage with the help of regenerative energy. During reconversion of the gases in a fuel cell, electricity, heat and water are formed. The resolute use of membrane technology in the training and demonstration systems does away with the use of corrosive liquids and only distilled water is required.

Fuel Cell Demonstration System

Model showing the function of a hydrogen solar cell consisting of: • Solar module; • PEM electrolyser; • Hydrogen and oxygen accumulators; • PEM fuel cell; • Fan

Conveniently arranged on a baseplate.

Solar module: 2.0 V / 350 mA

Electrolyser: 1 W

Fan output: 10 mW

Dimensions: approx. 100x300x150 mm³

Weight: approx. 600 g

P-1002689

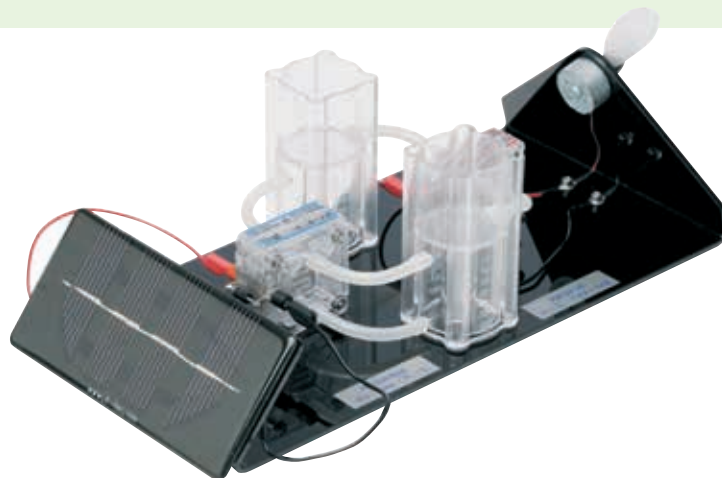

For your safety:

Exclusive use of distilled water.

No corrosive electrolytes such as potassium hydroxide (KOH).

Greenhouse Effect Kit

A set of equipment permitting quick and easy experiments to demonstrate the effect of greenhouse gases on the absorption of infra-red radiation. Solar radiation received by the earth is simulated here by means of short-wave infra-red radiation that is attenuated by absorption in water and visible light from a reflector lamp. Infra-red radiation emitted by the earth is simulated by heating a black metal disc. Both types of radiation are made to pass through air or butane gas in a metal tube and subsequently registered with a thermopile. Comparison of the obtained values reveals that long-wave infra-red radiation is absorbed to a high degree by butane gas. Consequently butane gas released into the atmosphere causes it to heat up, i.e. butane gas is a greenhouse gas.

Contents:

- 1 Base plate
- 1 Lamp holder with reflector lamp
- 1 Cuvette on stem
- 1 Black metal disc
- 1 Metal tube, simple
- 1 Metal tube, with taps
- 2 Mounting stems
- 1 Silicone hose
- 1 Storage case

Greenhouse Effect Kit (230 V, 50/60 Hz)
P-1000837

Greenhouse Effect Kit (115 V, 50/60 Hz)
P-1009764

Additionally required:

P-1000824 Moll-Type Thermopile

Butane (lighter gas)

P-1001028 Measuring Amplifier S

P-1000866 Transformer 12 V (230 V, 50/60 Hz)

or

P-1000865 Transformer 12 V (115 V, 50/60 Hz)

P-1013527 Analogue Multimeter ESCOLA 100

Alternative:

P-1020742 Measuring Amplifier U (230 V, 50/60 Hz)

or

P-1020744 Measuring Amplifier U (115 V, 50/60 Hz)

P-1002781 Digital Multimeter P1035

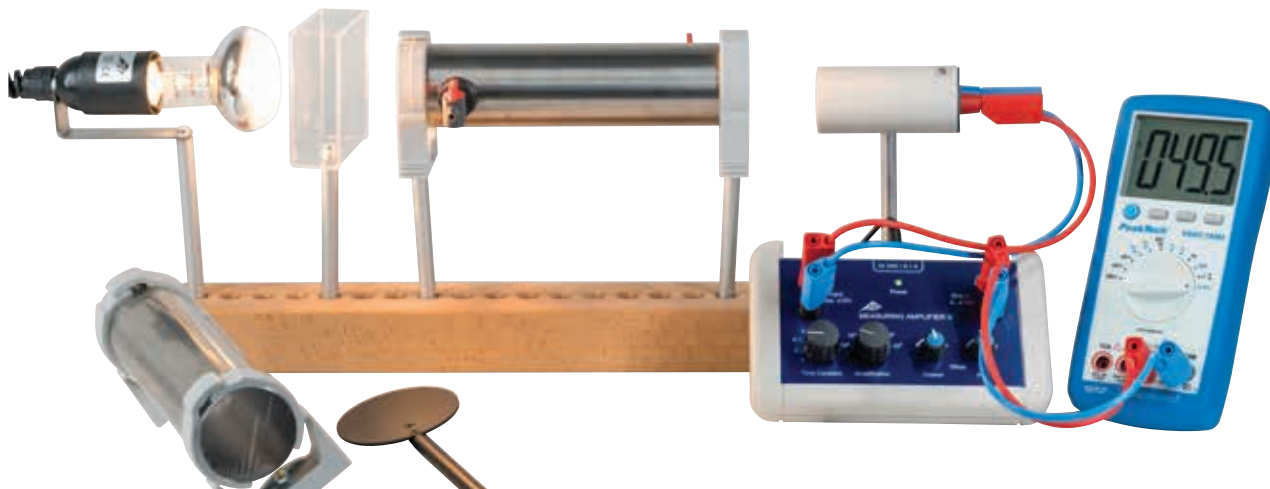



Infra-red Temperature and Humidity Gauge

Digital measuring device for contact-free temperature measurement from large distances, e.g. of hot or moving objects or inaccessible points of measurement, and for simultaneous humidity display. With laser diode as detection aid, integrated in the measuring probe, illuminated LCD display, max and data-hold function, switchable between °C and °F, automatic switch-off. Includes pouch and battery.

Measuring range, temperature: -50° C – +500° C; -58° F – +932° F
 Divisions: 0.1° C/F
 Accuracy: ±2% of measured value ±2° C / 4° F
 Measuring range, humidity: 5% – 95%
 Divisions: 0.1%
 Accuracy: ±3.5%
 LCD dual-function display: 3½-digit, 21 mm with backlighting
 Voltage supply: 9 V battery
 Dimensions: approx. 90x170x45 mm³
 Mass: approx. 360 g

P-1002795



Precision Hair Hygrometer

Hygrometer for measuring the relative air humidity, consisting of a round plastic housing with a synthetic hair as the measuring element. The specially treated hair exhibits an almost inertia free response to changes in humidity. Wall mountable.

Measuring range: 0% – 100% relative humidity
 Temperature range: -35° C – +65° C
 Reading accuracy: ± 5%
 Diameter: 100 mm

P-1002877



Digital Pocket Anemometer

Waterproof anemometer for measuring wind speed. Indication of wind chill temperature based on the combination of air temperature and wind speed. Indication of mean and maximum speeds. Wind curves on the Beaufort scale. Supplied with closeable cover.

Wind speed: 0.2 – 30 m/s
 Accuracy: ±5% of mean wind speed
 Units: km/h, m/h, m/s or knots
 Temperature: -30° – +59° C
 Battery: 3.0 V (CR2032)
 Dimensions: approx. 137x50x18 mm³

P-1010250



Digital Hygro-Thermometer

Digital measuring device for displaying exterior and interior temperature and humidity. With min/max function and acoustic signal if exterior temperature drops to or below zero, switchable between °C and °F, on/off button, eyelet for hanging up and fold-out stand.

Measuring range:

Temperature (interior): 0° C – +50° C / 32° F – +122° F
 Temperature (exterior): -50° C – +70° C / -58° F – +158° F
 Humidity: 20% – 99%
 Divisions: 0.1° C/F, 1%
 Accuracy (temp.): ±1° C / ±2° F
 Accuracy (humidity): ±3%
 Exterior temperature sensor: Cable length 3 m

P-1003011

Wireless Weather Station

Weather station with wireless detection of external temperatures from up to three sensors situated at distances of up to 25 m. Display of internal temperature and humidity. Features switchable °C/°F display, min/max function, weather forecasting, trend displays for air pressure and radio-controlled clock with date function. Supplied with one external temperature sensor, two 1.5-V AA batteries and two 1.5-V AAA batteries. Silver/grey housing. Can be suspended or set up on a surface.

External temperatures: -30° C – +70° C

Internal temperatures: 0° C – +60° C

Humidity: 1 – 99%

P-1010248



Noise Level Indicator SPL

Handy and easy-to-use noise level meter with digital display in decibels (dB) and an arbitrarily adjustable trigger threshold for use as a traffic-light style noise indicator with a happy green face and a sad red face.

Can be mounted on a wall or set up on a table top. Its well-conceived compact design makes it easy to transport. Automatically switches to electricity-saving stand-by mode when noise is low for a long period. The brightness of the display can also be adjusted. Includes a stand base, USB/miniUSB cable and USB power supply.

Display:	100 mm diam, with LED
Measuring range:	40 dB – 130 dB
Resolution:	1dB
Thresholds for colour display:	Adjustable to any level in steps of 1 dB
Power supply:	5 V DC via miniUSB socket
Power consumption:	150 mA (normal operating mode) <1 mA (stand-by)
USB power supply:	100 – 240 V, 50/60 Hz
Dimensions:	approx. 130x145x12 mm ³
Weight:	approx. 400 g

P-1012741



Noise: the World's no. 1 Pollutant

Noise

- damages hearing
- makes it more difficult to hear genuinely important signals
- impedes both physical and mental work
- disturbs and adversely affects well being
- disturbs relaxation and sleep
- can cause chronic stress, physical ailments and illness



HEAT AND THERMODYNAMICS



K-Type NiCr-Ni Immersion Sensor, -65° C to 550° C

Temperature measurement sensor with stainless steel (V4A)-tube, spring-mounted (rigid) and silicone cable.

Measuring range: -65° C – 550° C
 Response time: approx. 3 s
 Tube: 130 mm x 1.5 mm diam.

P-1002804

K-Type NiCr-Ni Immersion Sensor, -200° C to 1150° C

Sheath thermocouple with stainless steel (Inconel) tube, flexible and silicone cable.

Measuring range: -200° C – 1150° C
 Response time: approx. 3 s
 Tube: 150 mm x 1.5 mm diam.

P-1002805

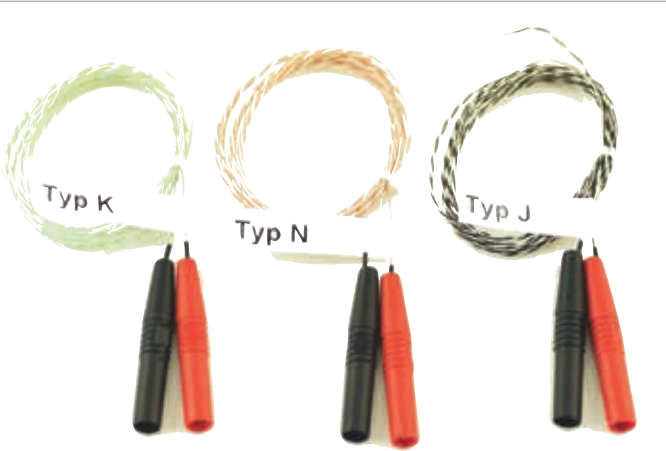
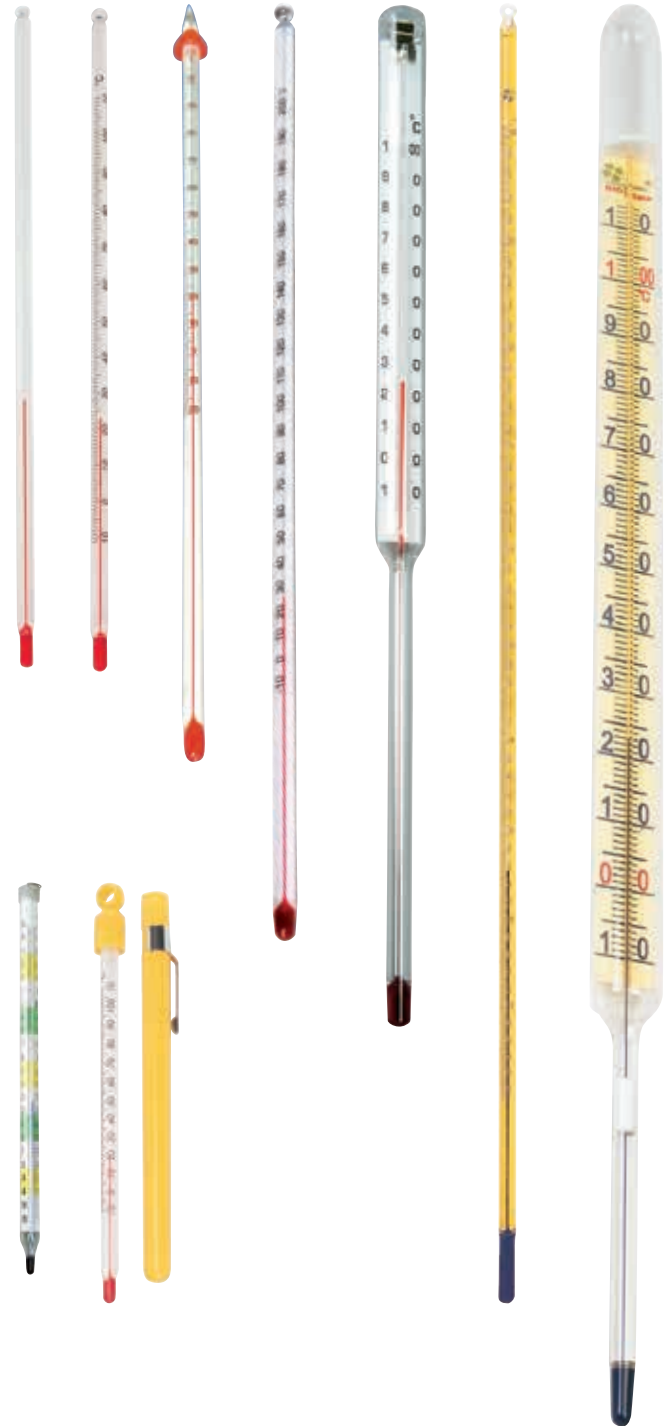

Set of 3 Thermocouples

Set consisting of three different thermocouples for demonstrating the Seebeck effect and measuring thermo-electric voltage as a function of the difference in temperature from a specific reference point. In each case, to create a temperature difference, the contact point of the thermocouple is immersed in a water bath.

Length of leads: 2 m
 Operating temperature: -75°C to 250°C
 Connection: 4-mm safety plugs
 Sensitivity: 30 $\mu\text{V/K}$ (NiCrSi-NiSi)
 43 $\mu\text{V/K}$ (NiCr-NiAl)
 54 $\mu\text{V/K}$ (Fe-CuNi)

Contents:

- 1 Thermocouple type N, NiCrSi-NiSi
- 1 Thermocouple type K, NiCr-NiAl
- 1 Thermocouple type J, Fe-CuNi

P-1017904



Thermometer Clip

Stainless steel clip for holding thermometers in beakers.

P-1003528

Art. No.	Scale division	Measuring range	Scale division	Dimensions	Remarks
P-1002881	Pocket Thermometer	-10° – 110° C	1° C	165 mm x 10 mm diam.	Tube type, scale on white background, special red filling, in yellow plastic protective case with clip.
P-1002879	Tube Thermometer, graduated	-10° – 110° C	1° C	260 mm x 6 mm diam.	Glass thermometer with eyelet, scale on white background, special red filling, in transparent square plastic case.
P-1002880	Tube Thermometer, not graduated	–	–	290 mm x 6 mm diam.	For demonstrating function and mode of operation of thermometers. Like P-1002879 but without scale.
P-1003384	Thermometer	-20° – 110° C	1° C	295 mm x 6.3 mm diam.	Tube type with anti-roll design, white coated capillary, red alcohol filling, packed in a plastic tube.
P-1003385	Thermometer	-10° – 150° C	1° C	295 mm x 6.3 mm diam.	Tube type with anti-roll design, white coated capillary, red alcohol filling, packed in a plastic tube.
P-1003386	Thermometer	-20° – 110° C / 0° – 230° F	1° C/F	295 mm x 6.3 mm diam.	Tube type with anti-roll design, white coated capillary, red alcohol filling, packed in a plastic tube.
P-1003387	Thermometer	-20° – 150° C / 0° – 300° F	1° C/F	295 mm x 6.3 mm diam.	Tube type with anti-roll design, white coated capillary, red alcohol filling, packed in a plastic tube.
P-1003525	Thermometer	-10° – 200° C	1° C	300 mm x 6 mm diam.	Rod-shaped general-purpose thermometer, white-coated capillary, red indicator liquid, total immersion depth.
P-1003526	Rod Thermometer	-10° – 100° C	1° C	350 mm x 8 mm diam., Length of rod: 150 mm	Rod thermometer with internal scale made of frosted glass, prismatic capillary tube and red liquid.
P-1003013	Stable Tube Type Thermometer	-1° – 101° C	0.2° C	460 mm x 7 mm diam.	Stable tube type thermometer with biodegradable special blue filling, scale on yellow background, with eyelet.
P-1003014	Demonstration Thermometer	-10° – 110° C	1° C	650 mm x 30 mm diam.	Extra-large tube type thermometer with biodegradable special blue filling, easy-to-read scale on yellow background.

Digital Quick-Response Pocket Thermometer

For instantaneous measurements on surfaces, in liquids, soft plastic media, air/gases, very small objects. For connection to a K-type NiCr-Ni measurement sensor. Sensor not included in scope of supply.

Measuring range: -65° C – 1150° C / -85° F – 1999° F in 2 ranges

Division: 0.1° C / 1° C/F

Accuracy in

lowest range: 0.05% of measured value ±0,2% FS

Display: 3½-digit LCD display, 13 mm in height

Dimensions: approx. 106x67x30 mm³

Mass: approx. 135 g

P-1002803

Additionally required:

P-1002804 K-Type NiCr-Ni Immersion Sensor, -65° C to 550° C

or

P-1002805 K-Type NiCr-Ni Immersion Sensor, -200° C to 1150° C





Digital Thermometer Type K/IR

Digital two channel thermometer with two K-type inputs and additional external infra-red sensor. Can also be used for measurements at low temperatures. With automatic shut off, maximum value storage and data hold function. Includes case, 2 K-type thermocouple sensors, infra-red temperature sensor, 9 V battery and instruction manual.

- Measurement inputs: 2x K-type, external IR input
- Measuring functions: T1, T2, T3, T1-T2, T1-T3, T2-T3
- Measuring range: -200 – 1372°C (type K), -30 – 550°C (IR)
- Measurement error: ±0.5% • 2°C (type K), ±2.5% +2°C (IR)
- Resolution: 0.1°C
- Unit of measurement: °C or K
- Emission factor: 0.95 fixed
- Digital display: 3½ digit LCD
- Background lighting: blue
- Operating voltage: 9 V battery
- Dimensions: approx. 75x200x50 mm³
- Mass: approx. 280 g

P-1002799



Digital Thermometer, Min/Max

Insertion thermometer with Hold and Min/Max function in robust plastic housing and temperature sensor made of stainless steel. Switchable between °C and °F, On/Off switch, hanging strap and folding angled support.

- Measuring range: -50° C – 200° C / -58° F – 392° F
- Division: 0.1° C/F
- Dimensions: approx. 95x65x20 mm³
- Cable length: approx. 1400 mm
- Measurement probe: approx. 120 mm

P-1003010



Insertion Thermometer F

Waterproof digital thermometer with a 125 mm long sensor to measure the temperature of liquid, pulverulent and soft substances. With memory function, min/max function, reversible °C/°F. Plastic casing, clip and LR 44 button battery included.

- Measuring range: -40 – +200°C
- Accuracy: ±0.8°C (from 0 – 100°C), ±1°C (from -20 – 0°C), ±1.5°C (others)
- Measurement interval: 1 s
- Dimensions: approx. 205x20x17 mm³
- Mass: approx. 56 g

P-1010219



Insertion Thermometer

For measuring the temperature in air, liquids and soft materials. Temperature sensor made of stainless steel with protective case, switchable between °C and °F, On/Off switch and automatic switch-off.

- Measuring range: -50° C – 150° C / - 58° F – 302° F
- Division: 0.1° C/F
- Accuracy: ±1° C / ±2° F
- Temperature sensor: approx. 130 mm x 4 mm diam.
- Mass: approx. 29 g

P-1003334



Digital Pocket Thermometer

Temperature sensor made of stainless steel with protective case, watertight, switchable between °C and °F, Min/Max/Hold function, automatic switch-off.

- Measuring range: -40° C – 200° C / -40° F – 392° F
- Division: 0.1° C/F
- Accuracy: ±1° C / ±2° F
- Dimensions: approx. 150x20x18 mm³
- Mass: approx. 20 g

P-1003335

Infra-red Thermometer

Surface thermometer for contactless temperature measurement from a safe distance, e.g. in inaccessible places, hot or moving objects. With laser diode for laser sighting, illuminated LCD display, range overflow display, measured value storage function, selection between Celsius and Fahrenheit, automatic switch off. The infra-red thermometer P-1020909 permits rapid measurement of temperature differential with the LED display (red, green or blue). Including case, battery and instruction manual.



Advantages

- Fast, easy and accurate measurements
- Automatic selection of measurement range
- Practical single-handed operation
- Modern, handy design
- Large-scale 3½-digit LCD display

	P-1002791	P-1020909
Designation	A. Infra-red Thermometer, 800° C	B. Infra-red Thermometer, 380° C D
Measuring range	-50° C – +800° C -58° F – +1472° F	-50° C – +380° C -58° F – +716° F
Division	0,1° C/F	0,1° C/F
Accuracy	±1% of measured value ±1° C / 1.8° F	2% of measured value ±2° C / 4° F
Response time	150 ms	< 1 s
Optical resolution	20:1	10:1
Max. temperature display	yes	–
Alarm function	high/low	high/low
Voltage supply	9 V battery	9 V battery
Dimensions	approx. 146x43x104 mm ³	approx. 160x82x45 mm ³
Mass	approx. 170 g	approx. 180 g

NEW

Thermal Imaging Camera

Modern infra-red thermal imaging camera for producing images of infra-red radiation from an object based on detected infra-red radiation in relation to the ambient temperature.

- User-friendly graphic menu operation
- Photography using built-in digital camera
- Up to 25000 photos can be saved on Micro SD card
- Recordings featuring time and date documentation
- Images with emission factor and measurements
- Five colour palettes for thermal imaging
- Five levels of photograph and thermal imaging superimposition
- Cross-hairs, plus cold-spot and hot-spot display
- Minimum and maximum value display
- Automatic shut-off

Includes case, batteries, Micro SD card and instruction manual.

Temperature range: -20°C – 300°C
-4°F – 572°F

Resolution: 0.1°

Sensitivity: 0.3°C

Precision: ±2% or 2°C (4°F)

Display: 60 mm (2.4") LCD-TFT

Thermal image resolution: 60 x 60 pixels

Field of vision: 20° x 20°

Emission factor: Adjustable from 0.1 – 1.0

Wavelength: 8 – 14 μm

Image frequency: 6 Hz

Focus range: 50 cm (fixed)

Memory: Micro SD card

Voltage supply: 4 x 1.5 V AA batteries

Display: Multi-line, multi-function display

Dimensions: approx. 212 x 95 x 62 mm³

Weight: approx. 320 g

P-1020908 £469.00



	P-1002793	P-1002794
Designation	Digital Thermometer, 1 Channel	Digital Thermometer, 2 Channels
Measuring range	-50° C – +1300° C -58° F – +2000° F 223 K – 2000 K	-50° C – +1300° C -58° F – +2000° F
Division	0.1° C/F, 1 K	0.1° C/F
Accuracy	±0.5% +1° C / +2° F ±1% +2 K	±0.5% +1° C / +2° F
Display	3½-digit illuminated LCD	3½-digit illuminated LCD
Digit size	21 mm	21 mm
Voltage supply	9 V battery	9 V battery
Dimensions	approx. 90x170x45 mm ³	approx. 90x170x45 mm ³
Mass	approx. 350 g	approx. 350 g

Digital Thermometer

Versatile digital thermometer for type-K temperature sensors with single or dual input (P-1002794) for measuring instantaneous or differential temperature T1 – T2 (P-1002794). With storage of maxima and Data-Hold function. Includes type-K temperature sensor (P-1002794 2x), battery, holster and carrying bag.



Heat Equivalent Apparatus

Apparatus for determining the specific heat capacity of aluminium and for confirming the energy conservation law. The robust heat equivalent apparatus consists of a shaft with ball bearings at both ends, an integrated counter for measuring the number of revolutions performed and an attached table clamp for securing the device. The aluminium calorimeter body heats up as a result of frictional work or electrical energy from the integrated heating element. An NTC thermistor, acting as a temperature sensor and located in an aluminium case, determines the temperature. The calculation can be performed easily using the temperature calibration table printed on the apparatus.

Length: 230 mm
 Span of the table clamp: 10 – 65 mm span
 Cord length: approx. 1.80 m
 Calorimeter body: 50 mm x 48 mm diam.
 Electric heater power: 10 V, 1 A
 Weight calorimeter: 250 g
 Total mass : approx. 1200 g

Contents:

- 1 Basic unit
- 1 Aluminum calorimeter
- 1 Temperature sensor
- 1 Pair of adaptor cables with 4 mm safety plugs/2 mm plugs
- 1 Friction belt
- 1 Bucket, 5 l
- 1 Counterweight

P-1002658

Additionally required for temperature measurement:

P-1002781 Digital Multimeter

Additionally recommended:

P-1003312 DC Power Supply, 0 – 20 V, 0 – 5 A (230 V, 50/60 Hz)

or

P-1003311 DC Power Supply, 0 – 20 V, 0 – 5 A (115 V, 50/60 Hz)

P-1002659 Copper Calorimeter



2030300
PDF online

Calorimeter Bodies

Calorimeter bodies for the heat equivalent device and for determining the specific heat capacity. With borehole for holding temperature sensor and with integrated heating element.

Electric heater power: 10 V, 1 A

Heating element

connection: via 2-mm sockets

Dimensions: approx. 50 mm x 48 mm diam.

Weight: approx. 750 g (Cu) / 250 g (Al)

Copper Calorimeter

P-1002659

Aluminium Calorimeter

P-1017897

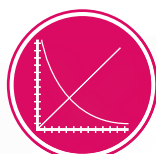

E2030400

PDF online



P-1017897



P-1017898



P-1002659



Temperature Sensor

Temperature sensor (NTC thermistor) for use with calorimeter bodies (P-1002659 and P-1017897).

P-1017898

Pair of Adapter Cables with 4 mm Safety Plugs/2 mm Plugs

Cables for connection to contacts of heating elements in calorimeter bodies (P-1002659 and P-1017897).

P-1017899



Calorimeter, 200 ml

For determining temperatures of mixtures, specific heat capacities, conversion energies of substances and heat of fusion of ice. Designed for simple experiments for students. Plastic container with styrofoam inlay.

Capacity of insulated container: approx. 200 ml

Weight: approx. 80 g

P-1000823

Additionally required:

P-1003526 Tube Thermometer, -10 – +100° C

Additionally recommended:

P-1000832 Aluminium Shot, 100 g

P-1000833 Copper Shot, 200 g

P-1000834 Glass Shot, 100 g



P-1021155



P-1000822

Set of 4 Calorimeter Cylinders

Four cylindrical metal calorimeter blocks, each of mass 1 kg, for determining the specific thermal capacities of aluminium, brass, copper and steel. Each calorimeter cylinder has two holes for inserting a heating element (P-1003258) and a thermometer or temperature sensor.

Hole for heating element: 12.5 mm diam.

Hole for thermometer: 8 mm diam.

P-1003253

Additionally required:

P-1003258 Immersion Heater, 12 V

Thermometer or Temperature Sensor

Art. No.	Material	Height	Dia- meter	Specific heat J/(kg·K)
P-1003254	Aluminium	84 mm	75 mm	896
P-1003255	Brass	84 mm	44 mm	377
P-1003256	Copper	85 mm	43 mm	385
P-1003257	Steel	92 mm	44 mm	452

Calorimeter with Heating Coil, Pluggable, 1200 ml

Calorimeter for determining specific heat capacities, conversion energies of materials, mixing temperatures as well as measurement of electrical equivalents of heat. Consists of a double-walled, heat-insulating plastic container with an insulating vessel inside made of reflecting glass, with heating coil and stirrer. Also includes a lid with an opening for a thermometer and two 4 mm plugs for connecting the power supply for the heating coil. If necessary, the heating coil can be removed from the inside of the lid. Two plastic nets for safe loading of samples are included.

Max. heater voltage: 25 V

Max. heating power: approx. 160 W

Contents of insulated container: approx. 1200 ml

Dimensions: approx. 240 mm x 120 mm diam.

Weight: approx. 0.8 kg

P-1021155

Additionally required:

P-1002793 Digital Thermometer, 1 Channel

Alternative:

P-1021477 VinciLab

P-1021498 Thermocouple Type K

Additionally recommended:

P-1003253 Set of 4 Calorimeter Cylinders

P-1003312 DC Power Supply, 0 – 20 V, 0 – 5 A (230 V, 50/60 Hz)

or

P-1003311 DC Power Supply, 0 – 20 V, 0 – 5 A (115 V, 50/60 Hz)



Immersion Heater, 12 V

Sheathed heater suitable for the metal block calorimeters (from P-1003253).

Operating voltage: max. 12 V

Power: max. 50 W (nominal)

Tubing: 150 mm long

Heated section: 70 mm

Electrical connection: 4 mm sockets

P-1003258

Additionally required:

P-1003558 Transformer with Rectifier

2/ 4/ 6/ 8/ 10/ 12/ 14 V, 5 A (230 V, 50/60 Hz)

or

P-1003557 Transformer with Rectifier

2/ 4/ 6/ 8/ 10/ 12/ 14 V, 5 A (115 V, 50/60 Hz)

Calorimeter with Heating Coil, 150 ml

For determining the specific heat capacity of solids and liquids and for measuring the electric heat equivalent. Two mutually insulated aluminum beakers, lid with rubber stopper with boreholes for thermometer and stirrer, with heating coil.

Capacity of insulated container: 150 ml

Connection sockets: 4 mm

Electric heater: 6 V/2 A max.

P-1000822

Additionally required:

P-1002879 Tube Thermometer, -10 – +110°C

Additionally recommended:

P-1000832 Aluminium Shot, 100 g

P-1000833 Copper Shot, 200 g

P-1000834 Glass Shot, 100 g

P-1003312 DC Power Supply, 0 – 20 V, 0 – 5 A (230 V, 50/60 Hz)

or

P-1003311 DC Power Supply, 0 – 20 V, 0 – 5 A (115 V, 50/60 Hz)

> Demonstrate the forces resulting from changes in length arising from heat or cold. These forces are sufficient to break a 10-mm iron bolt.



Tyndall's Bar Breaker

U-shaped clamping set up with a metal rib and fastening screw for demonstrating the linear expansion of metals on heating, as well as the tremendous forces which can be exerted in the process. The set includes 10 cast-iron bolts for breaking in the course of the experiment.

Diameter for bolt hole: approx. 11 mm
 Length of clamping fixture: approx. 285 mm
 Weight: approx. 1400 g

P-1000829



Ball and Ring

Brass ball and brass ring with plastic handles for demonstrating the thermal expansion of solid bodies. After heating in a burner flame, the ball no longer fits through the cold ring.

Length: approx. 250 mm

P-1003382

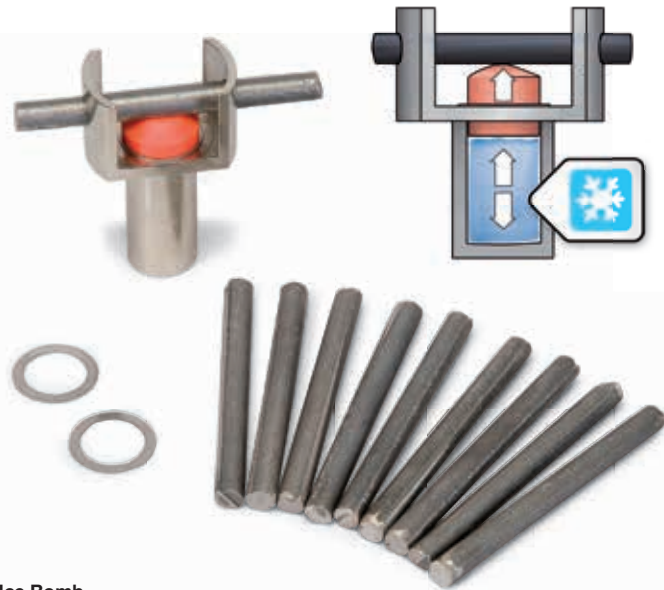

Ice Bomb

Clamping set up for demonstrating volumetric expansion of water on freezing, as well as the tremendous forces which can be exerted in the process.

Comprises a steel cylinder with a clamping rib and plastic lid. The set includes 10 cast-iron bolts for breaking in the course of the experiment.

Diameter for bolt hole: approx. 11 mm
 Dimensions: approx. 40x30x75 mm³
 Weight: approx. 620 g

P-1000828

Cast Iron Bolts, Set of 10 Bolts

Spare bolts to be used with Tyndall's bar breaker (P-1000829) or the ice bomb (P-1000828).

P-1000827



Ball with Ring

An arrangement for demonstrating the expansion of solids on heating. After heating in a burner flame, the ball no longer fits through the bore in the bracket. Steel ball with chain and handle.

Dimensions of the bracket in mm: approx. 40x50x40 mm²
 Diameter of ball: approx. 22 mm
 Length of handle with shaft: approx. 225 mm
 Weight: approx. 175 g

P-1000831

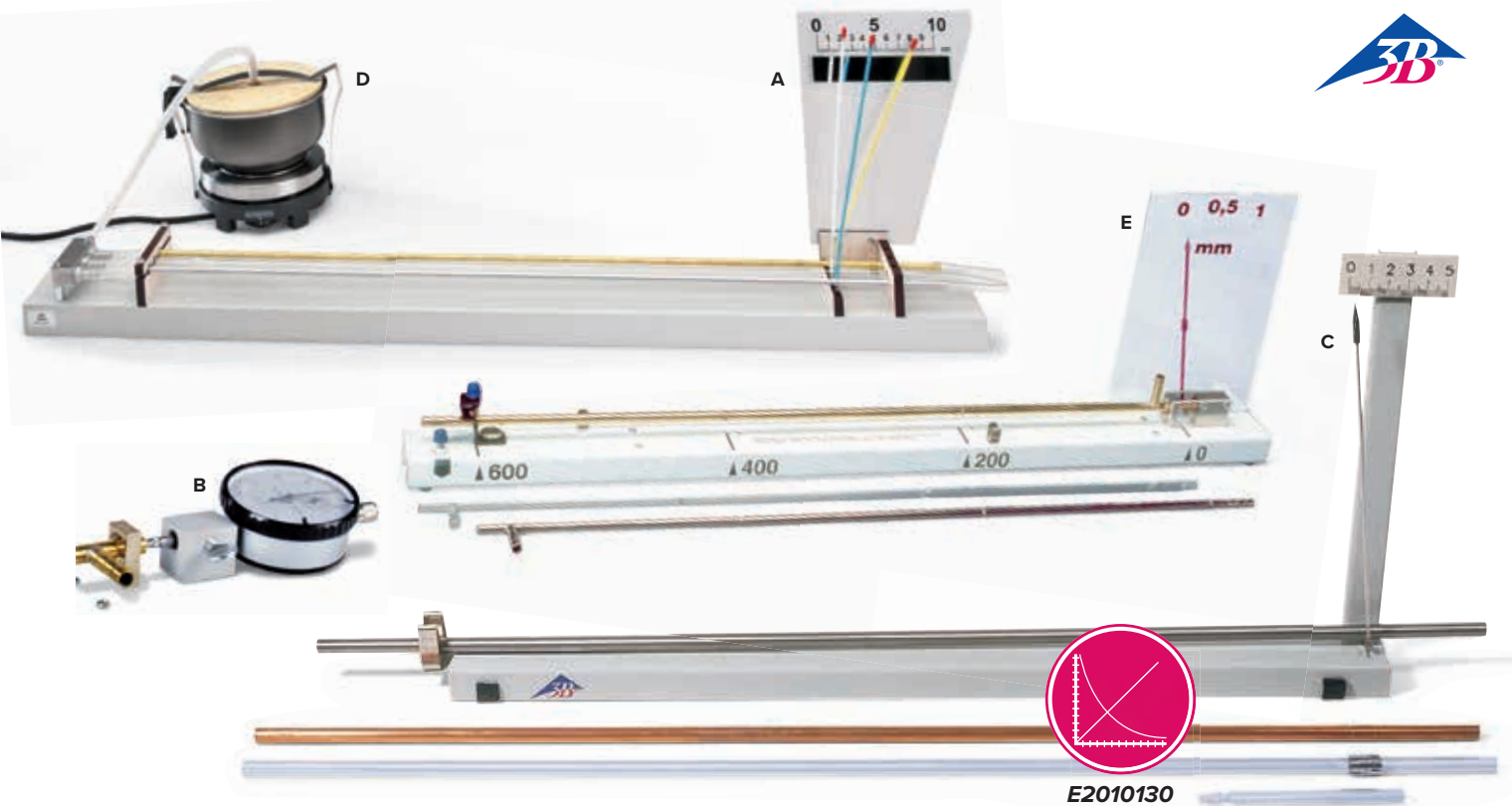

E2010130
PDF online

A. Linear Expansion Apparatus with Three Pointers

Apparatus for measuring the linear expansion of different kinds of solids simultaneously. The set includes three sample tubes (brass, aluminium and glass) which are heated by passing steam through them. Linear expansion is indicated on a mirror scale by three differently coloured pointers mounted on rollers. Includes silicone tubing.

Dimensions of the tubes: 700 mm x 6 mm diam.
Dimensions: approx. 830x80x70 mm³
Weight: approx. 1.2 kg

P-1000830

Additionally required:

D. P-1001049 Steam Generator (230 V, 50/60 Hz)

or

D. P-1006769 Steam Generator (115 V, 50/60 Hz)

B. Gauge with Adapter

Analogue gauge for measuring minimal changes in length plus an adaptor for fitting a gauge dial as an enhancement to the extension apparatus D (P-1002977).

P-1012862

C. Linear Expansion Apparatus S

A device for measuring the linear expansion of solids as a function of length and material. Includes three sample tubes (iron, copper and glass) which are heated by passing water vapour through them. Consists of a base strip with a clamping spring, pointer, scale and hose nipple.

Pointer ratio: 1:50
Tube length: approx. 630 mm
Dimensions: approx. 530x60x240 mm³
Weight: 0.6 kg

P-1002978

Additionally required:

D. P-1001049 Steam Generator (230 V, 50/60 Hz)

or

D. P-1006769 Steam Generator (115 V, 50/60 Hz)

P-1002622 Silicone Tubing, 1 m

D. Steam Generator

Device for generation of steam, e.g. in experiments on thermal expansion. Aluminum vessel with cork lid and retainer on an adjustable hot plate with a thermal circuit breaker.

Hotplate: 90 mm diam.
Power consumption: 500 W
Vessel volume: 250 ml
Dimensions: 170 mm x 180 mm diam.
Hose connection: 6 mm diam.
Total mass: approx. 1 kg

Steam Generator (230 V, 50/60 Hz)

P-1001049

Steam Generator (115 V, 50/60 Hz)

P-1006769

E. Linear Expansion Apparatus D

A device for measuring the linear expansion of solids as a function of length and material. Includes three sample tubes (steel, brass and glass) which are heated by passing water vapour through them. Consists of a base strip with a fixed bearing, pilot bearing, pointer and projectable scale.

Scale dimensions: 140x200 mm²
Measuring range: 1 mm
Reading accuracy: 0.05 mm
Tube length: approx. 650 mm
Dimensions: approx. 730x50x200 mm³
Weight: approx. 2 kg

P-1002977

Additionally required:

D. P-1001049 Steam Generator (230 V, 50/60 Hz)

or

D. P-1006769 Steam Generator (115 V, 50/60 Hz)

P-1002622 Silicone Tubing, 1 m

Additionally recommended:

B. P-1012862 Gauge with Adapter

Experiment Topics:

- Thermal anomaly
- Density maximum

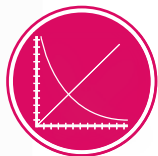

UE2010301
PDF online



A. Device for Demonstrating the Anomaly of Water

Apparatus for demonstrating the thermal anomaly of water, measuring its thermal expansion and determining its maximum density. Consists of a Duran glass vessel with an inlet tube and two GL screw connections for mounting the riser tube with a mm scale and a or thermometer. Includes stirring rod.

- Volume: 250 ml
- Riser tube: 400 mm
- Capillary: 1.5 mm diam.
- Hose nipple: 8 mm
- Overall height: approx. 500 mm

P-1002889

Additionally required:

- B. P-4000036 Plastic Trough**
- C. P-1002808 Magnetic Stirrer**
- P-1003013 Tube Thermometer**
- or
- D. P-1002793 Digital Thermometer**
- and
- E. P-1002804 K-Type NiCr-Ni Immersion Sensor, -65°C – 550°C**

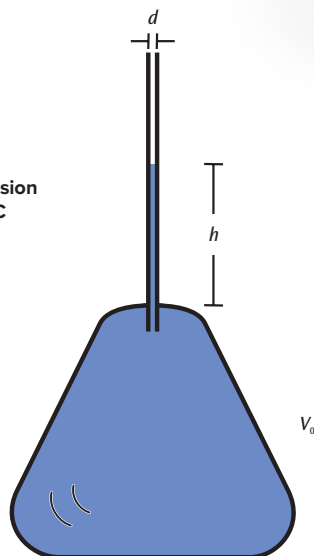

Vessel with riser tube

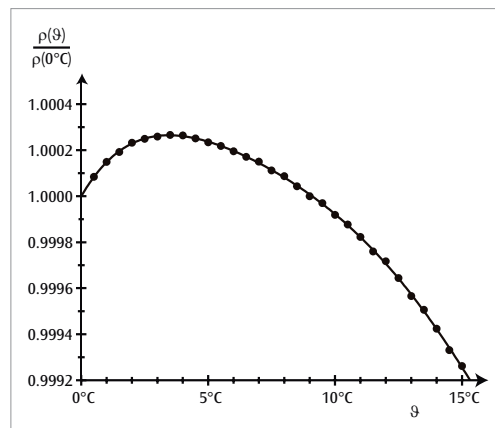

Determining the maximum density of water



Gas Expansion Apparatus

Glass vessel with ground-glass sealing joints for demonstrating the expansion of air when heated. The U-tube is filled with water at room temperature and the water levels are marked. Even the heat from a hand is enough to cause the air in the flask to expand so that the water levels in the U-tube change visibly.

- Height: approx. 230 mm
- P-1003511**

Volume Dilatometer

Glass vessel for investigating changes in volume in a liquid as a function of temperature and for determining volumetric expansion coefficients. With ground graduated riser tube.

- Volume: 50 ml
- Length of riser tube: 120 mm
- Scale: mm scale
- P-1018001**



Heat-Flow Device S

Stable glass flask on a stand for demonstrating the flow of heat in a non-uniformly heated liquid. With filling hole for filling with water and a small quantity of potassium permanganate crystals for colouring.

Glass flask: approx. 300x150 mm²
 Tube diameter: approx. 14 mm
 Height: approx. 250 mm

P-1003512

Additionally required:

P-1003565 Spirit Lamp

Potassium permanganate for use as a colouring agent



Heat-Flow Device

Stable glass flask with rectangular bends for demonstrating the flow of heat in a liquid that is heated non-uniformly. With GL18 screw fitting and side-limbs for filling with water, and a small quantity of potassium permanganate for colouring.

Dimensions: approx. 420x420 mm²
 Tube diameter: approx. 30 mm

P-1002903

Additionally required:

P-1002836 Tripod Stand, 185 mm

P-1002934 Stainless Steel Rod, 470 mm

P-1002830 Universal Clamp

P-1002833 Universal Jaw Clamp

P-1003565 Spirit Lamp

Potassium permanganate for use as a colouring agent



Heat Conductivity Device

A device with five metal bars for comparing the thermal conductivity of aluminium, brass, steel, zinc and copper – by melting wax balls at the rod ends. The five rods extend in a star-shaped configuration from a brass hub. Each rod has a notch for holding wax.

Length: approx. 340 mm

P-1003383

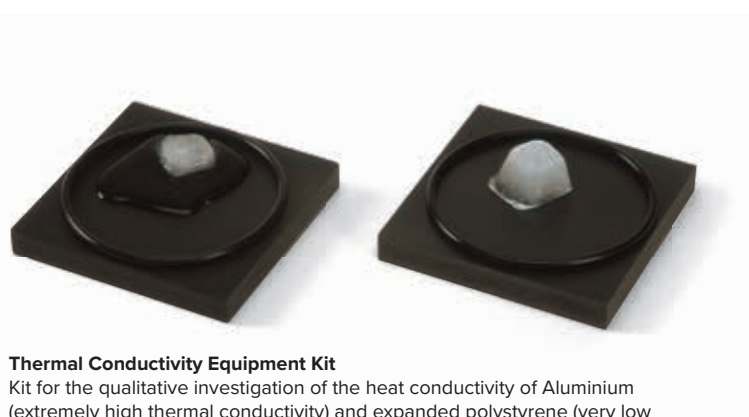

Thermal Conductivity Equipment Kit

Kit for the qualitative investigation of the heat conductivity of Aluminium (extremely high thermal conductivity) and expanded polystyrene (very low thermal conductivity). Even at room temperature the varying material temperatures are evident to the touch. In the experiment ice cubes are placed on the plates. The ice cube on the seemingly colder Aluminium plate melts much more quickly (in 1 – 2 minutes), while there seems to be no melting at all of the ice cube on the seemingly warmer plastic plate. Two rubber rings which prevent the ice cubes from slipping off the plates complete the experiment kit.

Plate dimensions: approx. 95x95x13 mm³

P-1003497

Vane Wheel

Device for demonstrating air and heat flows generated by a burning candle, water vapour or other heat sources. Made of Aluminium and mountable on a long needle.

P-1003101

Additionally required:

Long needle

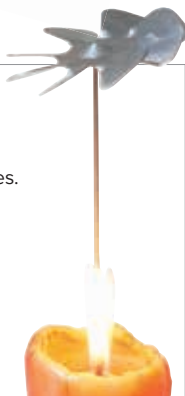

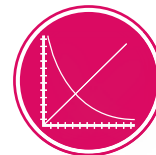

UE2020200
PDF online

Measure the heat radiated by a Leslie Cube

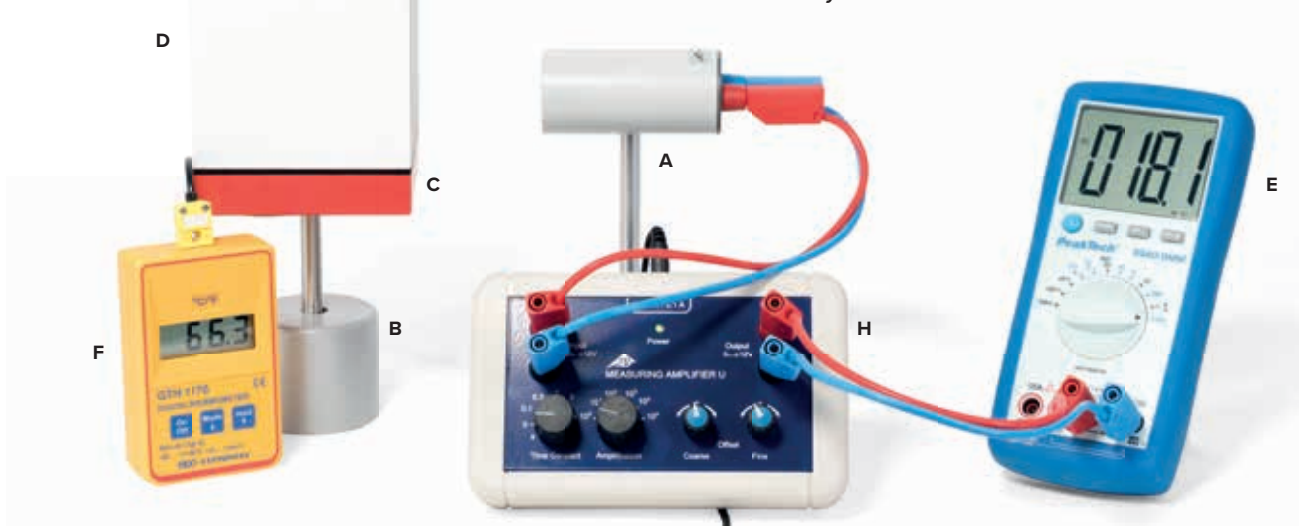

A. Moll Type Thermopile

Sensitive probe for measuring heat radiated by a black body or Leslie's cube, as well as for detecting visible light and ultraviolet radiation. Comprises a metal housing with a polished, conical reflector and a black surface 15 mm in diameter with 17 linked thermocouples. With two 4 mm connectors mounted on a stem.

Sensitivity: approx. $0.14 \mu\text{V}/\mu\text{WW}$
 Internal resistance: approx. 1Ω
 Setting duration: 40 s for 95% of the measured value
 Rod: approx. $156 \text{ mm} \times 10 \text{ mm}$ diam.
 Dimensions: approx. $94 \text{ mm} \times 40 \text{ mm}$ diam.
 Weight: approx. 200 g

P-1000824

Additionally required:

P-1013527 Analogue Multimeter ESCOLA 100 (not shown)

B. P-1001046 Barrel Foot

2 Experiment leads

Equipment:

A. P-1000824 Moll Type Thermopile

B. P-1001046 Barrel Foot, 500 g (2x)

C. P-1017875 Rotating Base for Leslie cube

D. P-1000835 Leslie's Cube

E. P-1002785 Digital Multimeter P3340

F. P-1002803 Digital Quick Response Pocket Thermometer

G. P-1002804 K-Type NiCr-Ni Immersion Sensor, $-65^\circ\text{C} - 550^\circ\text{C}$

P-1002849 Pair of Safety Experiment Leads, 75 cm (2x)

P-1002603 Pocket Measuring Tape, 2 m

H. P-1020742 Measurement Amplifier U (230 V, 50/60 Hz)

or

P-1020744 Measurement Amplifier U (115 V, 50/60 Hz)

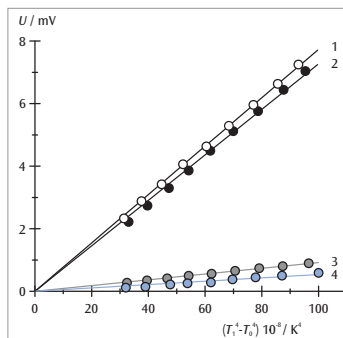

1: White surface

2: Black surface

3: Matte surface

4: Shiny surface

Radiated intensity from a Leslie Cube as a function of $x = T^4 - T_0^4$

C. Rotating Base for Leslie Cube

Plastic platform for Leslie Cube. With rotating bearing on stand rod. Includes felt strips for thermal insulation purposes.

Dimensions: approx. $100 \times 100 \text{ mm}$

Stand rod: approx. $120 \text{ mm} \times 10 \text{ mm}$ diam.

P-1017875



D. Leslie's Cube

A hollow aluminium cube for investigating heat radiation from a hot body as a function of its temperature and surface. With a removable lid for pouring in hot water and 2 openings for inserting a thermometer or thermal sensor and a stirrer. One side each is polished, matte, black and white.

Dimensions: approx. $100 \times 100 \times 100 \text{ mm}^3$

Weight: approx. 360 g

P-1000835



Additionally required:

A. P-1000824 Moll Type Thermopile



UE4050200
PDF online



Stefan-Boltzmann Lamp

High temperature source designed to produce thermal radiation, for investigating how such radiation depends on the temperature and to confirm the Stefan-Boltzmann law. The tungsten filament represents a good approximation of a point source of heat radiation and is thus highly suitable for investigating the inverse square law. The temperature of the lamp can be determined from the resistance of the filament. To minimise voltage loss, the lamp contacts are soldered to the connectors.

Nominal voltage:	12 V DC
Nominal current:	1.75 A
Nominal power:	21 W
Max. operating parameters:	13 V DC/2 A
Maximum temperature of filament:	3600 K

Contents:

1 Stand rod, 130 mm long
1 Stefan-Boltzmann lamp

P-1008523

Additionally recommended:

P-1003312 DC Power Supply 20 V, 5 A (230 V, 50/60 Hz)
or

P-1003312 DC Power Supply 20 V, 5 A (115 V, 50/60 Hz)

P-1003034 Storage Rail

P-1000824 Moll Type Thermopile

P-1002785 Digital Multimeter P3340 (3x)

Crookes Radiometer

Device for demonstrating the conversion of radiation energy into kinetic energy. Rotary-vane wheel mounted on a metal tip and equipped with four plates, each coloured black on one side; housed in an evacuated glass bulb.

Height: approx. 210 mm
Ball diameter: approx. 80 mm

P-1002882



Experiment Topics:

- Introduction to thermal radiation
- Stefan-Boltzmann law



UE2020205
PDF online



Advantages

- Regulated electric heater with 150 W lamp
- Easy adjustment and display of actual and set-point temperatures
- No naked flame and no hot water required
- The cube can be turned, ensuring all surfaces are equidistant from the thermopile
- No additional stands needed

Leslie Cube with Heater

Hollow cube made of aluminium for quantitative analysis of thermal radiation from a hot body as a function of temperature and the nature of the surface. Rotatable cube with built-in 150-W lamp and integrated temperature sensor for regulated heating of surfaces to a variable temperature. With holder for thermopile. One side each is plain, matt, white or painted black.

Heater power:	150 W
Max. temperature:	120°C
Resolution:	1°C
Display:	Two rows for actual and set-point temperatures
Dimensions:	approx. 250x250x220 mm ³
Weight:	approx. 1.8 kg

Leslie Cube with Heater (230 V, 50/60Hz)
P-1017730

Leslie Cube with Heater (115 V, 50/60Hz)
P-1017729

Additionally required:

P-1000824 Moll Type Thermopile

Experiments on Heat Conduction and Electrical Conduction

Experiments on Heat Conduction and Electrical Conduction.
Determination of electrical conductivity of copper and aluminium.

Quantity / Designation	Art. No.
1 Thermal conduction rod, Cu	P-1017330
1 Thermal conduction rod, Al	P-1017331
1 Measurement amplifier U (230 V, 50/60 Hz)	P-1020742
or	
1 Measurement amplifier U (230 V, 50/60 Hz)	P-1020744
1 DC power supply, 0 – 20 V, 0 – 5 A (230 V, 50/60 Hz)	P-1003312
or	
1 DC power supply, 0 – 20 V, 0 – 5 A (115 V, 50/60 Hz)	P-1003311
1 Digital multimeter	P-1002781
1 Set of experiment leads, 75 cm	P-1002841

Investigation of heat conduction in copper and aluminium in dynamic and static states

Quantity / Designation	Art. No.
1 Heat conducting rod, Cu	P-1017330
1 Heat conducting rod, Al	P-1017331
1 Heat conduction equipment set	P-1017329
1 DC power supply, 0 – 20 V, 0 – 5 A (230 V, 50/60 Hz)	P-1003312
or	
1 DC power supply, 0 – 20 V, 0 – 5 A (115 V, 50/60 Hz)	P-1003311
2 Digital multimeters	P-1002781
1 Digital thermometer, 2 channel	P-1002794
1 Set of experiment leads, 75 cm	P-1002841

Heat Conduction Equipment Set

Equipment set for investigating the heat conducting capabilities of metals in complete safety. The equipment set consists of an electronically regulated heat source for warming up a heat conducting rod, an insulating sleeve to reduce loss of heat to the surroundings and improve the linearity of the temperature profile, plus cooling baffles which can be used to radiate heat away from the apparatus. With a voltmeter and ammeter connected, it is possible to determine the electric power supplied to achieve the heating.

Maximum heating capacity:	approx. 43 W
Maximum heat loss:	4.5 W
Temperature of heat source:	105°C
Operating voltage:	12 V DC
Maximum heating current:	3.6 A

Includes:

- 1 Heating module
- 1 Insulating sleeve
- 1 Cooling baffle (heat sink)
- Heat conducting paste

P-1017329

Additionally required:

P-1017331 Heat Conducting Rod, Aluminium

or

P-1017330 Heat Conducting Rod, Copper

P-1017579 Table-Top Power Supply

or

P-1003312 DC Power Supply, 0 – 20 V, 0 – 5 A (230 V, 50/60 Hz)

or

P-1003311 DC Power Supply, 0 – 20 V, 0 – 5 A (115 V, 50/60 Hz)

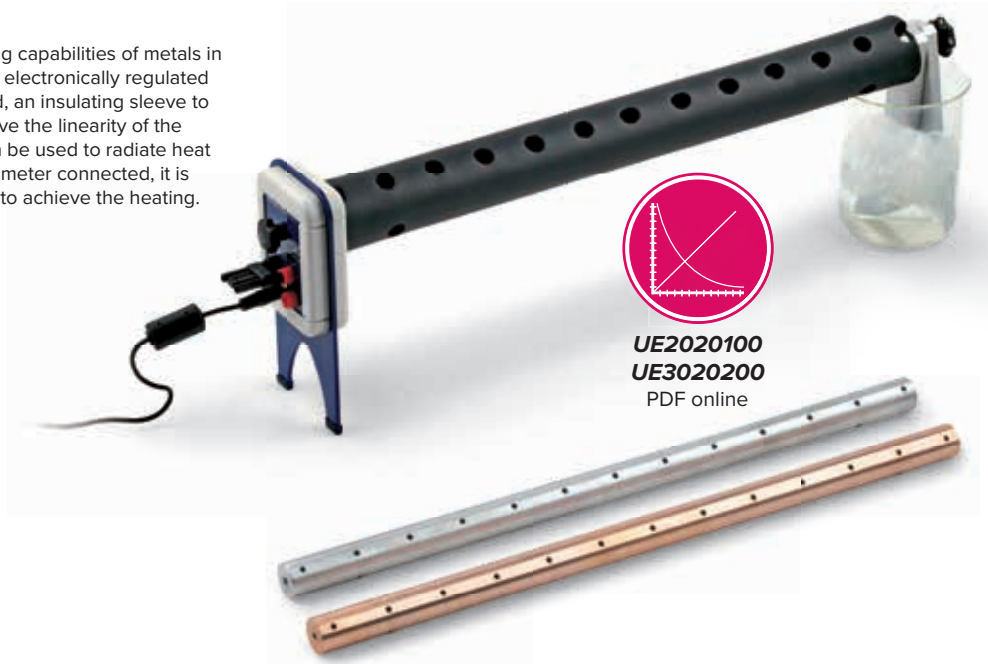

UE2020100
UE3020200
PDF online

Heat Conducting Rods

Heat conducting rods for investigating heat conductivity in conjunction with the heat conduction rods equipment set or for investigating electrical conductivity with the help of four-wire measurement.

Length:	500 mm
Cross sectional area:	490 mm ²
Measuring points:	13
Distance between measuring points:	40 mm
Heat conductivity (Al):	236 Wm ⁻¹ K ⁻¹
Heat conductivity (Cu):	240 – 380 Wm ⁻¹ K ⁻¹

Heat Conducting Rod, Al
P-1017331

Heat Conducting Rod, Cu
P-1017330



Table-Top Power Supply

Table-top power supply for supply of power to the heat conduction equipment set.

Mains voltage:	100 – 240 V AC/1 A, 50/60 Hz
Output voltage:	12 V DC/4 A

P-1017579



Advantages

- Easily understood, transparent design allows the sequence of movements to be viewed simply
- Durability and high precision thanks to use of high-quality materials

Steam Engine G

Transparent steam engine for demonstrating how an oscillating steam engine operates. In this engine the cylinder moves around a centre axis. This motion causes the inlet port and outlet port of the steam conduit to open and close. The base plate and flywheel are made of acrylic glass, while the boiler and working cylinder are made of heat proof quartz glass, making all of the moveable parts and actions very clearly visible. With a ball bearing supported crankshaft made of brass and a safety valve built into the boiler to prevent excessive pressure. Includes spirit burner with adjustable wick for use as heat source.

Rotation speed:	800 rpm
Mech. Power:	1 W
Boiler volume:	50 ml
Run time per load:	20 – 25 min
Max. operating pressure:	0.5 bars
Dimensions:	approx. 260x170x110 mm ³

P-1002597

Dry Fuel for Steam Engine B (not shown)

20 Esbit fuel tablets for heating water in steam engine B (P-1012801).

P-1012886

Oil for Steam Engine (not shown)

Oil for lubricating pistons, cylinders and all other bearings of the B-model steam engine (P-1012801).

P-1012887



Steam Engine B

Steam engine model for demonstrating a cycle where the working substance (water and steam) changes phase. Includes a fixed brass cylinder which operates in both directions with a flywheel and drive wheel also operating in both directions, plus a centrifugal governor and a steam-jet oiling mechanism. Highly polished, nickel-coated brass boiler with an inspection window to show the water level, a spring safety valve and a domed steam whistle. The brass boiler is fitted onto old-copper-coloured boiler housing with a brick pattern and a chimney. The water is heated using dry fuel. A tray for collecting condensed water is located under the chimney, allowing it to “smoke” like a real steam train.

Base:	260x200 mm
Height:	240 mm
Flywheel:	70 mm diam.
Boiler:	115x45 mm diam.
Boiler volume:	155 ml
Capacity:	approx. 120 ml
Weight:	approx. 1.3 kg

P-1012801

Qualitative Observations

- Liquid and gaseous states
- Dynamic compression and expansion
- Formation of the transition point at various temperatures

Quantitative Measurements

- Display of the critical point and temperature
- Recording of isotherms in p-V (Clapeyron) diagrams
- Recording of isotherms in pV-p (Amegat) diagrams
- Pressure curves for a saturated vapour
- Differences between real gases and ideal gases

Critical Point Apparatus

A high-precision apparatus for studying the compression and liquefaction of a gas, determining the critical point and recording isotherms in p-V (Clapeyron) diagrams. The test gas is sulphur hexafluoride (SF_6), which has a critical temperature of 318.6 K (45.5°C) and a critical pressure of 3.76 MPa (37.6 bars), allowing for a simple experiment set-up. The apparatus includes a transparent measuring cell that is highly resistant to leakage and compression. The volume inside the cell is changed via a finely adjustable handwheel, the change being indicated by a combination of a fixed and a rotary scale to an accuracy of $\frac{1}{10000}$ of the maximum volume. The pressure is generated by a hydraulic system containing castor oil of medically approved quality. The measuring cell and hydraulic system are separated by a cap seal which rolls in as the volume increases. This design means the pressure gradient between the measuring cell and oil chamber is negligible. A manometer measures gas pressure instead of oil pressure without taking up any dead space inside the measuring cell. During transitions from the gaseous to the liquid phases and vice versa, it is therefore possible to observe the formation of the first drops of liquid and disappearance of the last gas bubbles. The measuring cell is enclosed in a transparent water chamber. A circulation thermostat allows the temperature to be maintained at a highly constant value, which can be monitored by means of a thermometer. Practical indications of the volume, pressure and temperature permit easy recording of p-V or pV-p diagrams providing qualitatively correct results. Pressure and temperature-dependent volumetric corrections also provide quantitatively accurate results comparing favourably with standard reference values.

Critical temperature:	318.6 K (45.5°C)
Critical pressure:	3.76 MPa (37.6 bars)
Critical volume:	197.4 cm ³ /mol
Critical density:	0.74 g/mol
Temperature range:	10 – 60°C
Maximum pressure:	6.0 MPa (60 bars)
Maximum volume:	15.7 cm ³
Manometer diameter:	160 mm
Bore for temperature sensor:	6 mm diam.
Temperature control connections:	7 mm diam.
Reducing valve connection:	$\frac{1}{8}$ " diam.
Standard gas connection:	3.5 mm diam.
Dimensions:	approx. 380x200x400 mm ³
Weight:	approx. 7 kg

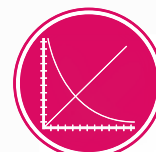
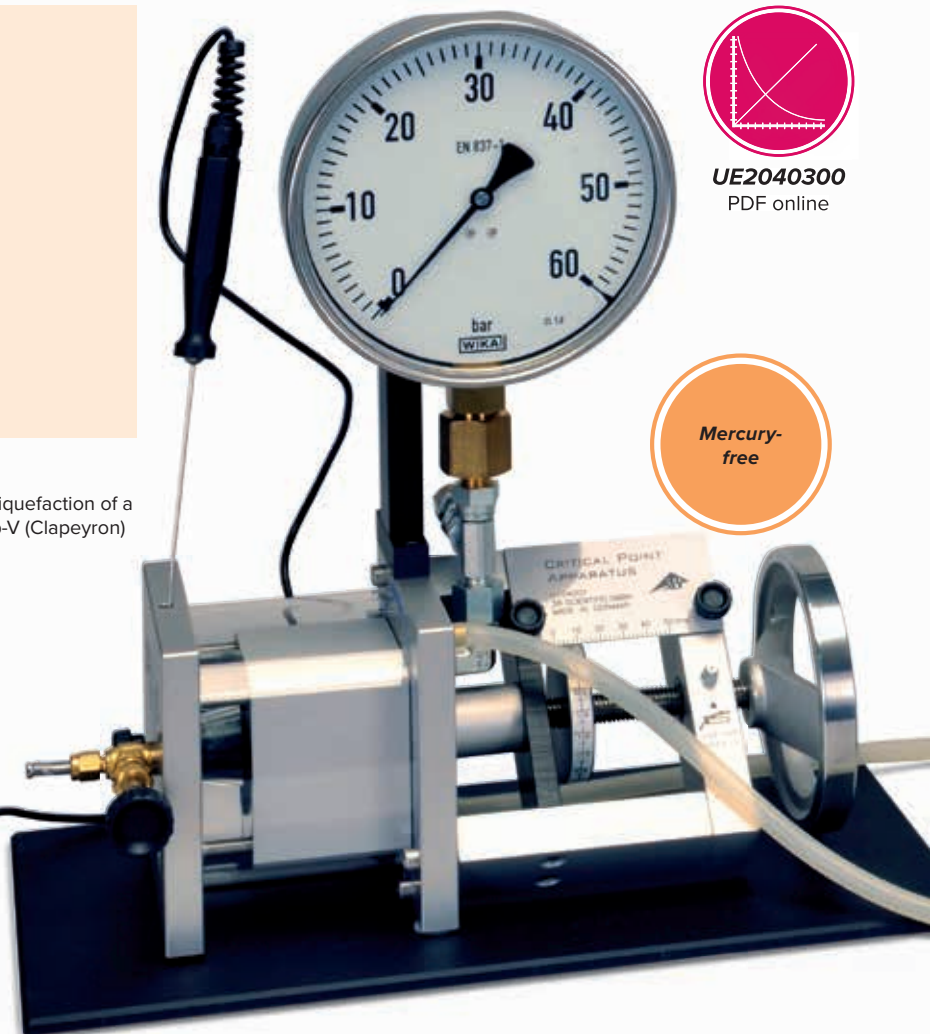

UE2040300
PDF online

Mercury-free

Contents:

- 1 Critical point apparatus filled with hydraulic (castor) oil but without test gas (SF_6). Includes built-in safeguarded connection nozzle for MINICAN® gas canisters
- 1 Oil filling device
- 1 Angled 1.3-mm hexagonal spanner (for grub screw on rotary scale)
- 1 Plastic hose, 3 mm internal diameter
- 1 $\frac{1}{8}$ " pipe screw connection (SW 11)
- 1 Grease gun

P-1002670

Additionally required:

- P-1008654 Immersion/Circulation Thermostat (230 V, 50/60 Hz) or
- P-1008653 Immersion/Circulation Thermostat (115 V, 50/60 Hz)
- P-1002622 Silicone tubing, 1 m (2x)
- P-1002803 Digital quick-response pocket thermometer
- P-1002804 Immersion Sensor, NiCr-Ni, type K, -65°C – 550°C
- Sulphur hexafluoride SF_6

Additionally required in case of degassing hydraulic oil:

- P-1002671 Castor Oil
- High-Power Vacuum Pump



Immersion/Circulation Thermostat

Immersion circulation thermostat for setting the temperature of a bath or external apparatus with non-flammable liquids at temperatures up to 95°C. The fully electronic continuous regulator and the powerful circulating pump ensure that the water in the bath is optimally stirred so that the temperature remains highly constant. The user-friendly menu and simple three-button operation guarantee that the equipment is easy to use. A single-row LED display indicates the desired temperature and the actual temperature. Excess temperature protection is set to a fixed value of 95°C and features both audible and visual alarms to enhance operating safety. Also included is the possibility of connecting a water cooler or heat exchanger to provide cooling by means of tap water.

Operating-temperature range:	25°C – 100°C
Temperature constancy:	±0.05°C
Heating power:	1.5 kW
Pump pressure:	max. 0.2 bar
Delivery rate:	max. 15 l/min
Bath volume:	max. 5.5 l
Bath area / depth:	approx. 145x161x150 mm ³

**Immersion/Circulation Thermostat (230 V, 50/60 Hz)
P-1008654**

**Immersion/Circulation Thermostat (115 V, 50/60 Hz)
P-1008653**

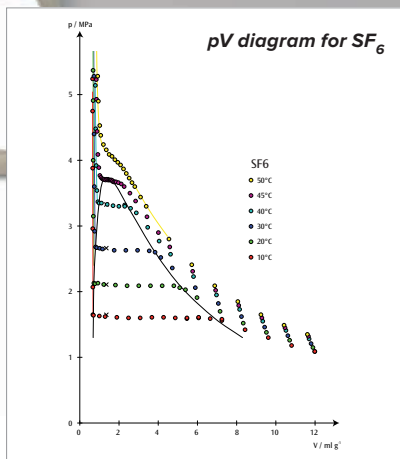

Note:
In accordance with good laboratory practice, it is advisable to obtain gas via a fixed pipeline if the critical-point apparatus is used frequently. In case of occasional usage, it is more expedient to obtain the test gas from MINICAN® canisters. A MINICAN® gas connection is designed similarly to the valve on a common spray can, i.e. it is opened simply by fitting the MINICAN® on the gas connection nozzle.

Set of Seals (not shown)

Set of spare seals for critical point apparatus (P-1002670). Includes a rubber cap seal, round rubber seal of diameter 60 mm, square rubber seal 78x78 mm², a sealing ring of diameter 30/20 mm, four copper sealing discs and a threaded bush made of POM (Polyoxymethylene).

P-1002672

Castor Oil (not shown)

100 ml of DAB approved castor oil for filling critical point apparatus (P-1002670).

P-1002671

Accessories for Kinetic Gas Theory

Accessories for vibration generator (P-1000701) for simulating particle motion in an ideal gas. Differently coloured spheres (gas model) are set in motion by mechanical vibrations.

Contents:

- 1 Plexiglas cylinder, length 300 mm
- 1 Circular disc
- 1 Set of spheres of different colours

P-1000704

Additionally required:

P-1000701 Vibration Generator
P-1009957 Function Generator
FG 100 (230 V, 50/60 Hz)

or

P-1009956 Function Generator
FG 100 (115 V, 50/60 Hz)



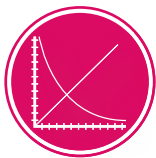

UE2040100
PDF online

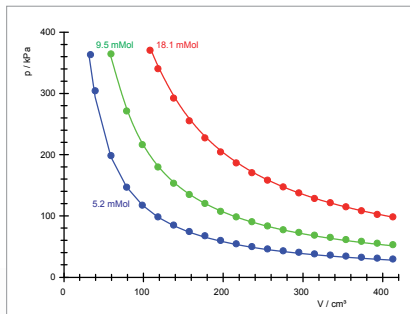

Pressure-volume diagram



Boyle's Law Apparatus

Apparatus for determining experimentally the relationship between gas volume and pressure at constant temperature (Boyle's law). The working cylinder is made of transparent acrylic and has a moving piston, scale and manometer. Along with a valve to let in gas or release it. The movement of the piston is achieved with the help of a threaded connecting rod turned by means of a manual crank. In this way, pressure both above and below atmospheric can be generated. For safety reasons, the working cylinder is enclosed in another protective transparent acrylic cylinder.

- Length: 300 mm
- Internal diameter: 40 mm
- Piston: 30 mm x 40 mm diam.
- Piston sealing: 2 ring gaskets
- Manometer diameter: 100 mm
- Permitted pressure: max. 4 bar

P-1017366

Jolly's Bulb and Gauge

Palm-sized, hollow metallic ball with a manometer connected to it for demonstrating change of pressure in a closed volume of air when heated or cooled. Immersing the ball in a water bath at a specific temperature allows the relationship between pressure and temperature of the enclosed air to be investigated in order to demonstrate the behaviour of an ideal gas.

- Hollow ball: 60 mm diam.
- Manometer: 840 – 1240 hPa

P-1012870



Oscillation Tube

For determining adiabatic exponent c_p/c_v of air by Rüchardt's method, used in conjunction with Mariotte flask (P-1002894). Precision glass tube with precisely fitting aluminium cylinder. If the glass tube is placed vertically on a glass flask of 10 l volume and the aluminium cylinder is allowed to slide into the glass tube, it can be made to undergo harmonic oscillations on the air cushion resulting from the enclosed volume of air. c_p/c_v can then be calculated from the period.

- Dimensions: 600 mm x 16 mm diam.
- internal Aluminium cylinder: 15.2 g

P-1002895

Additionally required:

- P-1002894** Mariotte Flask
- P-1002811** Digital Stopwatch

Additionally recommended:

- P-1012856** Vacuum Hand Pump

Mariotte Flask

Duran glass flask with discharge opening at base and two rubber stoppers with boreholes.

Volume: 10 l

P-1002894

Additionally recommended:

- P-1002895** Oscillation Tube



Pneumatic Lighter

Device for demonstrating the ignition of diesel. By swiftly pressing down the piston, the compressed air in the transparent tube is heated so strongly that a piece of paper placed at the bottom of the tube very clearly ignites. Similarly, a cotton-wool pad soaked in ether also catches fire.

- Length of compression tube: approx. 150 mm

P-1003569

Spare Tube for Pneumatic Lighter (not shown)

Spare tube for pneumatic lighter (P-1003569).

P-1003570

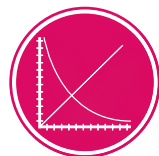
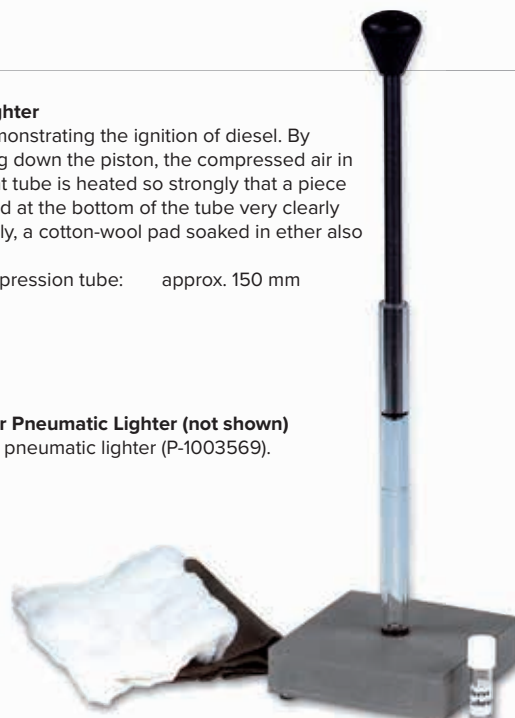

UE2040200
PDF online

Experiment Topics:

- Recording and evaluating a pV diagram
- Operation of a Stirling engine as a heat pump or refrigerator
- Operation of a Stirling engine as a classical heat-engine

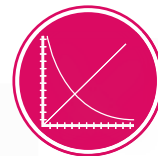

UE2060250
PDF online



Advantages

- Durability and high precision thanks to the use of high-quality materials
- Easily understood, transparent design allows the functioning to be viewed with ease
- Featuring built-in generator unit

Stirling-Engine G

Transparent Stirling engine for quantitative investigations of the Stirling cycle, as a heat engine, heat pump and refrigerating machine. The displacement cylinder and displacement piston are made of heat resistant glass; the power cylinder, flywheel and gearbox cover are made of acrylic glass. This allows very clear observation of the individual sequences of motion at all times. The crankshafts have ball bearings and are made of hardened steel. The connecting rods are made of wear resistant plastic. Includes spirit burner with adjustable wick for use as a heat source. The glass of the displacement cylinder is also equipped with recessed temperature measurement sockets before and behind the displacement piston, to allow measurements of temperature differences during operation as a heat pump or refrigerating machine. The large flywheel made of acrylic glass has imprinted markings to allow measurement of revolutions per unit of time using a light barrier. For recording pV-diagrams, it is possible to measure the pressure in the power cylinder via a hose connection; the string included in the scope of delivery can be fastened to the power piston to measure the stroke in order to determine the volume. The integrated engine generator unit with a two stage belt pulley allows a conversion of the produced mechanical energy into electrical energy. Equipped with a switchover option for operating an integrated lamp or external loads, or feeding electrical energy for operation as a heat pump or refrigerating machine, in accordance with the direction of rotation of the Stirling engine.

Power of the Stirling engine:	1.5 W
Idling speed:	1000 rpm
Flywheel:	140 mm diam.
Power cylinder:	25 mm diam.
Stroke of the power piston:	24 mm
Gas volume:	32 cm ³ – 44 cm ³
Motor generator unit:	max. 12 V DC
Belt pulley:	two stage (30 mm diam., 19 mm diam.)
Dimensions:	approx. 300x220x160 mm ³
Weight:	approx. 1.6 kg

P-1002594

Additionally recommended:

P-1021533 Relative Pressure Sensor FW ± 1000 hPa

P-1021534 Displacement Sensor FW

P-1008500 Sensor Holder for Stirling Engine G

P-1021477 VinciLab

Software Coach 7

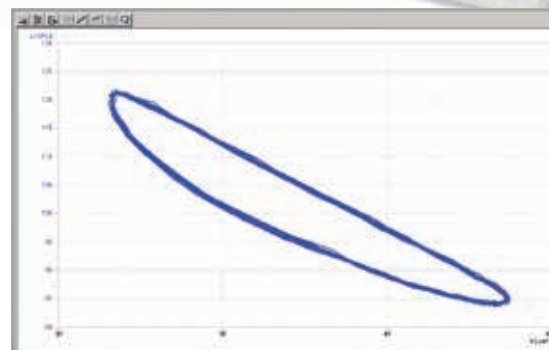
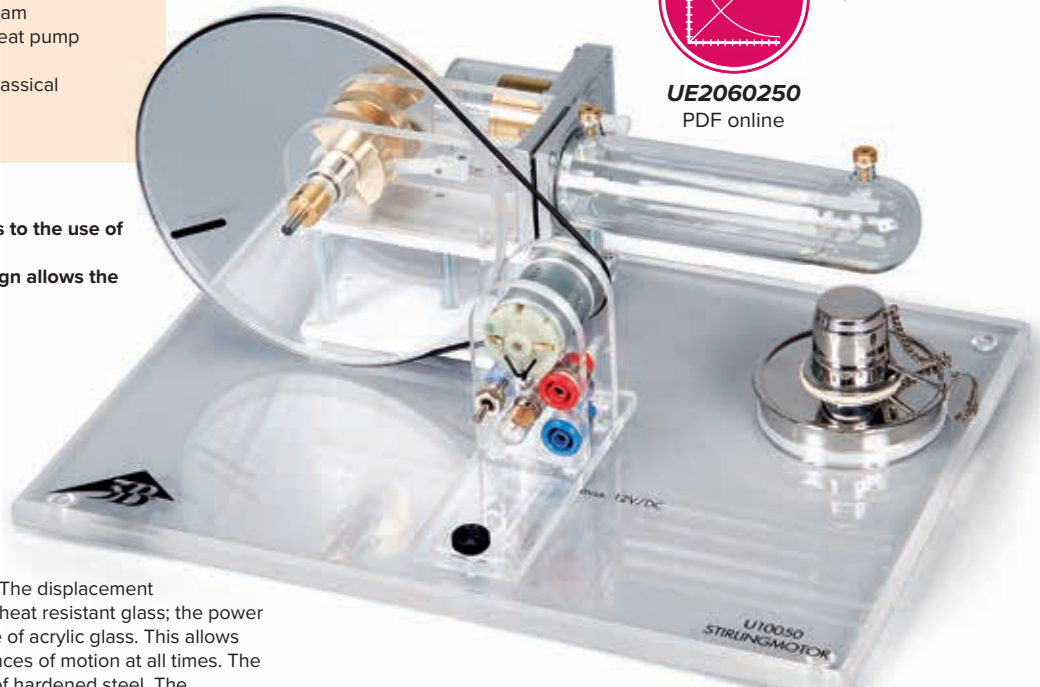

Pressure-volume diagram of Stirling engine G

Sensor Holder for Stirling Engine G

Holder for the relative pressure sensor FW (P-1021533) and the displacement sensor FW (P-1021534) for use with the G-series Stirling engine (P-1002594).
P-1008500

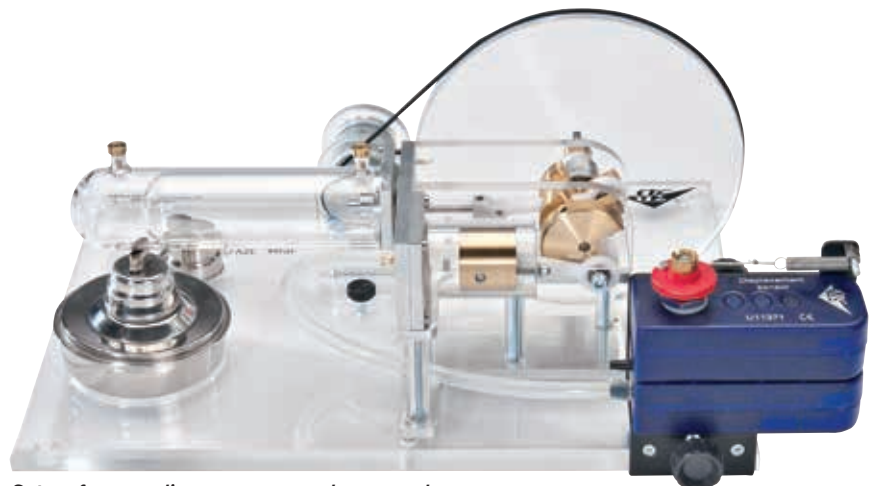

Set-up for recording a pressure-volume graph

Experiment Topics:

- Operation of a Stirling engine as a classical heat-engine
- Measurement of the no-load (idling) rate of rotation as a function of the heat input
- Recording and evaluating a pV diagram



Advantages

- **Slow running allows for the interaction between the displacement piston and working piston to be observed easily**
- **Discontinuous motion of the piston provides for almost perfect p-V (pressure-volume) diagrams**
- **It is possible for the system to be heated by absorption of radiant heat**

Stirling Engine D

A functional model of a Stirling engine based on an idea by Professor Wilcke optimised for demonstrating to students the conversion of thermal energy into mechanical energy and the operation of a thermal engine, as well as investigating the Stirling cycle. The interplay between the displacement piston and the power piston can be seen especially clearly at a low rate of rotation. In this version the displacement piston moves discontinuously, with a dwell time during the heating of the working medium (air) and a second dwell time during its cooling. This offers a clearer demonstration of the ideal Stirling cycle than is possible with continuous piston movement. The heat source can be provided by an integrated electric hotplate, a candle flame, or focused adiation from the sun or from a lamp. In the latter case the direction of rotation will depend on whether the heat is applied from above or from below. For recording pV diagrams, the pressure can be measured via a rubber hose connection on the power cylinder, and the volume can be measured by attaching a thread to the power piston to follow its movement.

Heater voltage: 8 – 12 V, 1.5 A
Gas volume: 330 cm³ – 345 cm³
Flywheel rod: 400 mm
Dimensions without flywheel rod: approx. 260x185x330 mm³
Weight: approx. 2.2 kg

P-1000817

Additionally recommended:

P-1021532 Relative Pressure Sensor FW ± 100 hPa
P-1021534 Displacement Sensor FW
P-1008516 Supplementary Set for Stirling Engine D
P-1021477 VinciLab
Software Coach 7

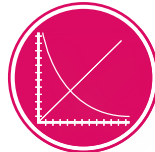
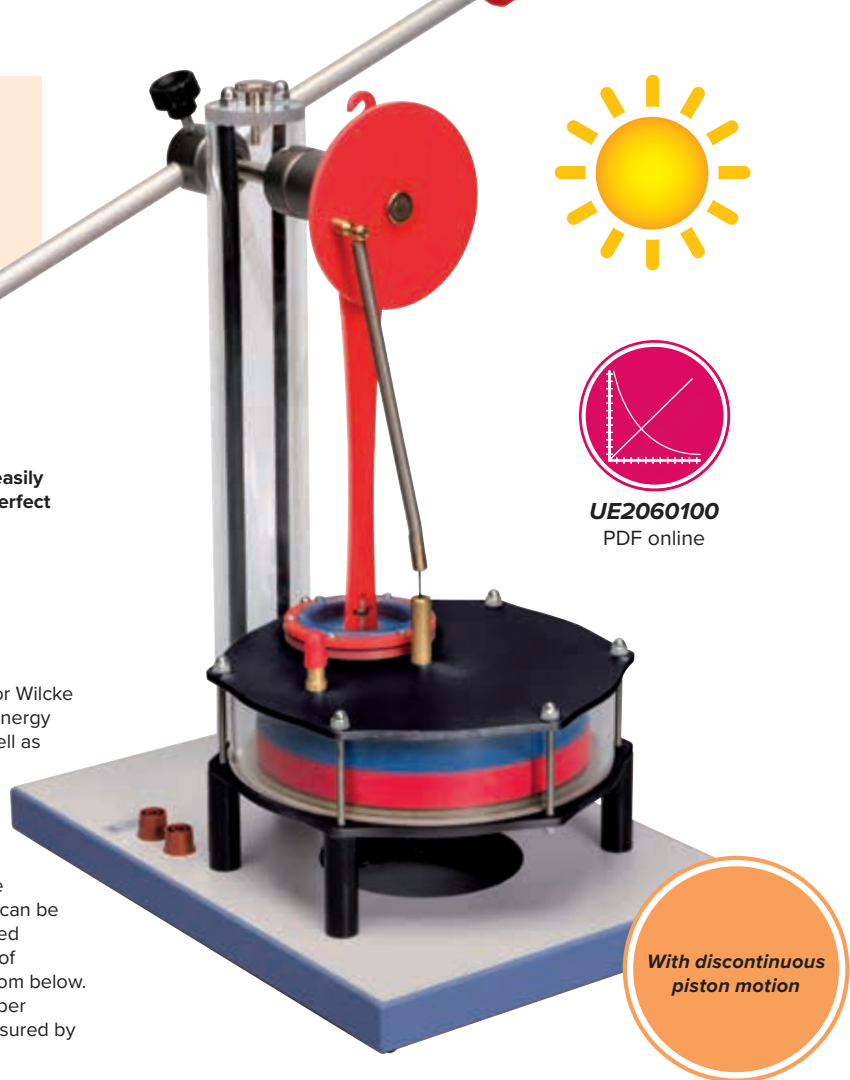

UE2060100
PDF online

With discontinuous piston motion

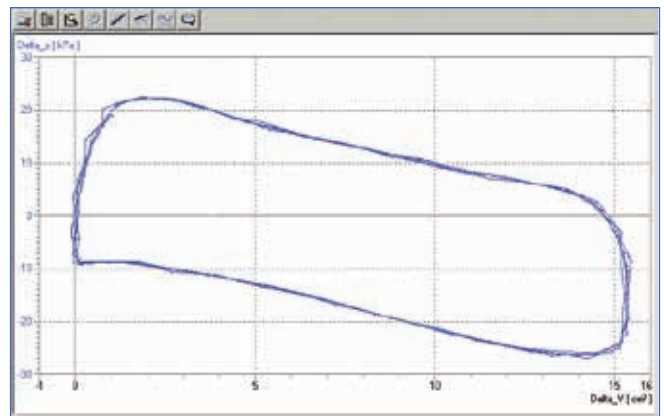

Pressure-volume diagram of Stirling engine D

Supplementary Set for Stirling Engine D

Set of equipment for adding a displacement sensor FW (P-1021534) and a relative pressure sensor FW (P-1021532) to the D-series Stirling engine (P-1000817).

The set consists of the following components:

- 1 Base plate to accommodate the pressure sensor
- 1 Knurled screw for fastening the base plate to a stand rod
- 1 Stem with magnetic base for displacement sensor
- 1 Silicone tubing for connecting ± 100 -hPa relative pressure sensor
- 1 Set of threads with suction pad
- 2 Weights with hook, 20 g each

P-1008516

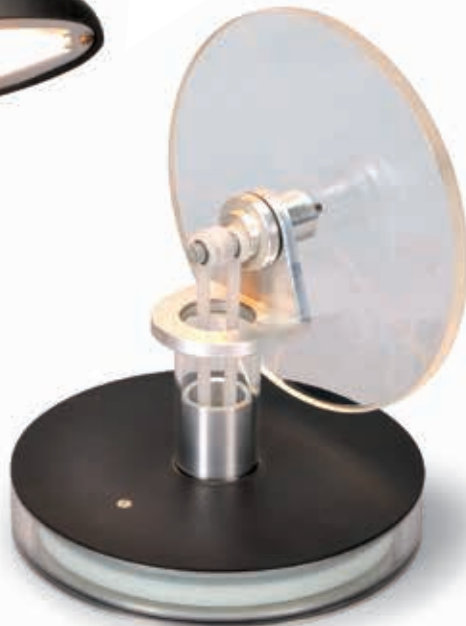

Advantages

- Runs with a temperature difference of just 5°C between the top and bottom plates
- Heat can be fed from below (e.g. heat from a human hand) or above (e.g. heat from the sun)
- Transparent components make it easy to view the functioning
- Also available in kit form

Low Temperature Stirling Engine

A compact, transparent Stirling engine for demonstrating the operation and fundamental design of such engines. A temperature difference of approximately 5° C between the base and top plates is sufficient to set the motor in motion. This difference can be generated just by the warmth of a human hand or by cooling through contact with a cold object from a refrigerator. The top plate's matt, black coat also enables the device to be operated as a solar-powered engine. In this case the direction of rotation will depend on whether the heat is applied from above or from below. The power cylinder is made of precision glass, while the displacement cylinder and flywheel are made of acrylic glass; this allows a clear observation of the movements of the power piston, displacement mechanism and crankshaft drive. The crankshaft and connecting rod have miniature precision ball bearings.

Rotation speed: 80 rpm at $\Delta T = 10^{\circ}\text{C}$
 Flywheel: 110 mm diam.
 Dimensions: approx. 138 mm x 110 mm diam.

P-1002598



Low Temperature Stirling Engine, Assembly Kit

P-1002599

Stirling Engine S

This affordable Stirling engine comes complete with built-in alcohol burner. Red flywheels and chassis mounted on a green base, this all-metal engine runs silently at speeds in excess of 1,000 rpm. The engine demonstrates the principle of the Stirling cycle and the functioning of a classical heat engine. It comes completely assembled and ready to run, accompanied by the book "Stirling Cycle Engines" which explains the principles of operation.

Rotation speed: 1000 rpm
 Base plate: approx. 180x110 mm²
 Weight: approx. 1.15 kg

P-1003505

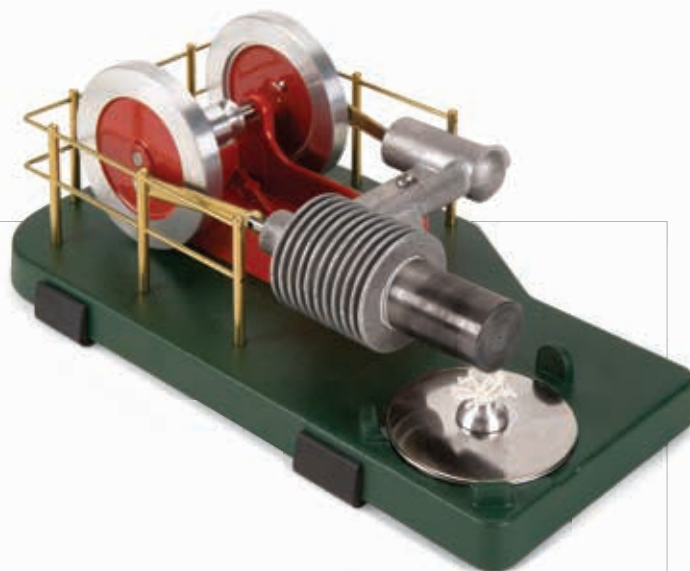



Advantages

- Very clear demonstration model with a compact and easily understood design
- The layout of the components matches the sequence of a heat cycle
- Inspection windows for observing how the refrigerant changes state

Experiment Topics:

- Determining the power output as a function of the temperature difference
- Analysing the cyclic process by means of a Mollier diagram

Heat Pump D

Demonstration model for showing how refrigerators and electrical compression heat pumps work. Consisting of compressor with drive motor, vaporiser, expansion valve and condenser. May be used as an air water or water water heat pump. Includes wattmeter, so that one can record the operation time, the mains voltage, instantaneous power input and electrical work. The components are connected in a closed system by copper pipes and mounted on a base board, and the clear layout makes it possible to directly relate the sequence of changes of state to the cyclic operation of the heat pump. Evaporator and condenser are constructed as copper tubing spirals and each of them is submerged in water filled containers serving as heat reservoirs for determining the heat absorbed or emitted. Two digital thermometers allow the necessary temperature measurements to be made in both water reservoirs. Two large manometers display the pressure ratios of the coolant in both heat exchangers. Two observation windows are provided for observing the state of aggregation of the refrigerant after the evaporator and after the condenser. A protective overpressure switch disconnects the compressor motor from the circuit when overpressure reaches 15 bars.

Compressor power: 120 W
 Coolant: R 134A, free of chloro-fluorohydrocarbons
 Temperature reservoirs: 2000 ml each
 Manometer: 160 mm diam.
 Dimensions: 560x300x630 mm³
 Weight: approx. 21 kg

Heat Pump D (230 V, 50 Hz)
P-1000820

Heat Pump D (115 V, 60 Hz)
P-1000819

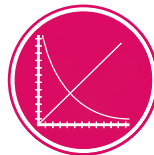
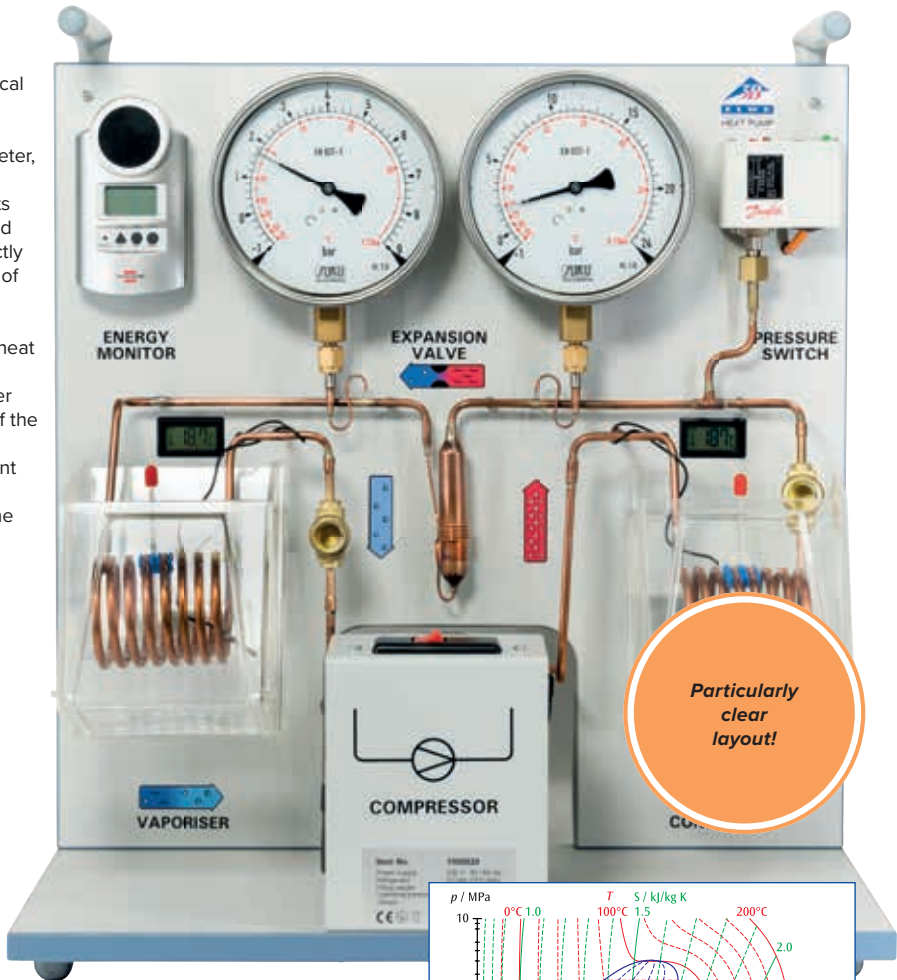

UE2060300
 PDF online

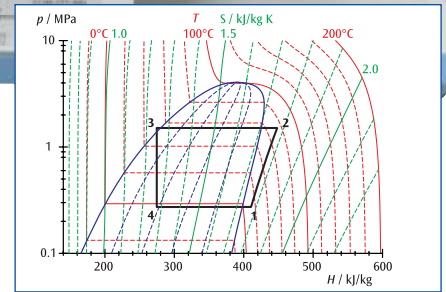

Pressure-enthalpy diagram of heat pump



Temperature Sensor, NTC with Measurement Terminal

Temperature sensor for the measurement of temperatures on the copper tubing of a heat pump (P-1000820 or P-1000819). Temperature sensor shaft made of rust-proof stainless steel. Tip with matching copper terminal. Can be used in conjunction with VinciLab unit (P-1021477) for manual measurements or for processing measurement data when connected to a computer. Includes connector lead.

Measurement range: -40 – 140°C
 Resolution: 0,1°C
 Accuracy: 2°C at -40°C; 0,6°C at 30°C; 1,8°C at 140°C
 Sensor type: NTC thermistor

P-1021797

Experiment Topics:

- Peltier heat pump in symmetrical and asymmetrical operation
- Recording of temperature over time during pumping and settling phases
- Heating, cooling and electrical power, power coefficient, efficiency
- Seebeck coefficient
- Peltier effect, Joule losses, heat reflux due to the conduction of heat by Peltier element
- Heat transfer and thermal conduction coefficients
- How the thermal voltage and operating voltage depend on the temperature difference

Peltier Heat Pump

Working model with aluminium water tanks which are thermally coupled to the surfaces of a Peltier element. When an electric current flows through the Peltier element, heat is transferred between the tanks, causing one of them to cool and the other to heat up. Each of the reservoirs has an electric stirrer to ensure even distribution of the heat. Two digital thermometers indicate the respective water temperatures. Since the specific heat capacity of the system is known, it is possible to determine the power involved in heating and cooling and for a comparison to be made with the electrical power supplied. The system is supplied in a handy transport case which also ensures sufficient thermal insulation from the surroundings.

Peltier element:

Supply voltage: 5 – 8 V
 Current consumption at 8 V: 2.5 – 3.5 A
 Surface area: 40x40 mm²
 Thickness: 3.7 mm

Water tanks:

Volume: 200 ml
 Weight: 105 g

Stirrer:

Current consumption: approx. 100 mA

Carrying case:

Dimensions: approx. 244x160x70 mm³
 Weight: approx. 920 g

P-1020769

Additionally required:

- P-1003312 DC Power Supply, 20 V, 5 A, (230 V, 50/60 Hz)
- or
- P-1003311 DC Power Supply ,20 V, 5 A (115 V, 50/60 Hz)
- P-1018832 Digital Multimeter
- P-1017718 Pair of Safety Experiment Leads (2x)

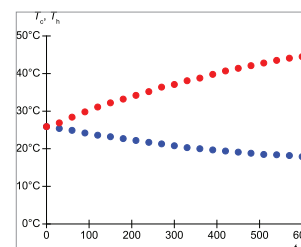
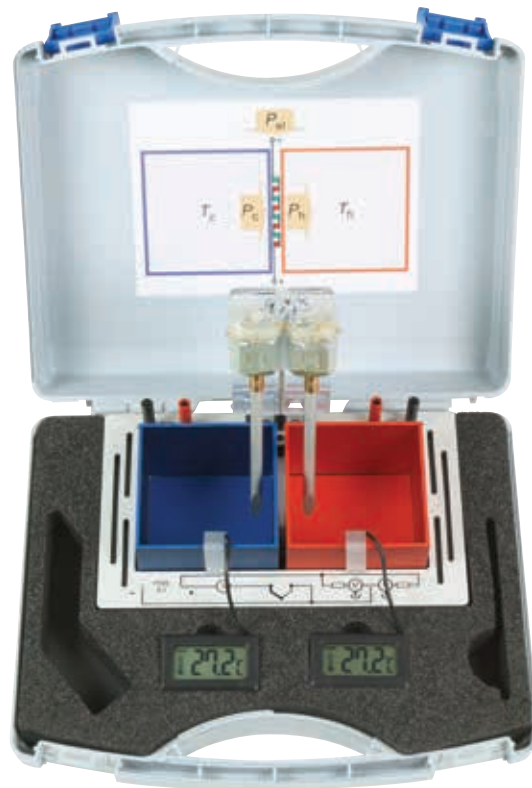

Change of temperature over time in both reservoirs during symmetrical operation.

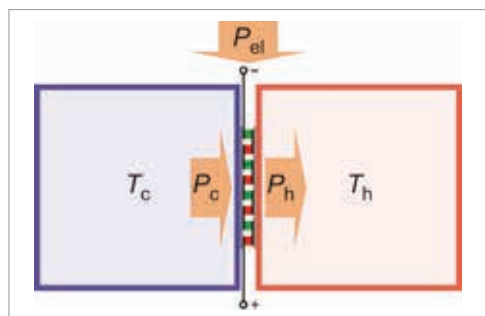

How a Peltier heat pump works

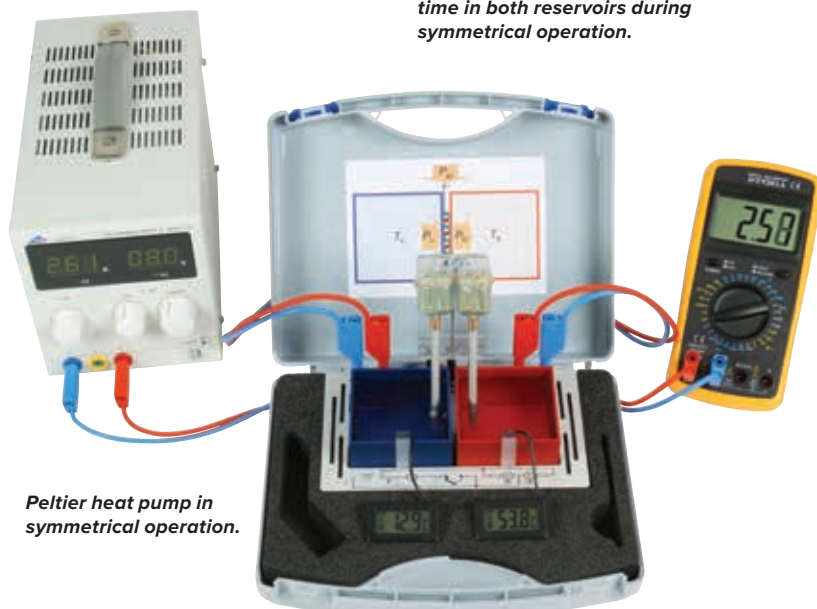

Peltier heat pump in symmetrical operation.

LIGHT AND OPTICS

Experiment Topics:

- Laws of reflection
- Laws of refraction
- Total reflection
- Minimum deflection angle for a prism
- Focal determination of mirrors and lenses
- Laws of lenses and image errors
- Shadow casting



Multiple-Ray Projector, Magnetic

Light source for experiments demonstrating ray optics on a whiteboard (P-1002591 or P-1002592). In metal housing on magnetic foil. Experiments on reflection, refraction and basic lens laws can be performed using five narrow light rays which emerge from the right-hand side. With the help of rotating mirrors, these rays can be directed to make parallel, divergent or convergent beams, or can be masked out individually. Highly demonstrative experiments on shadow casting can be conducted using the two divergent light rays emerging from the left-hand side. With the help of rotating mirrors, these rays can be directed or masked out individually.

Lamp: 12 V, 55 W
 Connecting line: 1.5 m long with 4 mm plug
 Dimensions: approx. 150x200x50 mm³
 Weight: approx. 0.9 kg

P-1003321

Additionally required:

P-1000593 Transformer 12 V, 60 VA (230 V, 50/60 Hz)
 or
P-1006780 Transformer 12 V, 60 VA (115 V, 50/60 Hz)

Halogen Lamp, 12 V, 55 W (not shown)

Spare halogen lamp for multiple-ray projector (P-1003321).
P-1003322



Advantages

- Ideally suited for demonstration experiments
- Experiments can be carried out without darkening the room
- Experiment set-ups and hand-written notes supplement one another to give an overall picture

Optics Kit for Whiteboard

Set of optical components for use in conjunction with a single-beam lamp (P-1000682) or multiple-beam lamp (P-1003321) on a whiteboard (P-1002591 or P-1002592). All components are lined with magnetic foil or furnished with a magnet holder and can be easily mounted and aligned on the whiteboard. This apparatus permits a wide range of experiments demonstrating ray optics without the need for a dark room; handwritten notes can be added to provide a clearer explanation.

P-1000604

Additionally required:

P-1002591 Whiteboard 600x900 mm²

or

P-1002592 Whiteboard 900x1200 mm²

P-1000682 Single-Ray Projector

P-1003323 Magnetic Holder for Single-Ray Projector

or

P-1003321 Multiple-Ray Projector



Contents:

Art. No.	Designation	Dimensions	Material
Mirrors:			
P-1002984	Plane mirror	200x35x35 mm ³	Plastic
P-1002985	Convex – concave mirror, $f = \pm 100$ mm	200x35x35 mm ³	Plastic
Transparent objects:			
P-1002986	Plano-concave lens, $f = -400$ mm	200x40x35 mm ³	Acrylic glass
P-1002987	Plano-convex lens, $f = +400$ mm	200x40x35 mm ³	Acrylic glass
P-1002988	Plane-parallel plate	200x100x35 mm ³	Acrylic glass
P-1002989	Semi-circular body, $f = +200$ mm	diam. 200x35 mm ²	Acrylic glass
P-1002990	Right-angled prism	200x200x35 mm ³	Acrylic glass
Shadow-casting bodies:			
P-1002992	Cuboid	100x20x35 mm ³	Plastic
	Cylinder	diam. 5x35 mm ²	Plastic
	Cylinder	diam. 60x35 mm ²	Plastic

Whiteboards

Metal board with enamelled surface for demonstration experiments using magnetic components, e.g., for mechanics or optics. Scratch and acid resistant steel board that can be written on using water soluble pens. Wall mounted.

Art. No.	Designation	Dimensions
P-1002591	Whiteboard	600x900 mm ²
P-1002592	Whiteboard	900x1200 mm ²



Single-Ray Projector

Light source for experiments demonstrating ray optics on a whiteboard (P-1002591 or P-1002592). With an adjustable aperture for producing a concentrated or divergent light beam.

Lamp: 12 V, 35 W
 Connecting line: 1.5 m long with 4 mm plug
 Dimensions: approx. 120 mm x 70 mm diam.
 Weight: approx. 0.25 kg

P-1000682

Additionally required:

P-1003323 Magnetic Holder for Single-Ray Projector

P-1000593 Transformer 12 V, 60 VA (230 V, 50/60 Hz)

or

P-1006780 Transformer 12 V, 60 VA (115 V, 50/60 Hz)

Halogen Lamp, 12 V, 35 W (not shown)

Spare lamp for single-ray projector (P-1000682).

P-1003324

Magnetic Holder for Single-Ray Projector

Magnet holder for mounting single-beam lamp (P-1000682) on a white board (P-1002591 or P-1002592).

P-1003323

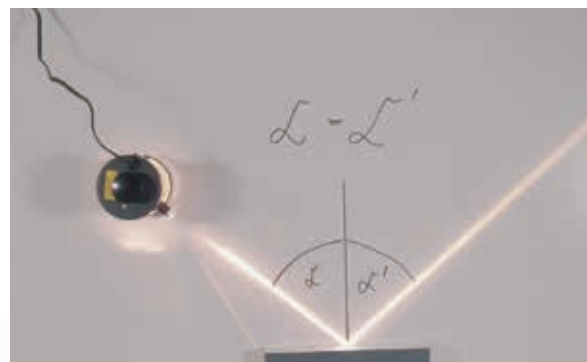

Reflection

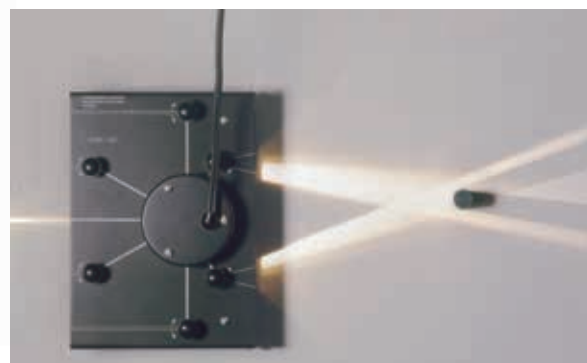

Shadow projection

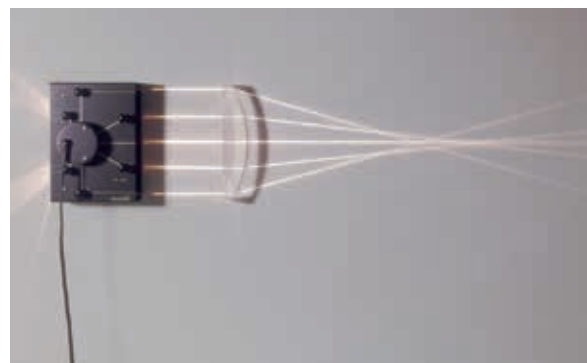

Lens errors

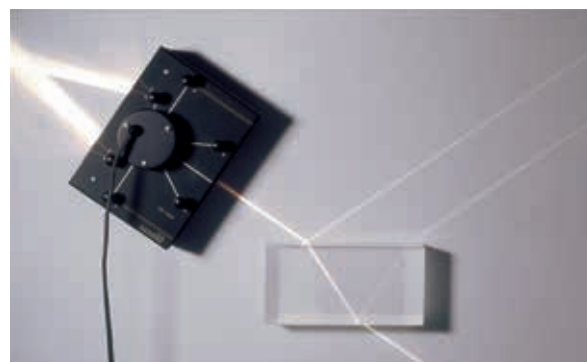

Refraction

Laser Ray Box

Laser diode capable of producing up to five parallel rays, for use with related board (P-1003056). In metal housing with magnetic foil. The number of emerging light beams can be selected electronically via switches. Power is supplied via a plug-in unit or batteries that are automatically disconnected after 60 minutes.

Diode laser: 5 beams, each max. 1 mW,
Laser safety class II
Wavelength: 635 nm
Separation of laser beams: 18 mm
Plug-in power supply: Primary 100 – 240 V AC,
Secondary 3 V DC, 300 mA
Battery compartment: for 2x 1.5 V AA-batteries
(batteries not included)
Dimensions: approx. 110x60x20 mm³

Laser Ray Box (230 V, 50/60Hz) P-1003052

Laser Ray Box (115 V, 50/60 Hz) P-1003051

Board for Laser Ray Box

Magnetic board for conducting experiments with laser ray box (P-1003052 resp. P-1003051). With a removable prop for inclining board.
Dimensions: approx. 600x450 mm²
P-1003056

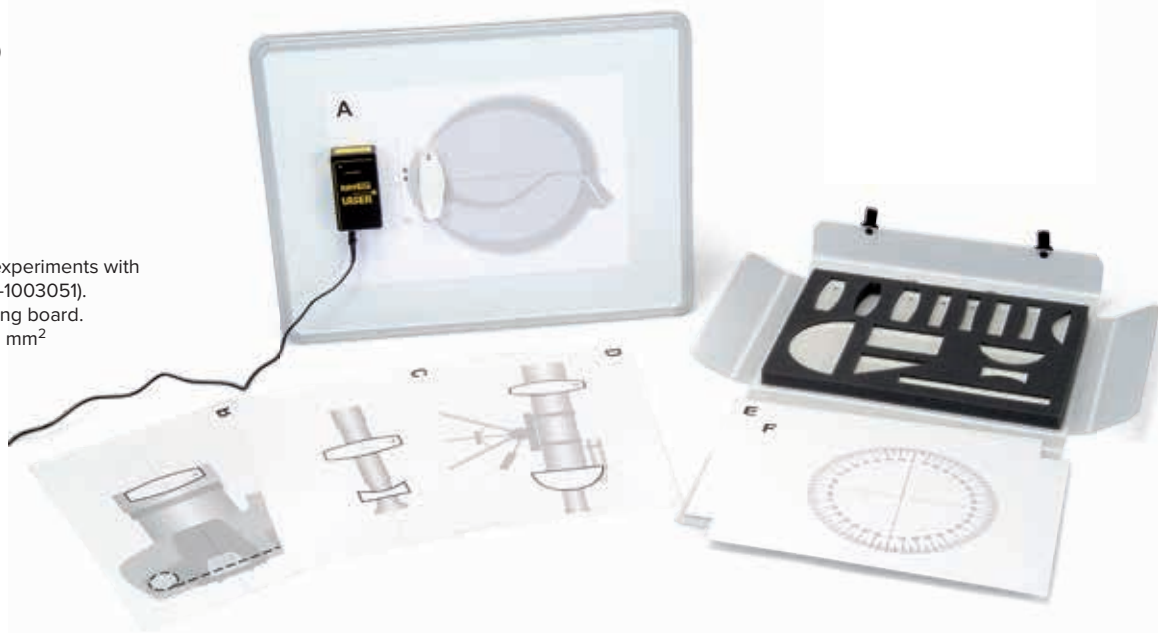

Experiment Topics:

- Law of refraction
- Law of reflection
- Total reflection
- Determining the focal length of curved mirrors and lenses
- Lens laws
- Correction of spherical aberration
- Short-sightedness and long-sightedness of the human eye and the correction of such defects
- Beam paths in cameras, microscopes and telescopes

Equipment Set Optics with Laser Ray Box

Set of optical components for use in combination with a laser ray box (P-1003052 resp. P-1003051) and related board (P-1003056). This equipment set is ideal for conducting a wide variety of experiments on ray optics. Equipped with magnetic foil, the components can be easily attached to the board and aligned. Six work templates with pre-defined positions facilitate experiment setup. The beam paths can be observed from a relatively long way away without any need for darkening the room.
Basic length: 100 mm each (in most cases)
Thickness: 15 mm each

Contents:

1 Biconcave lens	1 Convex mirror
4 Biconvex lenses	1 Flat parallel block (60x100 mm ²)
1 Plano-concave lens	1 Prism
1 Hemispherical body (45 mm)	1 Wave guide (20x200 mm ²)
1 Hemispherical body (75 mm)	6 Work sheets (410x290 mm ²)
1 Plane mirror	1 Experiment guide
1 Concave mirror	

P-1003049

Additionally required:

P-1003052 Laser Ray Box (230 V, 50/60 Hz)
or
P-1003051 Laser Ray Box (115 V, 50/60 Hz)
P-1003056 Board for Laser Ray Box

Laser Optics Supplemental Set with Laser Ray Box

Supplementary kit to the demonstration laser optic set with laser ray box, consisting of 13 optical components for more advanced experiments on geometric optics, e.g. experiments using air lens that show why optical elements cause either negative or positive refraction. All components are coated with magnetic foil.

Base length: 100 mm each (in most cases)
Thickness: 15 mm each

Contents:

1 Biconcave lens	2 Flat parallel blocks (rectangular)
1 Biconvex lens	2 Plane mirror
1 Equilateral prism	1 Biconcave "air lens"
2 Rectangular prisms	1 Biconvex "air lens"
1 Flat parallel block (square)	1 "Air prism"

P-1003050



Experiment Topics:

- Focal point of a converging lens
- Focal length
- Diverging lens
- Prism
- Parallel block

Set of Optical Components

In conjunction with the five-beam optical lamp (P-1003187), this equipment set is intended for experiments introducing students to geometric optics. The optical components are made of acrylic glass. Height: 15 mm each

Contents:

- | | |
|----------------------|------------------------|
| 1 Planar-convex lens | 1 Irregular prism |
| 2 Bi-convex lenses | 1 Plane-parallel plate |
| 1 Bi-concave lens | 1 Semicircular element |
| 1 Equilateral prism | 1 Cylindrical lens |
| 1 Rectangular prism | |
- P-1002993**

Five-Beam Optical Halogen Lamp 12 V, 55 W

Bright light source with five parallel light apertures for experiments involving ray optics to be conducted on a lab bench. In metal housing with integrated ventilation fan. Includes an adjustable reflecting mirror for setting the beam length. Thanks to a magnetic foil the lamp can also be used on a whiteboard.

Halogen lamp: 12 V, 50 W
 Connection: 4 mm safety sockets
 Slit width: 2 mm
 Slit spacing: 18 mm
 Housing dimensions: approx. 210x118x85 mm³

P-1003187

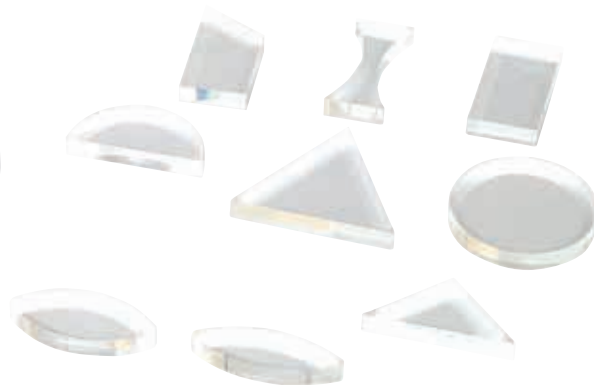

Additionally required:

- P-1000593 Transformer 12 V, 60 VA (230 V, 50/60 Hz)**
 or
P-1006780 Transformer 12 V, 60 VA (115 V, 50/60 Hz)
P-1002993 Set of Optical Components

Experiment Topics:

- Reflection and refraction of light by semicircular elements and prisms
- Snell's law
- Critical Angle



Optical Disc with Diode Laser

Set of apparatus for a comprehensive and easily understandable introduction to the basic principles of refraction and reflection of light by means of demonstration or student experiments. The laser can be easily attached via its built-in magnet and aligned on the end of the metal base. The rotating optical disc has an angular scale with 1° divisions and marked lines to position the elements. The set includes a semi-circular disc and an equilateral prism for use in optical experiments, as well as a plug-in mains-adaptor power supply and a battery compartment (batteries are not included in the apparatus as supplied).

Diode Laser: 1 beam, Class II
 Output power: <1 mW
 Wavelength: 635 nm
 Operating voltage: 3 V DC
 Battery-box: for 2x 1.5 V batteries (AA, LR6, MN1500, Mignon)
 Laser ray box: 80x25x21 mm³
 Metal base: 320x40x35 mm³

Optical disc: 250 mm diam.
 Semicircular element: 90 mm diam.
 Prism: 100 mm equilateral

Optical Disc with Diode Laser (230 V, 50/60 Hz)
P-1003058

Optical Disc with Diode Laser (115 V, 50/60 Hz)
P-1003057

Additionally recommended:
P-1003191 Semicircular Cell



Semicircular Cell

Graduated cell with 1 mm scale division, made of acrylic glass.
 Dimensions: 200 mm diam.
 Height: 20 mm
P-1003191

With a dependability that has been proven over the course of decades, the popular Kröncke optical system provides the precision necessary for student exercises and practical experiments in a wide range of experiments on ray optics and wave optics.

All optical components are mounted in diaphragms with no stem and can easily be moved up and down on an optical rider, perpendicular to the optical axis for the purpose of precise adjustment. The optical riders can be freely moved along the optical bench's U-shaped profile and secured by means of a simple clamping mechanism.



Advantages

- Rugged design
- Rapid set-up
- Extensive accessories



A. Optical Bench K

Optical bench made of black anodised aluminium profile with printed millimetre scale.

Cross-section: approx. 70x30 mm²

Art. No.	Length	Weight
A. P-1009699	2000 mm	2.4 kg
B. P-1009696	1000 mm	1.2 kg
C. P-1009926	500 mm	0.6 kg



B. Optical Lamp K

Halogen lamp in cylindrical housing attached to diaphragm screen (100x100 mm²) for mounting on optical rider K (1000862). The filament can be aligned horizontally or vertically.

Halogen lamp: 12 V, 20 W
 Terminals: 4 mm safety sockets
 Dimensions: approx. 60x100x100 mm³
 Weight: approx. 130 g

P-1000863

Additionally required:

P-1000866 Transformer 12 V, 25 VA (230 V, 50/60 Hz)

or

P-1000865 Transformer 12 V, 25 VA (115 V, 50/60 Hz)

D. Optical Rider K

Optical rider for K-model optical benches (1009699, 1009696 and 1009926). With two clamps for diaphragms from the Kröncke optical system or for plates up to 2 mm thick.

Dimensions: approx. 40x50x35 mm³

Weight: approx. 70 g

P-1000862

E. Transformer 12 V, 25 VA

Simple transformer for student exercises. Short circuit proof, with connection leads and two cascadable 4 mm safety plugs.

- Safety transformer conforming to EN 61558-2-6
- Safe isolation between power supply and output circuits

Output: 12 V AC, max. 2 A

Dimensions: approx. 110x95x65 mm³

Weight: approx. 0.64 kg

P-1000866 Transformer 12 V, 25 VA (230 V, 50/60 Hz) £43.00

P-1000865 Transformer 12 V, 25 VA (115 V, 50/60 Hz) £43.00

Halogen Lamp 12 V/20 W (not shown)

Special substitute lamp for the optical lamp K (P-1000863).

P-1003533

Micrometer Screw K

Micrometer screw with fine tip for measuring diffraction and interference lines. Holder fits the optical rider K (P-1000862).

Dimensions: approx. 80x30x60 mm³

Weight: approx. 120 g

P-1000887

Plane Mirror K

Simple plane mirror, glass.
 Dimensions: 100x100 mm²
 Weight: approx. 70 g

P-1003532

Concave Mirror K

Concave mirror on diaphragm screen 100x100 mm².

Focal length: 180 mm

Mirror diam.: 32 mm

Dimensions: 100x100 mm²

P-1009925

Iris Diaphragm K

Continuously adjustable iris on diaphragm screen 100x100 mm².

Aperture: 2 – 18 mm

Dimensions: 100x100 mm²

P-1000850



Optical Lenses K

Lenses made of high-grade optical glass. Shock-proof and crack-proof installation in optical diaphragm (100x100 mm²). With focal length specification.

Dimensions: 100x100 mm²
 Lens diameter: 32 mm



Art. No.	Designation
P-1000869	Convex Lens K, f = 50 mm
P-1010300	Convex Lens K, f = 100 mm
P-1000871	Convex Lens K, f = 150 mm
P-1009861	Convex Lens K, f = 200 mm
P-1009866	Convex Lens K, f = 300 mm
P-1009863	Convex Lens K, f = 500 mm
P-1009864	Concave Lens K, f = -100 mm
P-1009865	Concave Lens K, f = -500 mm



Fresnel Mirror K

Fresnel mirror with holder for use on K-model optical benches (P-1009699, P-1009696 or P-1009926). Two mutually inclined surface-coated mirrors are bonded to a common metal plate. A knurled screw at the rear can be used to adjust the angle between the mirrors. The wave nature of light can be demonstrated by interference following reflection at both mirrors. Holder matches the optical rider K (P-1000862).

Dimensions: 135x100x40 mm³
 Weight: approx. 123 g

P-1009927

Storage Box

Box made from smoked beech, varnished, with 20 compartments for lenses and optical elements of width 100 mm.

Dimensions: 400x130x90 mm³
 Weight: approx. 1,000 g

P-1003571

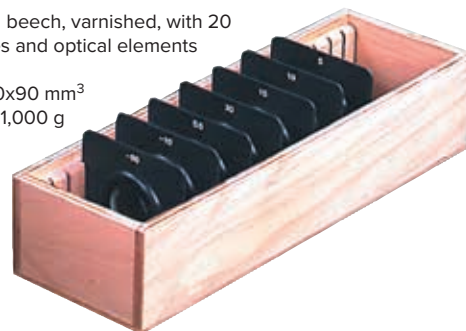

Projection Screens K (not shown)

Plastic projection screens for mounting on optical rider K (P-1000862).

Dimensions: 200x150 mm²

Projection Screen K, transparent
P-1000878

Projection Screen K, white
P-1000879

Holder K for Diode Laser

Magnetic holder for diode laser (P-1003201 or P-1003202). On diaphragm screen 100x100 mm².

P-1000868



Clamp K

Tough clamp for diaphragms, filters, diffraction objects and other objects in a slide frame (see as of page 161). On diaphragm screen 100x100 mm².

Clamping range: 0.2 – 4 mm
 Dimensions: 100x100 mm²
 Round opening: 38 mm diam.

P-1008518



Adjustable Slit K

Continuously adjustable slit on diaphragm screen (100x100 mm²). The slit width can be adjusted by means of a micrometer screw.

Slit width: 0 – 3 mm
 Slit height: 25 mm
 Dimensions: 100x100 mm²
 Weight: approx. 240 g

P-1008519



Pair of Polarisation Filters K

Two polarising filters on a diaphragm screen (100x100 mm²) for producing and analysing polarised light. In a rotating frame with a pointer and protractor scale.

Scale: 0 – 180°
 Scale division: 5°
 Dimensions: 100x100 mm²
 Filter diameter: 32 mm

P-1009929



The inexpensive NEVA optics system offers reliability and ease of use for setting up basic experiments in ray optics. All the optical components are set in a slide with a magnetic base and can easily be aligned on a sturdy optical base and moved into a beam of light.



Optical Bench N

Metal rail with millimetre scale and guide slots for accommodating optical components on a magnetic base.

Dimensions: 400x75x10 mm³

Weight: approx. 230 g

P-4003987



Parallel Light Optical Lamp N (230 V, 50/60 Hz)

Light source for parallel and divergent beams based on a high-powered white LED in a plastic housing with a magnetic base. The outlet side for parallel light has a slot for a slide and there is also a side for outputting divergent beams. Includes 5-V-DC, 1000-mA plug-in power supply.

Dimensions: 90x70x70 mm³

Weight: approx. 400 g

P-1006791



Optical Lamp N (230 V, 50/60 Hz)

High-powered white LED in a plastic housing with a magnetic base. Includes 5-V-DC, 1000-mA plug-in power supply.

Dimensions: 90x70x70 mm³

Weight: approx. 200 g

P-1009946



Object Holder N

Object holder with magnetic base to accommodate optical apertures in slides (50x50 mm²), e.g. single slit N (P-4004002) or triple/quintuple slit N (P-4004057).

P-1000845



Single Slit N

Single slit slide for mounting in N-model object holder or in the filter slot of the N-model parallel light optical lamp to use in optical experiments requiring a tight single beam.

Dimensions: 50x50 mm²

P-4004002



Triple/Quintuple Slit N

Slide with a triple and a quintuple slit arrangement for mounting in N-model object holder (P-1000845) or in the slide slot of the N-model parallel light optical lamp (P-1006791 or P-1006790) to use in optical experiments requiring multiple tight beams.

Dimensions: 50x50 mm²

P-4004057

Optical Lenses N

Lenses made of high-quality optical glass. Breakage and impact-resistant, set in a slide with magnetic base.

Dimensions: 70x70 mm²

Lens diameter: 36 mm

Art. No.	Designation
P-1000843	Convex Lens N, f = +50 mm
P-1000842	Convex Lens N, f = +100 mm
P-1000841	Convex Lens N, f = +300 mm
P-1000844	Concave Lens N, f = -100 mm



Experiment Topics:

- Demonstration of various light beams
- Reflection of a light ray by a plane mirror
- Reflection of a beam of rays by a plane mirror
- Reflection of a beam of rays by a concave / convex mirror
- Snell's law of refraction
- Refraction by a plane-parallel plate
- Refraction by a prism
- Inverting prism
- Concave and convex lenses

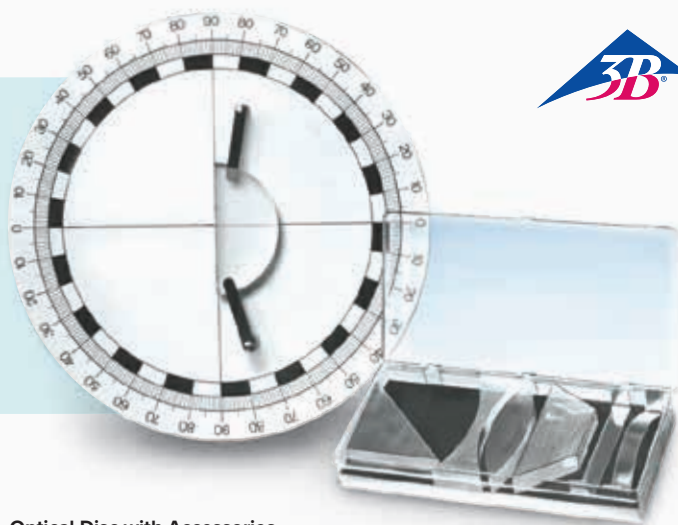

Swivel Joint with Scale

Connecting piece for articulated linking of two U-model optical benches (P-1003039 and P-1003040). Profile rails. 90° articulation angle in both directions. Natural-finish, anodised aluminium. With a mounting for optical attachments on a stem at the axis of rotation.

Clamping width for stems: 10 mm

Scale division: 5°

Dimensions: approx. 180x82x100 mm³

P-1003043



Optical Rider U

Optical rider for U-model optical benches (P-1003039 and P-1003040) for mounting optical attachments on a stem. A smooth base ensures easy movement on the optical bench.

Clamping width for stems: 10 mm

Art. No.	Sleeve height
P-1003041	75 mm
P-1003042	30 mm

Optical Disc with Accessories

This equipment set introduces the fundamentals of geometric optics. It consists of a base plate with an angular scale possessing 1° divisions, a block scale and two bore holes for mounting clamps for optical components (lenses, prisms, mirrors). An adjustable holder and tripod permit horizontal as well as vertical installation.

Delivered with a storage case, this equipment set comprises the following items:

- 1 Optical disc with a holding stem and 2 clamps, 240 mm diam.
- 1 Bi-concave lens, 80 mm
- 1 Bi-convex lens, 80 mm
- 1 Semi-circular element, 80 mm
- 1 Trapezoid element, 45° and 60°
- 1 Prism, rectangular, leg length 50 mm
- 1 Combined mirror (planar, convex, concave)

P-1003036

Additionally recommended:

- P-1003039** Optical bench U, 120 cm
- P-1003041** Optical rider U, 75 mm (3x)
- P-1003042** Optical rider U, 30 mm
- P-1003038** Experiment lamp, halogen
- P-1000855** Object holder on a stem
- P-1003024** Convex lens, $f = +150$ mm
- P-1000607** Set of slits and apertures
- P-1000593** Transformer 12 V, 60 VA (230 V, 50/60 Hz)
- or
- P-1006780** Transformer 12 V, 60 VA (115 V, 50/60 Hz)

Pair of Rail Supports

Two support feet made of natural-finish, anodised aluminium for U-model optical benches (P-1003039 and P-1003040).

Dimensions: approx. 220x20x15 mm³

P-1003044



Optical bench U

Comprising a solid aluminium profile, anodised with natural finish, robust and resistant to twisting, with mm scale along the full length. For experiments with optical attachments on a stem.

Cross-section: approx. 100x40 mm²

Art. No.	Length	Scale length	Weight
P-1003039	1200 mm	1000 mm	approx. 3.0 kg
P-1003040	600 mm	500 mm	approx. 1.5 kg

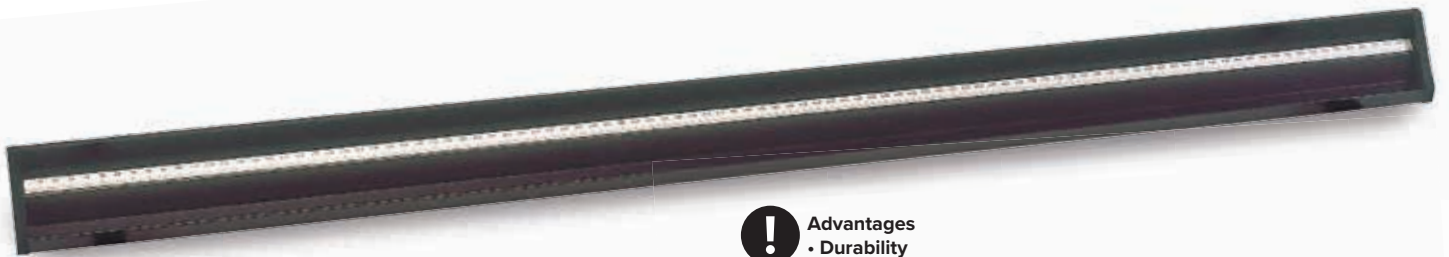

Optical Precision Bench D

Optical precision bench with a triangular profile for research and demonstration experiments requiring maximum accuracy. Made of black, anodised aluminium. Tilt-proof, slip-proof, resistant to bending and twisting, equipped with a full-length scale with cm/mm divisions. Bore holes on front end for securing connecting elements for additional rails or swivel joint (P-1002632).

Cross-section: approx. 90x60 mm³

Art. No.	Length	Weight
P-1002630	500 mm	approx. 1.75 kg
P-1002628	1000 mm	approx. 3.5 kg
P-1002629	2000 mm	approx. 7 kg



Advantages

- Durability
- Tough, three-sided profile
- Millimetre precision

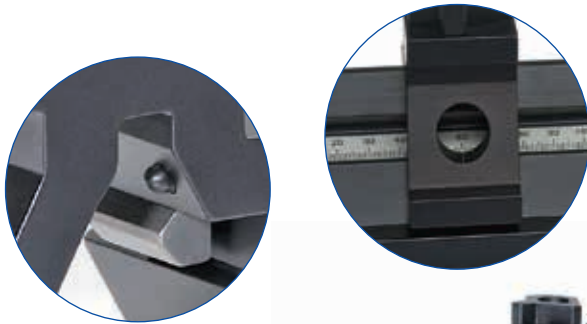

Optical Rider D

Optical rider for D-model precision optical benches (P-1002628, P-1002629 and P-1002630) for mounting optical attachments on a stem. For research and demonstration experiments requiring maximum accuracy. Made of black anodised aluminium. Thanks to a hole drilled in the middle of the base and an accompanying scale, it is possible to read off the position of the centre of the rider on the optical bench directly. The riders are preliminarily fixed to the optical bench via springy built-in plastic nipples until the grub screw is tightened. Long-term attachment is designed to protect the materials using a stainless steel pressure shoe rather than the point of a screw. The stems of the optical equipment placed on the bench are also designed to protect the materials in that they are clamped using a stainless bracket.

Clamping width for rods: 10 – 14 mm

Art. No.	Sleeve height	Base width
P-1012400	60 mm	50 mm
P-1002635	90 mm	50 mm
P-1002637	120 mm	50 mm
P-1002639	60 mm	36 mm
P-1012401	90 mm	36 mm

Sliding Rider D

Optical rider with a mounting for optical attachments on a stem, adjustable vertically with respect to the optical axis. Sliding rider with micrometer screw for position adjustment.

Sliding range: ±12.5 mm
 Sleeve height: 90 mm
 Base width: 50 mm
 Clamping width for rods: 10 – 14 mm

P-1002644

Tilting Rider D

Optical rider for tilting optical elements out of the optical axis.

Sleeve height: 90 mm
 Base width: 50 mm
 Clamping width for rods: 10 – 14 mm
 Tilting range: 90°

P-1012467



Support for Optical Bench D

One rail support and a single-point support with screws for adjusting optical bench. Made of black, anodised aluminium.

Length of rail support: 270 mm

P-1012399



Swivel Joint for Optical Bench D

For experiments where light is deflected and where the highest precision requirements prevail. Black anodized aluminum with adjustable protractor scale $\pm 180^\circ$ in 1° divisions. Sleeve for holding optical elements shaft mounted.

Protractor scale: $\pm 90^\circ$

Sleeve height: 60 mm

Clamping width

for rods: 10 – 14 mm

P-1002632

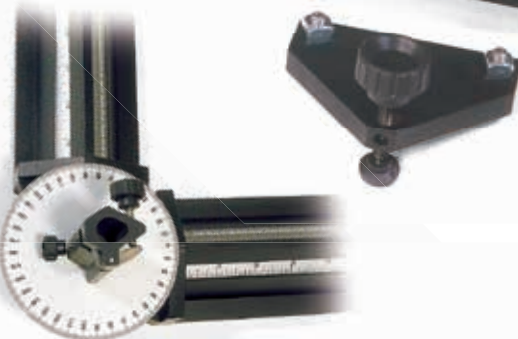

Optical Base D

Optical base used for mounting a U-shaped transformer core (P-1000979) with coils and pole terminals for conducting experiments on the Faraday effect using precision optical bench D (P-1002628).

Dimensions: approx. 148x85x60 mm³

P-1009733

Extension Arm D

Extension Arm to clamp on an optical rider D, for positioning optical elements out of the optical axis.

Extension arm: 100 mm

Clamping width

for rods: 10 – 14 mm

P-1002646

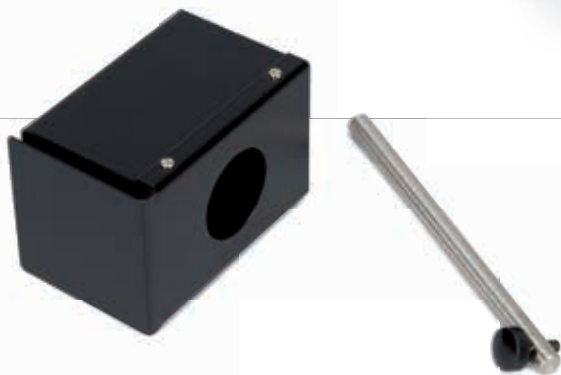

Experimental Lamp, Halogen

Light source with low-divergence beam for optical experiments. Black-painted metal housing on a stem, with fixture for vertical or horizontal set-up.

Halogen lamp: 12 V, 50 W

Connection: via 4 mm safety sockets

Light aperture: 40 mm diam.

Shaft diameter: 10 mm

Dimensions: approx. 80x80x105 mm³

P-1003038

Additionally required:

P-1000593 Transformer 12 V, 60 VA (230 V, 50/60 Hz)

or

P-1006780 Transformer 12 V, 60 VA (115 V, 50/60 Hz)

Spare Halogen Lamp, 12 V, 50 W (not shown)

Spare halogen lamp for Experimental lamp P-1003038.

P-1002837



Optical LED Lamp

Ultra-bright light source for experiments on optical bench and for projection.

It consists of a metal housing with a condenser, a movable element for axial light adjustment and a holding stem with a screw mounting.

Including plug-in power supply.

LED: 18 V, 10 W

Plug-in power supply: 100 – 240 V AC, 50/60 Hz

Condenser focal length: 100 mm

Condenser diameter: 80 mm

Shaft: 125 mm x 10 mm \varnothing

Dimensions: approx. 240x115x220 mm³

Weight: approx. 1.5 kg

P-1020630



Laser Diode, Red

Red light source giving a beam with minimal divergence, housed in a compact and sturdy aluminium body. It is based on a 650 nm class II industrial laser module with a glass collimating lens. Fitted with a 10 cm stainless steel rod. A plug-in mains-adaptor power supply is included.

Laser protection class: II
 Output power: 0.9 – 1 mW at 20° C
 Wavelength: 650 nm ± 5 nm
 Spot size at 5 m distance: <8 mm diam.
 Divergence: <1 mrad
 Plug-in power supply: Primary: 100 – 240 V, 50/60 Hz
 Secondary: 6 V DC, 300 mA

P-1003201

Laser Module, Green

High performance 532 nm green laser (doubled NdYag). The laser (safety classification II) produces green light ideally suitable for optical demonstrations, as the wavelength is in the range where the human eye has maximum sensitivity. The visibility is as good as that for red laser light from a 5 mW source. Fitted with a 10 cm stainless steel stem. The apparatus supplied includes a plug-in mains-adaptor power supply.

Laser protection class: II
 Output power: 0.4 – 1 mW at 20° C
 Wavelength: 532 nm ± 0.1 nm
 Spot size at 5 m distance: < 9 mm diam.
 Divergence: < 2 mrad
 Plug-in power supply: Primary: 100 – 240 V, 47 – 63 Hz
 Secondary: 3.3 V DC, 1.5 A

P-1003202



Achromatic Objective – 10x/0.25

Microscope objective for diverging beam in conjunction with He-Ne laser P-1003165.

P-1005408



Objective for Beam Divergence

Microscope objective 4x mounted on an adapter for diverging the beam in conjunction with the red laser diode (P-1003201) or the green laser module (P-1003202).

P-1000675



E14 Lamp Socket on Stem

E14 lamp socket on stem, with mains connection cable and Euro-plug conforming to CEE 7/16.

Shaft: 113 mm x 10 mm diam.
 Weight: approx. 135 g

P-1000853

He-Ne Laser

Monochromatic, coherent light source for optical experiments, e.g. on diffraction, interference, and hologram reconstitution. Anodised metal housing with key switch, neutral filter for attenuating beam, 2 stand rods and power supply unit. To widen the beam, microscope objectives (e.g. P-1005408) can be screwed to the beam aperture.

Laser protection class: II
 Output power: <0.2 mW (with neutral grey filter)
 <1 mW (without neutral grey filter)
 Wavelength: 633 nm
 Beam diameter: 0.48 mm
 Radiation divergence: 1.7 mrad
 Mode: TEM₀₀
 Polarisation: Random
 Service life: > 12000 hours
 Plug-in power supply: 12 V DC, 1 A
 Dimensions: approx. 230x55x90 mm³
 Weight: approx. 0.8 kg

Contents:

- 1 Helium-Neon Laser
- 2 Keys
- 1 Long stand rod
- 1 Short stand rod, 6-edges
- 1 Transformer 12 V

P-1003165

E27 Lamp Socket on Stem

E14 lamp socket on stem, with mains connection cable and earthed plug conforming to CEE 7/4.

Shaft: 113 mm x 10 mm diam.
 Weight: approx. 240 g

P-1000854 £38.00



Lenses on Stem

Lenses in black frame on stem. With a lens protection ring for preventing damage to the lens.

Holder: 130 mm diam.

Shaft: 10 mm diam.

Note:

All the components on stems illustrated on the following pages are supplied without an optical rider.

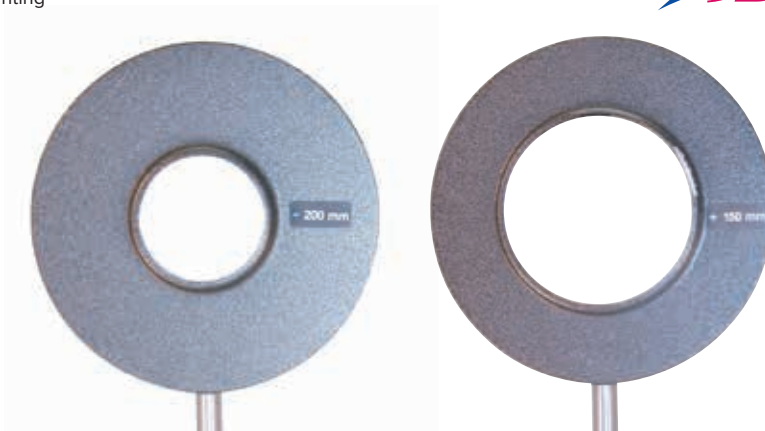

Art. No.	Designation	Focal length	Diaphragm diameter
P-1003022	Convex lens on stem	+50 mm	50 mm
P-1003023	Convex lens on stem	+100 mm	50 mm
P-1003024	Convex lens on stem	+150 mm	50 mm
P-1003025	Convex lens on stem	+200 mm	50 mm
P-1003026	Convex lens on stem	+300 mm	50 mm
P-1003029	Convex lens on stem	+150 mm	75 mm
P-1003027	Concave lens on stem	-100 mm	50 mm
P-1003028	Concave lens on stem	-200 mm	50 mm



Mirrors on Stem

Mirrors in black frame on stem. With protective ring for prevent damage to mirror.

Holder 130 mm diam.

Diaphragm: 50 mm diam.

Shaft: 10 mm diam.

Art. No.	Designation	Focal length
P-1003031	Concave mirror, on stem	+75 mm
P-1003032	Convex mirror, on stem	-75 mm
P-1003033	Plane mirror, on stem	-



Total Reflection Apparatus on Stem

Acrylic rod with bend in black metal frame on stem. Parallel light shone through the rod undergoes total internal reflection and is guided around the bent end.

Metall holder: 130 mm diam.

Shaft: 10 mm diam.

P-1000857

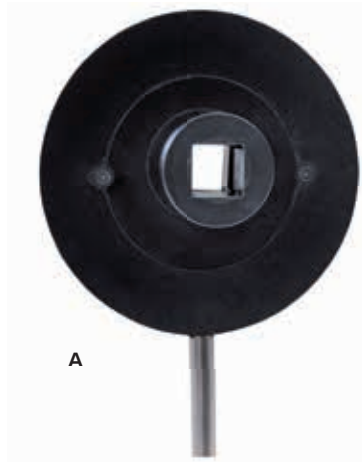

A



B

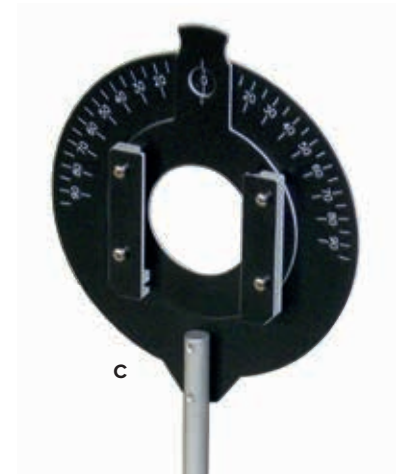

C



D

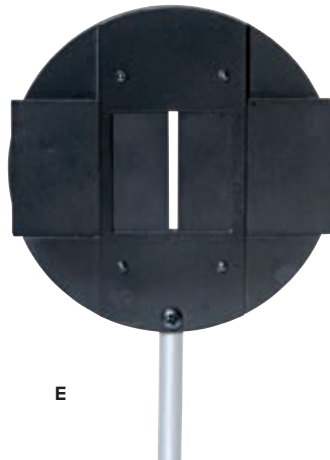

E



F

A. Holder on Stem for Direct-Vision Prism

Holder with rotating mounting for direct-vision prism (P-1002862). In black metal frame on stem.

Holder: 130 mm diam.
Shaft: 10 mm diam.

P-1012863

B. Component Holder on Stem

Holder on steel rod for supporting an optical component of circular shape. The component is held in place by a metal ring.

Aperture: 36 mm diam.
Components: 7 mm x 42 mm diam. max.
Height of optical axis: 150 mm
Mounting: 100 mm diam.
Stem: 10 mm diam.

P-1003203

C. Rotating Object Holder on Stem

Object holder in black metal frame on stem. With rotating, plug-in frame for diaphragms, filters, diffraction gratings and other objects in slide frame (see as of page 161) with protractor scale.

Holder: 130 mm diam.
Plug-in frame: 50x50 mm
Angular scale: $\pm 90^\circ$
Divisions: 5°
Shaft: 10 mm diam.

P-1003016

D. Polarisation Filter on Stem

Precision glass polarisation filter, which is in a mounting on a steel rod and can be rotated on a ball-bearing. With angular scale marked in 1° intervals.

Aperture: 38 mm diam.
Extinction coefficient: $>99.9\%$ at $\lambda = 450 - 750$ nm
Height of optical axis: 150 mm
Mounting: 100 mm diam.
Stem: 10 mm diam.

P-1008668

E. Object Holder on Stem

Object holder in black metal frame on stem. With plug-in frame for diaphragms, filters, diffraction gratings and other objects in slide frame (see as of page 161). Includes panels to partially cover the inserted objects.

Metal frame: 130 mm diam.
Plug-in socket: 50×50 mm²
Shaft diameter: 10 mm

P-1000855

F. Adjustable Slit on Stem

Slit with symmetric aperture, in black metal frame on stem. With micrometer screw.

Holder: 130 mm diam.
Slit width: 0 – 3 mm
Slit height: 25 mm
Shaft: 10 mm diam.

P-1000856

Prism Table on Stem

Round prism table with a height-adjustable clamp, e.g. for fixing prisms. On stem for mounting on optical rider. Prism not included.

Table: 60 mm diam.

Shaft: 10 mm diam.

P-1003019



Quarter-Wavelength Filter on Stem

Retardation plate ($\lambda/4$ platelet) made of plastic foil, rotatable on a ball-bearing in a holder on a stem. With an angle scale possessing 1° increments.

Aperture: 38 mm \varnothing

Retardation: $\lambda/4$ at 560 nm

Height of the optical axis: 150 mm

Holder: 100 mm \varnothing

Stem: 10 mm \varnothing

P-1021353



Projection Screen

Translucent screen, on stem, for all projection purposes on optical bench.

Dimensions: 250x250 mm²

Shaft: 10 mm diam.

P-1000608



Holder on Stem for Lenses without Frame

Holder with a clamp for mounting frameless lenses. In black metal frame on stem.

Holder: 130 mm diam.

Aperture: 40 mm diam.

Shaft: 10 mm diam.

P-1003164

Iris on Stem

Iris diaphragm in black frame, shaft-mounted. Continuously adjustable diaphragm diameter.

Holder: 130 mm diam.

Iris diameter: 3 – 29 mm

Shaft: 10 mm diam.

P-1003017

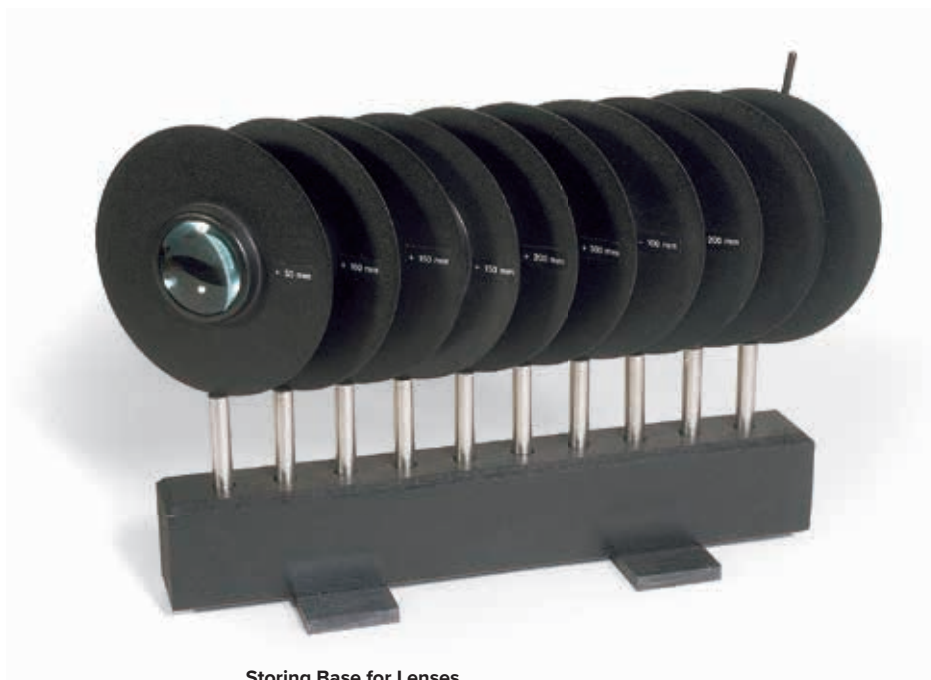

Storing Base for Lenses

Wooden strip with ten bore holes for storing instruments with 10 mm-shaft. Lenses not included.

P-1003034

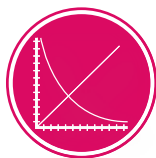

UE4030350

PDF online

Glass Inset for Newton's Rings Experiments

Optical component for demonstrating and investigating Newton's interference rings. Composed of flat and curved glass pane on a stem. Includes three adjustment screws for centring the interference module.

Height of optical beam: 150 mm
 Usable diameter: 38 mm
 Thickness of glass pane: 3 mm
 Radius of curvature: 50 m
 Diameter of setting: 100 mm
 Diameter of stem: 10 mm

P-1008669



Fresnel Mirror on Stem

This device is used to demonstrate the wave nature of light by observing interference caused by reflection at two mirrors and can be used to calculate the wavelength of light. It consists of two mutually inclined, front-coated mirrors made of black acrylic glass and fitted in black, anodised aluminium holders with firmly mounted mirror protection elements on a tripod made of high-grade steel. The angle of inclination can be finely adjusted from the rear.

Total mirror area: 30x95 mm²
 Adjustment range: -0.3° – +0.7°
 Shaft: 10 mm diam.

P-1002649

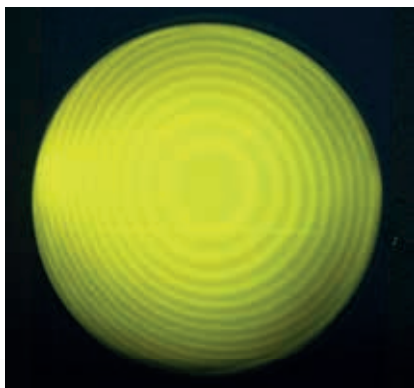

Newton's rings in yellow light

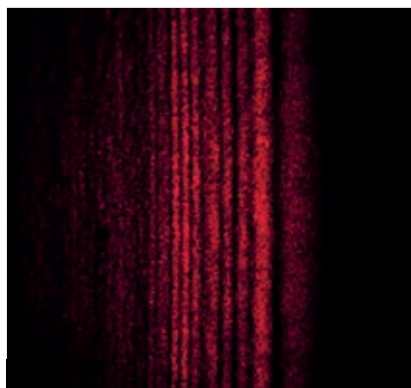

Interference pattern on the observation screen

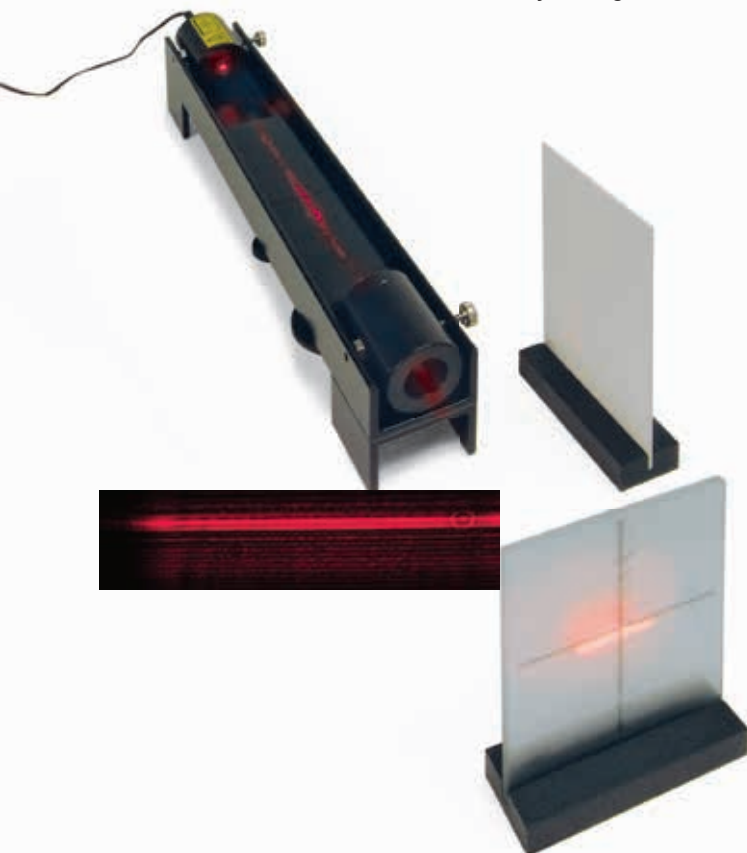

Fresnel Mirror Experiment Set

Complete equipment set for demonstrating the wave nature of light by observing the interference of laser light. This is caused by the reflection of a laser at two black planar glass mirrors which are offset by a small angle of a few degrees. The laser, mirrors and the optical projector are all mounted on a metal base. One mirror is fixed and the other is adjustable to change the angle of inclination. A projection screen, a ground glass screen with scaled crosshairs and a battery box are also included.

Diode Laser: class II
 Output power: < 1 mW
 Wavelength: 635 nm
 Operating voltage: 3 V DC
 Battery-box: for 2x 1.5 V batteries (AA, LR6, MN1500, Mignon) (batteries not included)

Dimensions:
 Metal base: 400x75x85 mm³
 Screens: 150x90x30 mm³

P-1003059

Additionally recommended:

P-1008659 Plug-In Power Supply 3 V DC

Plug-In Power Supply 3 V DC (not shown)

Plug-in mains adaptor to provide electrical power supply for the Fresnel mirror experiment set (P-1003059).

Mains voltage: 100 – 240 V, 50/60 Hz

P-1008659

Geometrical Objects

For fitting on an object holder on a stem (P-1000855), in a rotatable object holder on a stem (P-1003016) or in a clamping holder K (P-1008518).

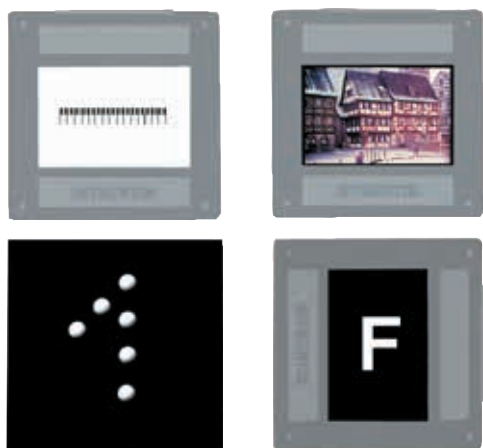

Set of 4 Image Objects

Set of four image objects in a slide frame.

Dimensions: 50x50 mm²

Contents:

1 Scale, 15 mm with scale divisions of 0.1 mm

1 Photograph

1 F diaphragm

1 Number 1 diaphragm

P-1000886



Set of 5 Slit and Hole Diaphragms

Five slit and hole diaphragms in a slide frame.

Dimensions: 50x50 mm²

Contents:

1 Slit, slit width 1 mm

1 Threefold slit, slit width 1 mm, slit spacing 5 mm

1 Fivefold slit, slit width 1 mm, slit spacing 5 mm

1 Apertured diaphragm, diam. 8 mm

1 F diaphragm

P-1000607

Set of 5 Hole Diaphragms

Five hole diaphragms of different diameters in a slide frame.

Hole diameter: 1/ 3/ 6/ 10/ 15 mm

Dimensions: 50x50 mm²

P-1000848

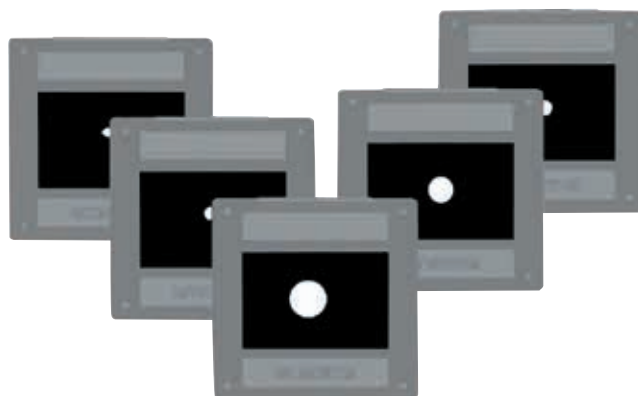

Geometrical Objects

Suitable for mounting in the optical component holder (P-1003203).

Geometrical Objects on Glass Plate

High quality, chrome-plated glass plate with four scales and three geometrical objects for quantitative experiments on geometric optics. The glass plate is highly resistant against ageing and contamination.

Diameter: 40 mm

Thickness: 1.5 mm

Length of scale: 10 mm

Graduation: 10 mm, 2 mm, 1 mm, 0.5 mm

Geometrical objects:
 Arrow 30 mm long
 Square 5 mm side length
 Disc 5 mm diam.

P-1014622

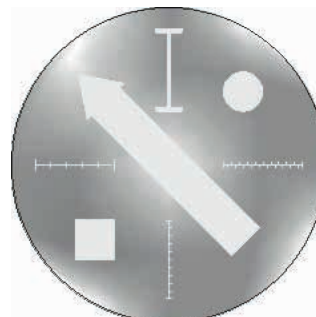

➤ Diffraction Objects

For fitting on an object holder on a stem (P-1000855), in a rotatable object holder on a stem (P-1003016) or in a clamping holder K (P-1008518).



Transmission Grating

Transmission grating for spectroscopic examinations and for experiments on diffraction and interference. Suitable to resolve the Na-D lines. Mounted on glass carrier.

Dimensions: 38x50 mm²

Art. No.	Description	Lines/mm
P-1003080	Transmission Grating	300
P-1003079	Transmission Grating	600

Diaphragm with a Single Slit and Rib

Photographic diffraction object in a slide frame.

Slit and rib width: 0.5 mm each
Dimensions: 50x50 mm²

P-1000602



Diaphragm with 3 Single Slits and 1 Double Slit

Photographic diffraction object in a slide frame.

Single slit widths: 0.075 / 0.15 / 0.4 mm
Double slit width: 0.1
Double slit spacing: 0.5 mm
Dimensions: 50x50 mm²

P-1000885



Set of 5 Single Slits

Five single slits of different widths in a slide frame.

Slit widths: 0.1/ 0.2/ 0.4/ 0.8/ 1.6 mm

Dimensions: 50x50 mm²

P-1000846



Hologram

Transmission hologram in slide holder.

Dimensions: 50x50 mm²

P-1003177



Copy of a Rowland Grating

This copy of a Rowland grating is supplied on a collodion foil between two glass plates in a metal frame for the purpose of projecting diffraction spectra, measuring wavelengths and observing spectra with spectrum lamps.

Number of lines: 600 Lines/mm

Dimensions: 50x50 mm²

P-1002917

Demonstration Gratings

Three diffraction gratings on a frame for demonstrating the relationship between line spacing and diffraction angle.

Number of lines: 100/ 300/ 600 lines/mm.

Dimensions: 90x30 mm²

P-1003082



Diaphragms with Circular Holes and Discs

Photographic diffraction objects in a slide frame.
Dimensions: 50x50 mm²



Art. No.	Description	Diameter
P-1000603	Diaphragm with 3 Circular Hole and Disc Pairs	1.0/1.5/2.0 mm
P-1000889	Diaphragm with 9 Circular Discs	0.1 – 1.8 mm
P-1000891	Diaphragm with 9 Circular Holes	0.1 – 1.8 mm

Diaphragms with Double and Multiple Slits

Photographic diffraction objects in a slide frame.
Dimensions: 50x50 mm²

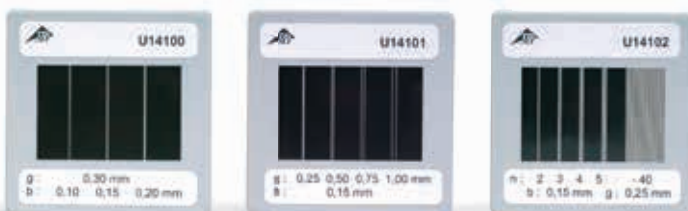

Art. No.	Description	Slit spacing	Slit width	No. of slits
P-1000596	Diaphragm with 3 Double Slits of Different Widths	0.3 mm	0.10/0.15/0.20 mm	2
P-1000597	Diaphragm with 4 Double Slits of Different Spacings	0.25/0.50/0.75/ 1.00 mm	0.15 mm	2
P-1000598	Diaphragm with 4 Multiple Slits and Gratings	0.25 mm	0.15 mm	2/3/4/5/40

Diaphragms with Gratings

Photographic diffraction objects in a slide frame.
Dimensions: 50x50 mm²



Art. No.	Description	Grating constant	Slit width	No. of lines
P-1000599	Diaphragm with 3 Ruled Gratings	0.5/0.25/0.125 mm	0.25/0.125/ 0.063 mm	2/4/8 Lines/mm
P-1000600	Ruled Gratings	0.125 mm	0.063 mm	8 Lines/mm
P-1000601	Diaphragm with 2 Cross Gratings	0.25 mm	0.125 mm	4 Lines/mm

Set of 4 Gratings
Four line gratings mounted in slide frame with protective glass plates.
For student and demonstration experiments.
Number of lines: 80/ 100/ 300/ 600 Lines/mm
Dimensions: 50x50 mm²
P-1003081



Gratings

Line gratings in slide frames. For students and demonstration experiments.
Dimensions: 50x50 mm²

Art. No.	Description	Lines/mm
P-1003178	Grating	140
P-1003179	Grating	530
P-1003180	Grating	600
P-1003181	Grating	1000

> Diffraction Objects on Glass Plates

Suitable for mounting in the optical component holder (P-1003203). Chromium-coated glass plates with diffraction objects of high precision and regularity applied by microlithography. The glass supports are highly resistant against ageing and contamination.

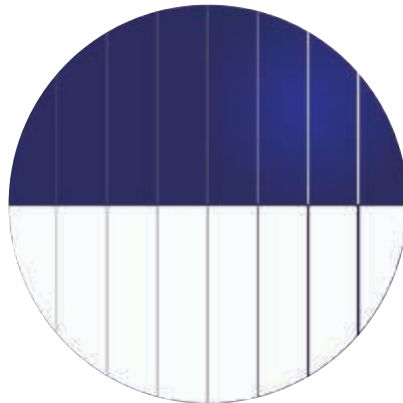

Diffraction Apertures on Glass Plate

Glass plates with 12 different single and double diffraction apertures for quantitative diffraction experiments.

Diameter of support: 40 mm

Aperture irregularities: <1 μm

Single apertures:

Diameters: 20, 30, 50, 100, 200 and 500 μm

Double apertures:

Separations: 100, 200 and 400 μm
Diameter: 50 μm

Rectangular apertures:

Dimensions: 70x70 μm^2 ,
200x200 μm^2 and
70x200 μm^2

P-1008664

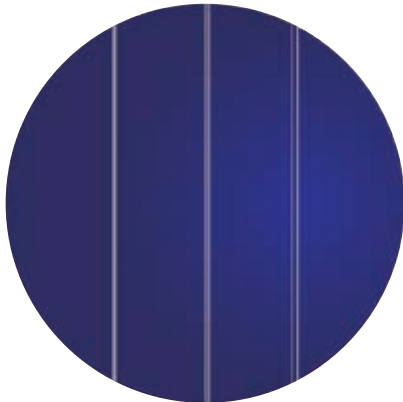

Slits and Bars on Glass Plate

Glass plates with 7 sets of slits and bars of different widths for quantitative diffraction experiments.

Diameter of support: 40 mm

Irregularities: <1 μm

Slit widths: 30, 40, 60, 80, 100, 150 and 200 μm

Bar widths: 30, 40, 60, 80, 100, 150 and 200 μm

P-1008665

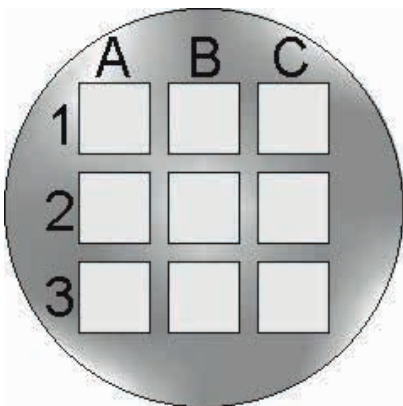

Microstructures on Glass Plate

Glass plate with nine different microstructures consisting of discs, rectangles and squares for quantitative diffraction experiments.

Diameter: 40 mm

Thickness: 1.5 mm

Disc diameters: 30 μm , 50 μm , 100 μm

Rectangles: 10x50 μm^2 , 20x100 μm^2 ,
30x150 μm^2

Squares: 40x40 μm^2 , 70x70 μm^2 ,
120x120 μm^2

P-1014620

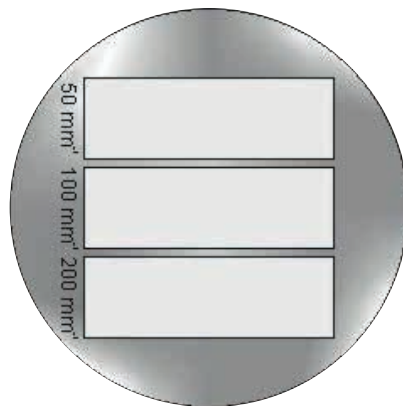

Diffraction Gratings on Glass Plate

Glass plate with three diffraction gratings of different number of lines for quantitative diffraction experiments.

Diameter: 40 mm

Thickness: 1.5 mm

Surface: 25x7.5 mm each

Number of lines: 50, 100, 200 / mm

Gratings pitch: 20, 10, 5 μm

Precision: <1 μm

P-1014621

Double Slits on Glass Plate

Glass plates with three double slits of different separations for quantitative diffraction experiments.

Diameter of support: 40 mm

Irregularities: <1 μm

Slit width: 70 μm

Separations: 200, 300 and 500 μm

P-1003204

Multiple Slits on Glass Plate

Glass plates with four different numbers of multiple slits for quantitative diffraction experiments.

Diameter of support: 40 mm

Irregularities: <1 μm

Slit width: 40 μm

Slit separation: 100 μm

Number of slits: 3, 4, 6 and 14

P-1008666

> Colour Filters

For fitting on an object holder on a stem (P-1000855), in a rotatable object holder on a stem (P-1003016) or in a clamping holder K (P-1008518).



Set of 3 Colour Filters, Primary Colours

Set of 3 colour filters, primary colours, in slide frames.

Colours: Red, green, blue

Dimensions: 50x50 mm²

P-1003185

Set of 3 Colour Filters, Secondary Colours

Set of 3 colour filters, secondary colours, in slide frames.

Colours: Cyan, yellow, magenta

Dimensions: 50x50 mm²

P-1003186

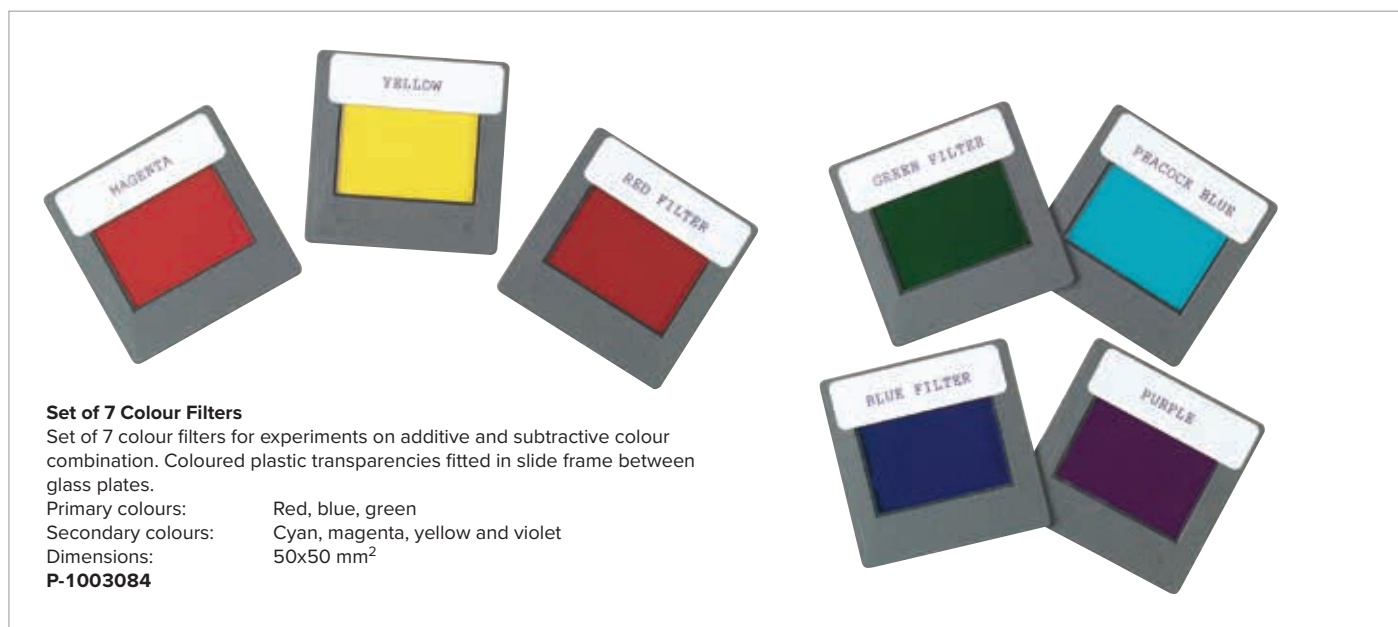

Set of 7 Colour Filters

Set of 7 colour filters for experiments on additive and subtractive colour combination. Coloured plastic transparencies fitted in slide frame between glass plates.

Primary colours: Red, blue, green

Secondary colours: Cyan, magenta, yellow and violet

Dimensions: 50x50 mm²

P-1003084

> Interference Filters

Suitable for mounting in the optical component holder (P-1003203).



Interference Filters

Narrow frequency-range optical filters for filtering out light of a specific wavelength from a spectrum featuring multiple wavelengths or for making a nearly mono-chromatic light source from a continuous spectrum.

Diameter: 40 mm

Thickness: 3 mm

Precision: 3 nm

Band width

(full width half maximum): 10 nm

Transmission: > 60 %

Parasitical transmission: < 1 %

Art. No.	Wavelength	Filtered spectral lines
P-1008671	436 nm	Blue mercury line
P-1008670	546 nm	Green mercury line
P-1008672	578 nm	Yellow mercury doublet

Additionally required:

P-1003203 Component Holder



60° Prisms

Equilateral prisms for use on the prism table on shaft (P-1003019).

	P-1002858	P-1002859
Material	Crown glass	Crown glass
Refractive index	1.515	1.515
Side length	27 mm	45 mm
Height	50 mm	50 mm

	P-1002864	P-1002865
Material	Crown glass	Flint glass
Refractive index	1.515	1.608
Average dispersion	0.008	0.017
Side length	30 mm	30 mm
Height	30 mm	30 mm

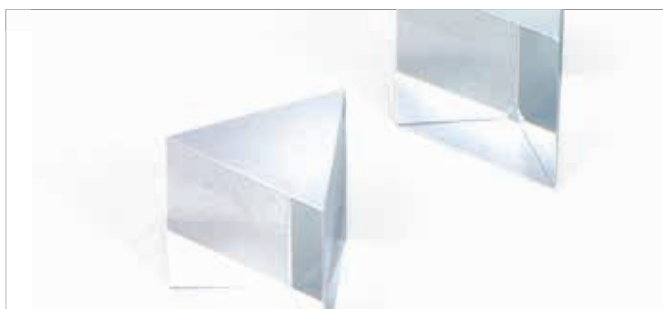

90° Prisms

Rectangular prisms for use on the prism table on stem (P-1003019).

	P-1002860	P-1002861
Material	Crown glass	Crown glass
Refractive index	1.515	1.515
Side length	30 mm	45 mm
Height	50 mm	50 mm



Set of 3 Prisms

Set of prisms for demonstrating the design of an achromatic prism and a direct vision prism. Consists of a thin flint glass prism, as well as thin and thick crown glass equilateral prisms. The two thin prisms deflect a light beam equally strongly but with different dispersions. Moving them closer together in the light path results in a direct vision prism which decomposes light into its spectral components without deflecting it. The thick crown glass prism has the same dispersion as the flint glass prism, but deflects the light beam twice the distance. This permits configuration of an achromatic prism which deflects light without splitting it into a spectrum.

P-1002863

Material	Flint glass	Crown glass	Crown glass
Refractive index	1.608	1.515	1.515
Average dispersion	0.017	0.008	0.008
Base	15 mm	30 mm	18 mm
Side length	40 mm	40 mm	40 mm
Height	40 mm	40 mm	40 mm

Hollow Prism, Equal-Sided

Equal-sided hollow prism made of optical glass to study diffraction and dispersion of light in liquids. With Teflon stopper on the filling hole.

Length of base: 60 mm_{inside}
 Height: 60 mm_{inside}
 Volume: 89 ml

P-1014618

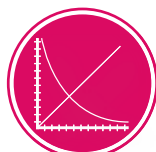

UE4030300
PDF online

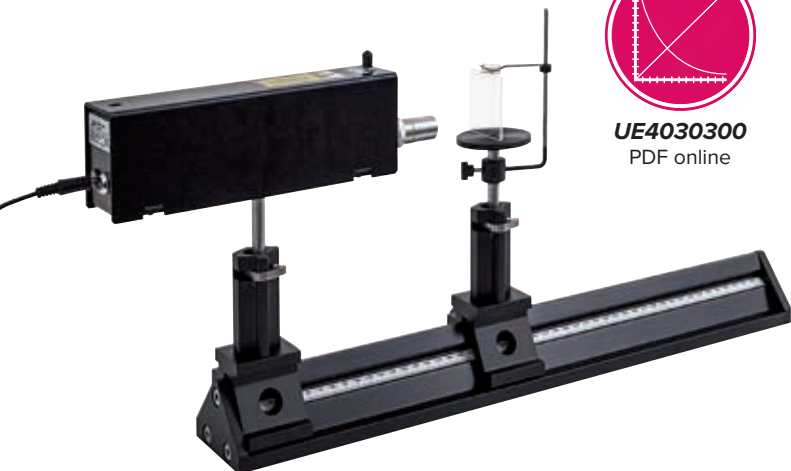

Generating interference between two beams using a Fresnel biprism



Fresnel Biprism

Fresnel biprism for observing interference by creating two virtual sources of light by refracting the light from a single coherent source.

Dimensions: 50x50x2 mm³
Prism angle: approx. 179°
Refractive index: 1.5231

P-1008652

Equipment for Fresnel biprism:

- P-1008652** Fresnel Biprism
- P-1003019** Prism Table on Stem
- P-1003165** He-Ne Laser
- P-1005408** Achromatic Objective 10x / 0.25
- P-1003025** Convex Lens on Stem f =+200 mm
- P-1002635** Optical Rider D, 90/50
- P-1002630** Optical Precision Bench D, 50 cm
- P-1000608** Projection Screen
- P-1002834** Barrel Foot, 1000 g
- P-1002603** Pocket Measuring Tape, 2 m

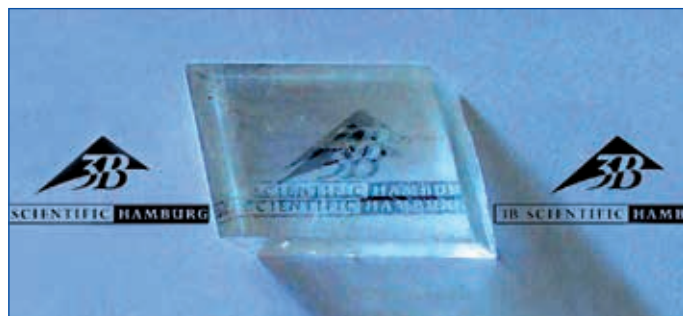

Doubly Refracting Crystal

Calcite crystal showing the birefringence in crystals.

P-5006663



Inverting Spectacles

Spectacles with two fully rotatable inverting prisms in a shielded spectacle frame. The inverting prisms reverse incoming light rays, turning the world upside down, so to speak, and making it unexpectedly difficult for the wearer to perform even the simplest of daily tasks such as reaching for objects, drawing, moving about in a room etc.

P-1000895

Amici Direct Vision Prism

A combined prism for splitting light beams into a spectrum without deflecting them. Comprises an alternating combination of two crown glass prisms and one flint glass prism; blackened on the outside.

Dispersion angle: 4.2°
Dimensions: approx. 105x20x20 mm³

P-1002862

Additionally recommended:
P-1012863 Holder for Direct-Vision Prism on Stem





Advantages

- **Plug & play: no software installation or drivers required**
- **Measurement and evaluation in real-time**
- **Simple and practical software with built-in wizards and powerful evaluation function**
- **Spectra of high quality and signal stability**
- **Low noise**
- **High resolution**
- **Suitable for measuring very slight fluctuations in intensity with very high precision**
- **Measurement of second-order diffraction without saturation of the first order**

CCD HD Sensor

Optical sensor for investigating distribution of light intensity. Particularly well suited for the investigation of light diffraction at single slits, multiple slits or diffraction gratings. User-friendly measurement and evaluation software enable simultaneous recording and analysis in real-time. The built-in software for Windows 2000/XP/Vista/7/8 32- and 64-bit versions starts running as soon as the sensor is connected to the computer via a USB cable. Includes attenuating filter, stand rod and plug-in power supply.

Software:

Data acquisition possible in two modes:
 Intensity as a function of location, e.g. for diffraction and interference.
 Intensity in a region as a function of time.
 Pointer mode, model calculation mode, spreadsheet and report modes are all available for the purposes of evaluation.

Sensor:	Toshiba 3648 pixel SWB
Resolution:	16 bits
Integration time:	0.1 ms to 6.5 s
Filter attachment:	Clix (magnetic ring)
Sensitive surface of sensor:	8 μm x 30 mm
Interface:	USB 2.0

P-1018820

Experiment Topics:

- Measurement and calculations for models of diffraction at a single slit, multiple slit and diffraction gratings.
- Interference
- Fluctuations in intensity

Additionally recommended:

- P-1003201 Laser Diode, Red**
- P-1003203 Component Holder**
- P-1008664 Diffraction Apertures on Glass Plate**
- P-1008665 Slits and Bars on Glass Plate**
- P-1003204 Double Slits on Glass Plate**
- P-1008666 Multiple Slits on Glass Plate**
- P-1002628 Optical Bench D**
- P-1002635 Optical Rider D 90/50 (3x)**

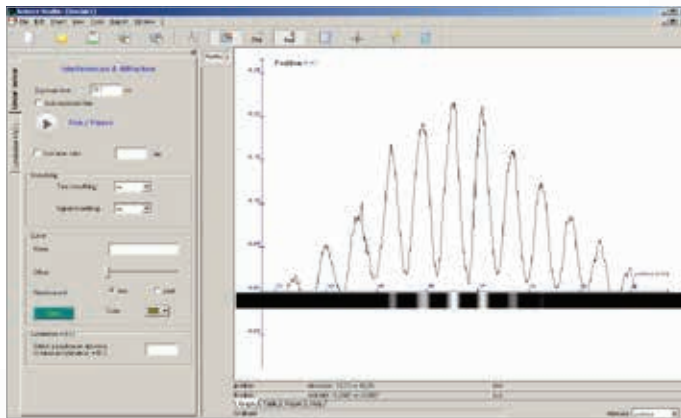

Diffraction at a single slit



Experiment Topics:

- Refraction and interference at the surfaces of a glass block, apertured diaphragm, square diaphragm, grating with slits, cross grating
- Michelson interferometer
- Investigation of linearly polarised light
- Absorption of light
- Reconstruction of a hologram

Equipment Set for Wave Optics with Laser

Equipment set for demonstrating fundamental phenomena in wave optics by means of practical experiments. The light source is provided by a partially polarised diode laser with adjustable mount. Power is supplied from a plug-in power supply (included) or from batteries. The components are magnetic and can be placed horizontally or vertically on the included metal board, according to the set-up required for the various experiments. All components are stored in a case with shaped foam inlay.

Diode laser:	max. 1 mW, laser safety class II
Wavelength:	635 nm
Plug-in power supply:	primary 100 V AC – 240 V AC secondary 3 V DC, 300 mA
Battery holder:	for 2x 1.5 V AA batteries (batteries not included)

Contents:

- 1 Diode laser with adjustable mounting
- 1 Plug-in power supply
- 1 Battery holder (without batteries)
- 2 Mirrors with adjustable mounting
- 1 Half-silvered mirror
- 1 Screen, white
- 1 Screen, frosted glass
- 1 Convex lens
- 1 Polarisation filter
- 1 Holder for lens and filter
- 3 Colour filters in slide frames (red, green, blue)
- 2 Apertured diaphragms in slide frames
- 2 Square diaphragms in slide frames
- 3 Gratings with slits in slide frames
- 1 Cross grating in slide frame
- 1 Glass plate in slide frame
- 1 Holder for slide frames
- 1 Hologram
- 1 Metal board (60x45 cm²) with removable strut
- 4 Rubber feet for metal board
- 1 Storage case
- 1 Experiment guide

P-1003053





Newton's Colour Disc, with DC Motor

Newton's Colour Disc for demonstrating additive combination of colours. Mounted on a stable box, moved by a DC motor.

Diameter of disc: 90 mm
 Motor: 4 – 6 V DC
 Connection: 4 mm safety sockets
 Dimensions: 135x85x130 mm³

P-1010175

Additionally required:

P-1002849 Pair of Safety Experiment Leads, 75 cm

P-1003560 DC Power Supply 1.5 – 15 V, 1.5 A (230 V, 50/60 Hz)



Newton's Colour Disc, with Crank

Newton's Colour Disc for demonstrating additive combination of colours. Mounted on a stable base, moved with crank.

Diameter of disc: 178 mm
 Dimensions of the base: 143x90x282 mm³

P-1010194



Newton's Colour Disc

Plastic, circular disc with segments coloured red, orange, yellow, light green, dark green, light blue, dark blue and violet for demonstrating additive combination of colours. When the disc is turned rapidly, its colours merge to produce white.

Diameter: 170 mm

P-1002983

Additionally required:

P-1002705 Motor with Drive Control

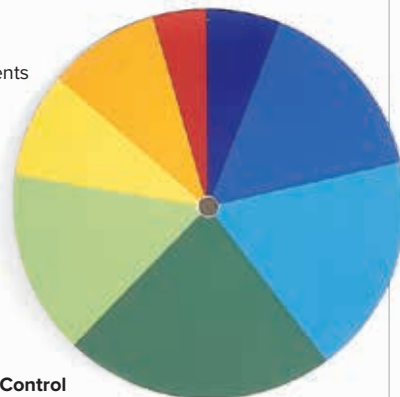

Motor with Drive Control

Controllable motor for spinning the colour disc fast (P-1002983). With disc holder and clamp for attachment to a stand rod. Includes plug-in power supply.

Control range: 0 – 25 rev/s
 Rotation direction: reversible
 Dimensions: approx. 110x70x45 mm³
 Weight: approx. 0.2 kg

P-1002705

Additionally recommended:

P-1002835 Tripod Stand, 150 mm

P-1002934 Stainless Steel Rod, 470 mm

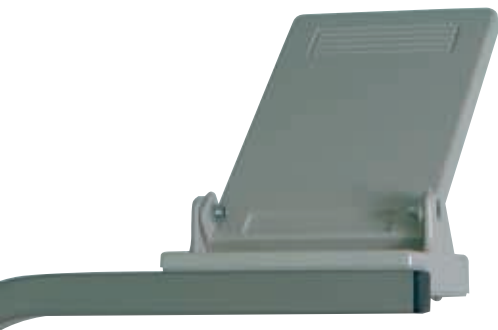

Equipment Set for Colour Mixing

Equipment set for demonstrating how colours combine (with the aid of an overhead projector). This equipment set is designed to permit quick setting up and safe, simple operation. The clear configuration facilitates understanding of the experiments and allows direct viewing of results. The projection plate, along with its three holders for mirrors and lenses, is placed onto the projection surface of the overhead projector. Depending on the projection distance, three large circles with diameters of 30 to 80 cm appear on the projection screen. By turning the holders and mirrors, it is possible to project colours so that they are separated or so that they partially overlap. Such adjustments can be performed easily and precisely. The large colour filters can be simply inserted into the lens holders, or placed directly on the overhead projector.

Experiment Topics:

- The three primary colours.
- Production of mixed colours through additive colour mixing.
- Primary colour components in a mixed colour.



Colour Mixing Device

Device for demonstrating additive mixing of the primary colours red, green and blue (RGB) to produce any colour shade using three LEDs (3W) as light sources. Three controllers allow continuous adjustment of LED intensity. The projection size at a given projection distance can also be continuously adjusted by means of a horizontal slider. In a black hexagonal aluminium housing. Including a threaded stem and a wide-range plug-in power supply (12V / 1A).

Stem: 130 mm x 10 mm Ø, with a thread (M4 x 6 mm)

Slider length: Max. 240 mm

Dimensions: Approx. 300x150x150 mm³

Weight: Approx. 780 g

P-1021719

Additionally required:

P-1002834 Barrel Foot, 1000 g

Experiment Topics:

- Additive colour mixing
- Subtractive colour mixing

Contents:

1 Projection plate with three mirror and lens holders

3 Colour filters; red, green, blue (120x50 mm²)

3 Colour filters; cyan, yellow, magenta (120x50 mm²)

P-1003189

Additionally required:

Overhead Projector

Light Speed Meter

Equipment set for determining the speed of light thanks to electronic run-time measurement. Comprises a compact housing containing a transmitter emitting short LED pulses, a photo receiver and a calibrated, oscillating quartz generator producing chronologically precise square-wave pulses. Emitted light pulses are returned by an internal reflector and by a triple-prism reflector placed a long distance from the light source. The returning light signals are then superimposed on the original signal. A dual-channel oscilloscope is used to measure the time difference between the two signals. The speed of light can be calculated from this difference and the distance to the triple-prism reflector. The triple-prism reflector can be installed by eye without the need for complex adjustments

Contents:

- 1 Control unit with a transmitter, receiver and integrated power supply unit
- 1 Fresnel lense on shaft
- 1 Triple-prism reflector on shaft
- 3 HF cables, 1 m

Light Speed Meter (230 V, 50/60 Hz)
P-1000882

Light Speed Meter (115 V, 50/60 Hz)
P-1000881

Additionally required:

- P-1020911 Digital Oscilloscope, 2x 100 MHz**
- Optical Bench**
- Optical Rider (2x)**
- Stand Equipment**

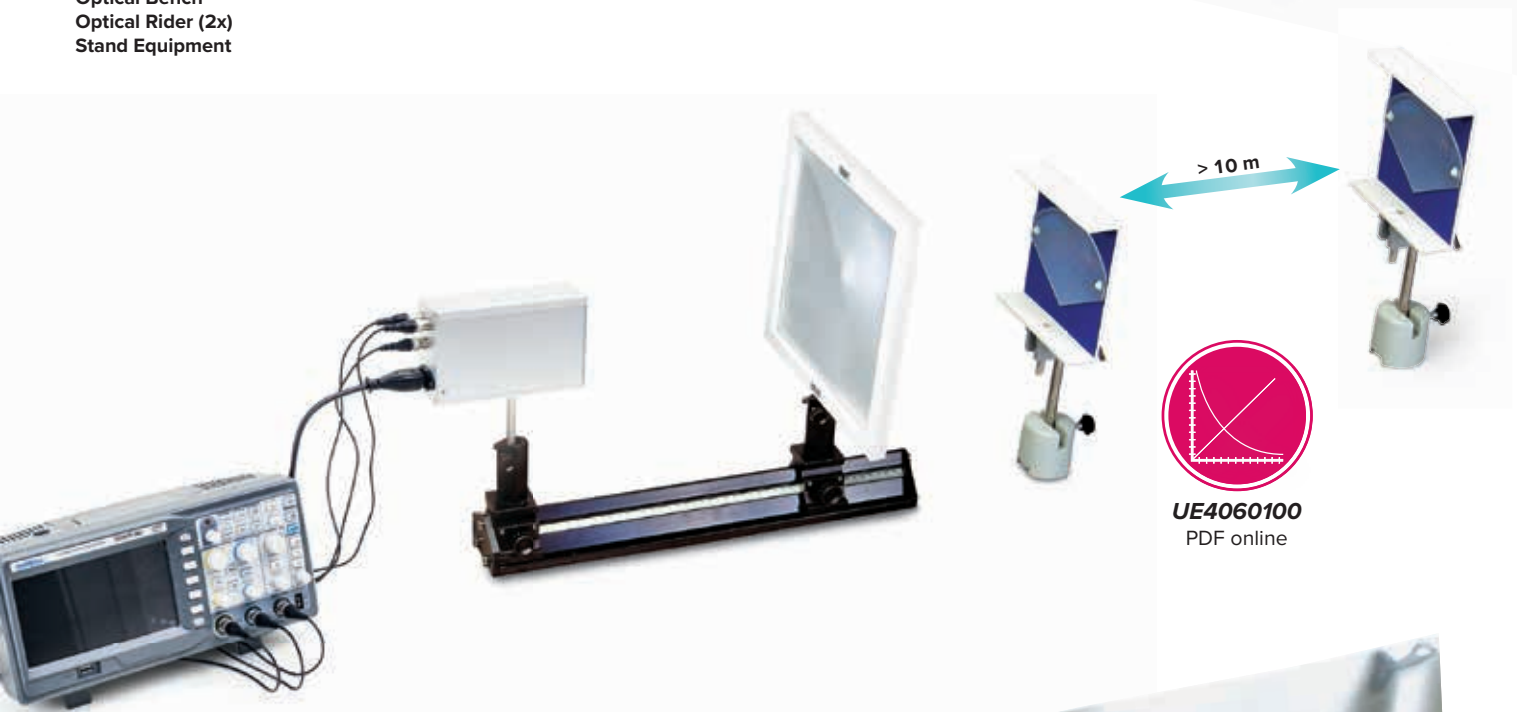

Funhouse Mirror 60x120 cm²

The Funhouse Mirror is a high grade polyester sheet with vacuum deposited silver metal surface. The mirror is 0.8 mm thick; it will not tear but can be cut with normal scissors. Keep out of sunlight as it can focus light and heat to start fires. Comes rolled into 4 cm tube, will unroll flat. This is a great way to teach concave and convex mirrors and real and virtual images. Many applications, use your imagination! For attachment to wall with double-sided adhesive tape.

P-1003339

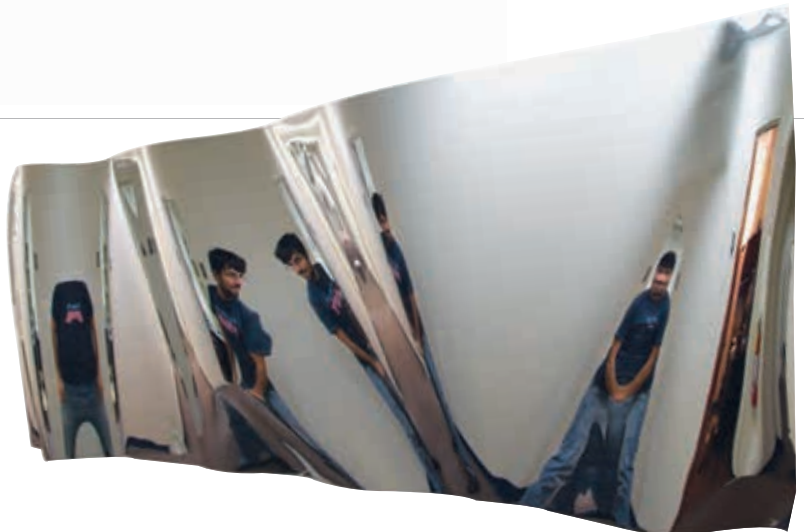

Experiment Topics:

- Demonstrate the Faraday effect in flint glass
- Measure the angle of rotation of the polarisation plane in the magnetic field
- Determine the Verdet constant for red and green light
- Determine the Cauchy coefficient b for the refractive index

Set-up for Faraday effect

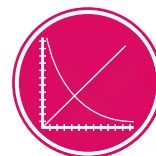
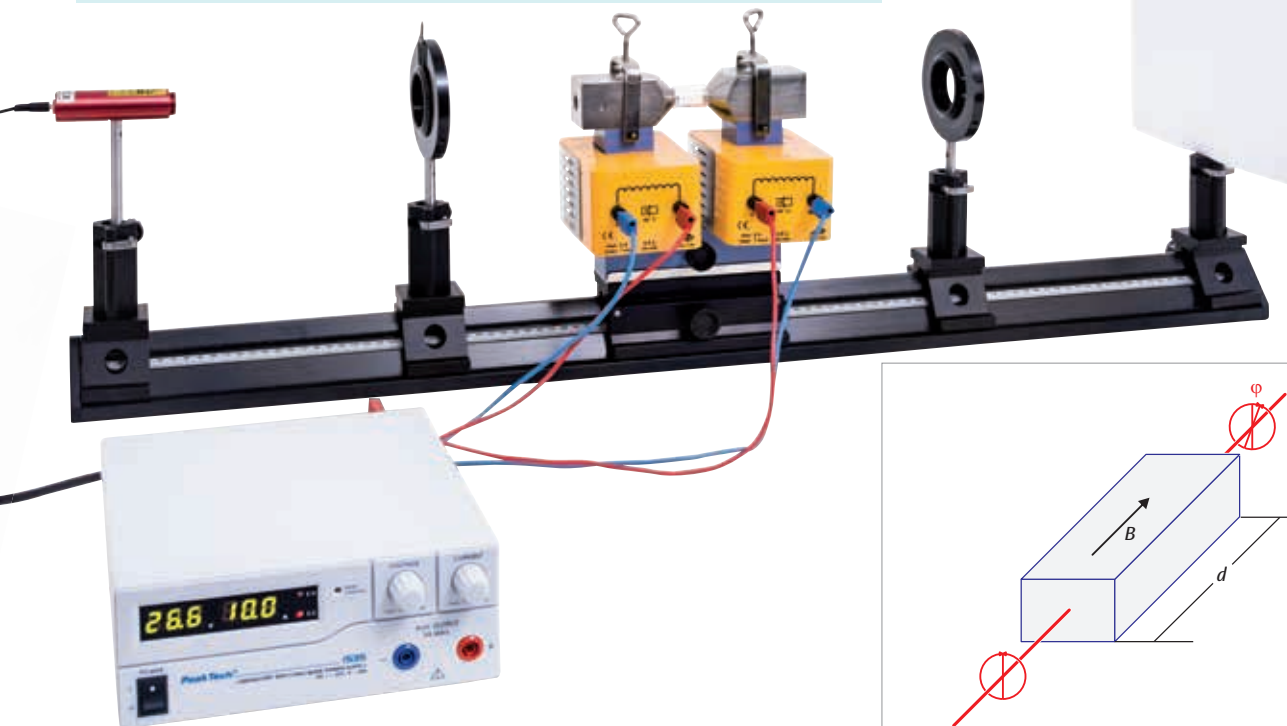

UE4040600
PDF online

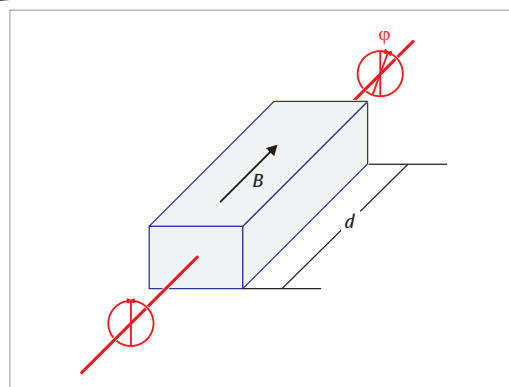

Schematic diagram to illustrate the Faraday effect

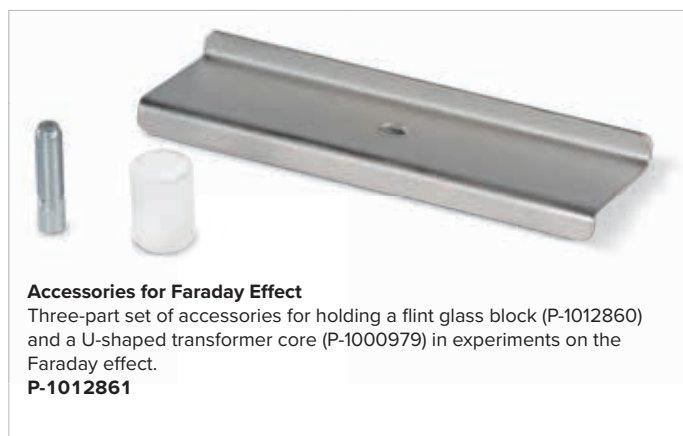

Accessories for Faraday Effect

Three-part set of accessories for holding a flint glass block (P-1012860) and a U-shaped transformer core (P-1000979) in experiments on the Faraday effect.

P-1012861

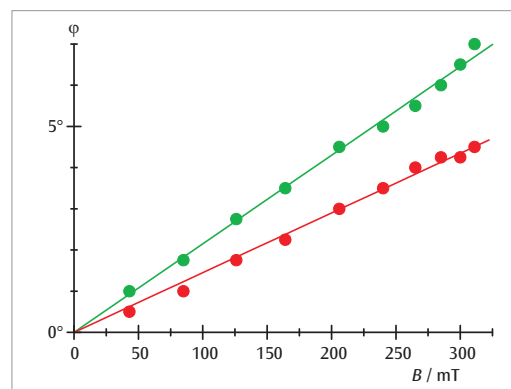

Angle of rotation as a function of the magnetic field for red and green laser light

Equipment for Faraday Effect:

- P-1002628 Optical Precision Bench D
 - P-1009733 Optical Base D
 - P-1012860 Flint Glass Block for Faraday Effect
 - P-1012861 Accessories for Faraday Effect
 - P-1000979 U Core
 - P-1000978 Pair of Pole Shoes
 - P-1000977 Pair of Clamps
 - P-1012859 Coil D 900 Turns (2x)
 - P-1012857 DC Power Supply 1 – 32 V, 0 – 20 A (230 V, 50/60 Hz)
 - or
 - P-1012858 DC Power Supply 1 – 32 V, 0 – 20 A (115 V, 50/60 Hz)
 - P-1002843 Set of 15 Safety Experiment Leads, 75 cm
 - P-1008668 Polarisation Filter on Stem (2x)
 - P-1002635 Optical Rider D, 90/50 (3x)
- Light source with colour filter or laser



Flint Glass Block for Faraday Effect

Rectangular block made of flint glass for demonstrating optical activity in a magnetic field (Faraday effect).

Dimensions: 20x10x10 mm³

P-1012860

Experiment Topics:

- Pockels effect (linear electro-optic effect)
- Photorefractive crystal with no inversion centre
- Occurrence and modification of double refraction in external electric fields
- Half-wave voltage
- Modulation of refractive index

Pockels Cell on Stem

Transverse Pockels cell for demonstrating linear electro-optic effect and measuring half-wave voltage of a lithium niobate crystal. With accurate, free-moving and smooth angle adjustment for demonstrating double refraction in conjunction with a polarisation filter used as an analyser.

Dimensions: approx. 156x26x218 mm³
Weight: approx. 206 g
Crystal: Lithium niobate (LiNbO₃), 20x2x2 mm³
Connectors: 4 mm safety sockets
P-1013393

Additionally recommended:

P-1002628 Optical Precision Bench D 1000 mm
P-1002635 Optical Rider D, 90/50 (3x)
P-1012401 Optical Rider D, 90/36 (2x)
P-1008668 Polarisation Filter on Stem
P-1000608 Projection Screen
P-1003165 He-Ne Laser
P-1005408 Achromatic Objective 10x / 0.25
P-1003022 Convex Lens on Stem f =+50 mm
P-1013412 High Voltage Power Supply E 5 kV (230 V, 50/60 Hz)
or
P-1017725 High Voltage Power Supply E 5 kV (115 V, 50/60 Hz)
P-1002849 Pair of Safety Experiment Leads, 75 cm

! Advantage
• With accurate, free-moving and smooth angle adjustment

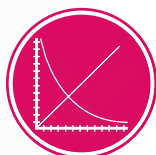

UE4040500
PDF online

Demonstration of the Pockels effect in a conoscopic light beam

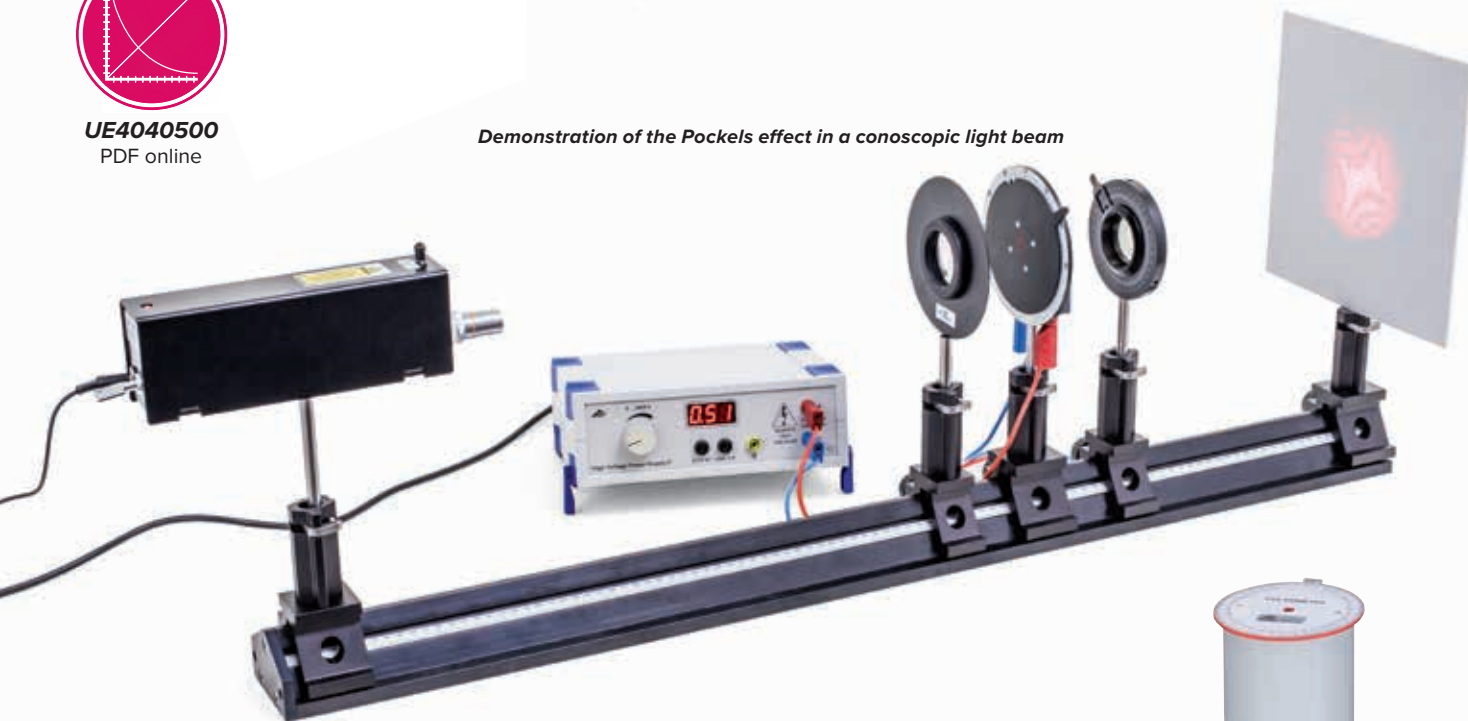

Polarimeter with 4 LEDs

Polarimeter with a lighting unit comprising four monochromatic LEDs for determining the angle and direction of rotation of polarised light as a function of wavelength as well as sample thickness and concentration with the help of an optically active substance. The light emerging from those LEDs that are lit is polarised linearly and transmitted through a fitted sample cylinder filled with the optically active substance. The analyser in the cover is used to identify the direction of polarisation which can be read on the cover's angle scale.

Wavelength of LEDs: 468 nm (blue), 525 nm (green),
580 nm (yellow), 630 nm (red)
Dimensions: approx. 110x190x320 mm³
Weight: approx. 1 kg

P-1001057

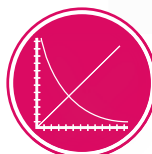

UE4040300
PDF online



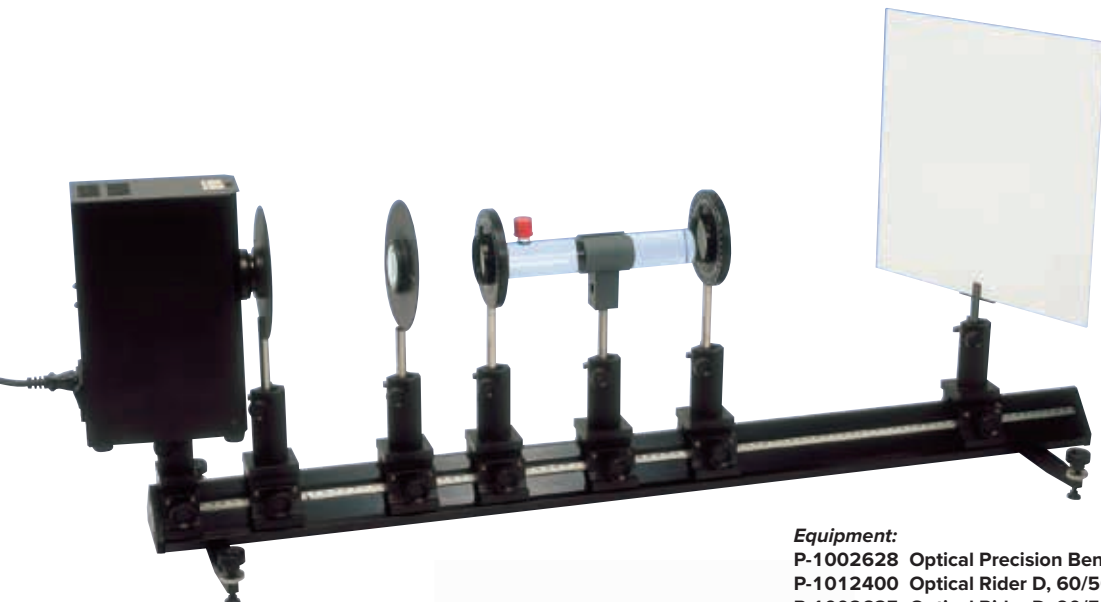

Determination of the angle of rotation of optically active substances

Round Cells

Duran glass cells with bonded optical discs and GL threads. E.g. for experiments on the determination of the angle of rotation of optically active substances on the optical bench.

Diameter: 35 mm
Thread: GL-14

Round Cell, 100 mm
P-1002884

Round Cell, 200 mm
P-1002885



Equipment:

- P-1002628 Optical Precision Bench D, 1000 mm
- P-1012400 Optical Rider D, 60/50 (2x)
- P-1002635 Optical Rider D, 90/50 (5x)
- P-1002721 Cell Holder on Stem
- P-1002884 Round Cell, 200 mm
- P-1002885 Round Cell, 100 mm
- P-1003017 Iris Diaphragm on Stem
- P-1003022 Convex Lens on Stem, $f = 50$ mm
- P-1000608 Projection Screen
- P-1008668 Polarisation Filter on Stem (2x)
- P-1003159 Na Low-Pressure Spectral Lamp (230 V, 50/60 Hz)

Cell Holder on Stem

Plastic holder for round cells (P-1002884) and (P-1002885).
Holder: 36 mm diam.
Stem: 90 mm x 10 mm diam.

P-1002721



Polarimeter

Polarimeter with a sodium lamp as the light source for the measurement of the rotation and the rotation direction of the polarisation plane of polarised light through optically active substances as well as the determination of the concentration of liquids. Robust metal stand with slightly tilted shaft for tubes with lengths up to 220 mm. With swivel cover, analyser and polariser. A sodium lamp with filter holder is used as a light source. Includes polarimeter tubes 100 mm, 200 mm and spare sodium lamp.

Measurement range: 2 semi-circles (0 – 180°)
Glass tubes: 100 and 200 mm, 15 mm diam.
Scale division: 1°
Readability: 0.05° (with Vernier scale)
Dimensions: 200x360x450 mm³
Weight: approx. 10 kg
Light source: Sodium lamp (589 nm)
Mains voltage: 115 V – 230 V, 50/60 Hz

P-1008696

Spare Sodium Lamp (not shown)

Spare lamp for polarimeter (P-1008696).
P-1012885



Polarimeter Tube 100 mm
(not shown)

Spare glass tube for polarimeter (P-1008696).
Length: 100 mm, 15 mm diam.
P-1012883

Polarimeter Tube 200 mm
(not shown)

Spare glass tube for polarimeter (P-1008696).
Length: 200 mm, 15 mm diam.
P-1012884



Control Unit for Spectrum Lamps

Control unit for operating spectral lamps (P-1003537 – P-1003546), including a lamp housing on a stand rod. A second lamp housing on a stand rod can be clamped to the rear side of the stable metal housing and connected to the electricity supply. A switch on the front can be used to change over between the right-hand and left-hand spectral lamps.

Maximum output current: 1 A
 Lamp housing: 180 mm x 50 mm diam.
 Tripod rod: 300 mm x 10 mm diam.
 Lamp socket: Pico 9
 Dimensions: approx. 255x175x135 mm³
 Weight: approx. 5.3 kg

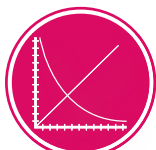

UE5020150
 PDF online



Contents:

- 1 Control unit
- 1 Lamp housing on a stand rod with a 7-pole connection cable

Control Unit for Spectrum Lamps (230 V, 50/60 Hz) P-1021409

Control Unit for Spectrum Lamps (115 V, 50/60 Hz) P-1003195

Additionally recommended:

P-1003197 Lamp Housing on a Stand Rod

Lamp Housing on a Stand Rod (not shown)

Additional lamp housing with a cable for connecting to a spectral lamp ballast coil (P-1021409 resp. P-1003195).

P-1003197

Spectral Lamps

Gas discharge lamps for emitting line spectra of inert gases and metal vapours with high luminance and spectral purity.

Socket: Pico 9
 Operating current: max. 1 A
 Weight: approx. 350 g

Spectral lamps may only be operated with the control unit for spectral lamps (P-1021409 or P-1003195).

Spectrum Tube Power Supply

Control unit for stable operation of spectral tubes (P-1003402 – P-1003417). The integrated current limiter ensures a long service life of the tubes. Spring-contacts in fully insulated fixtures and a protective window guarantee secure mounting and reliable operation.

Voltage: 5000 V
 Maximum current: 10 mA
 Dimensions: approx. 370x120x90 mm³

Spectrum Tube Power Supply (230 V, 50/60 Hz) P-1000684

Spectrum Tube Power Supply (115 V, 50/60 Hz) P-1000683



Art. No.	Filling
P-1003537	Cd
P-1003539	He
P-1003541	Na
P-1003543	Ne
P-1003544	Tl
P-1003545	Hg 100
P-1003546	Hg/Cd

Additionally required:

- P-1021409 Control Unit for Spectrum Lamps (230 V, 50/60 Hz)
- or
- P-1003195 Control Unit for Spectrum Lamps (115 V, 50/60 Hz)

Spectrum Tubes

High luminance spectral tubes emitting the line or band spectrum of a gas or mercury vapour. Partly evacuated capillary glass tubes filled with gas or mercury vapour are furnished with electrodes for the application of a voltage to generate the electrical field that provides the necessary energy.

Capillary length: 100 mm
 Total length: approx. 260 mm

Additionally required:

- P-1000684 Spectrum Tube Power Supply (230 V, 50/60 Hz)
- or
- P-1000683 Spectrum Tube Power Supply (115 V, 50/60 Hz)

Recording the line spectrum of hydrogen

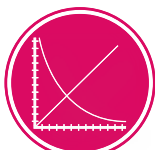

UE5020100
 PDF online



Art. No.	Filling
P-1003402	Air
P-1003403	Argon
P-1003404	Bromine
P-1003405	Carbon dioxide
P-1003406	Chlorine
P-1003407	Deuterium
P-1003408	Helium
P-1003409	Hydrogen
P-1003410	Iodine
P-1003411	Krypton
P-1003412	Mercury
P-1003413	Neon
P-1003414	Nitrogen
P-1003415	Oxygen
P-1003416	Water vapor
P-1003417	Xenon

High-Pressure Mercury Spectral Lamp (230 V, 50/60 Hz)

Gas discharge lamp for observing high-intensity mercury spectral lines at high vapour pressures. Lines in the ultra-violet range are suppressed by the glass body. Includes a black metal housing with integrated power supply unit, a light aperture with a fine thread for direct screw-mounting of filters and a threaded stand rod.

Luminance: 1800 lm
 Operating current: 0.6 A
 Power: 50 W
 Base: E27
 Service life: approx. 24000 h
 Threaded light aperture: 40 mm diam.
 Fine thread for filter: M49
 Dimensions: approx. 295x165x85 mm³
 Weight: approx. 1.5 kg

P-1003157



Low-Pressure Mercury Spectral Lamp (230 V, 50/60 Hz)

Gas discharge lamp for observing mercury spectral lines at low vapour pressures with optimal line widths. The body is made of quartz glass to allow detection of lines in the ultra-violet range too. Includes a black metal housing with integrated power supply unit, a light aperture with a fine thread for direct screw-mounting of filters and a threaded stand rod.

Operating current: 0.16 A
 Power: 6 W
 Base: G5
 Service life: approx. 3000 h
 Threaded light aperture: 40 mm diam.
 Fine thread for filter: M49
 Dimensions: approx. 295x165x85 mm³
 Weight: approx. 1.5 kg

P-1003158

Low-Pressure Sodium Spectral Lamp (230 V, 50/60 Hz)

Gas discharge lamp for observing Na D lines and investigating of the doublet. Includes a black metal housing with integrated power supply unit, a light aperture with a fine thread for direct screw-mounting of filters and a threaded stand rod.

Luminance: 1800 lm
 Operating current: 0.35 A
 Power: 18 W
 Base: BY22d
 Service life: approx. 10000 h
 Threaded light aperture: 40 mm diam.
 Fine thread for filter: M49
 Dimensions: approx. 295x165x85 mm³
 Weight: approx. 1.5 kg

P-1003159

Spare Lamps: (not shown)

Art. No.	Description
P-1003161	Hg High-Pressure Spectral Lamp for P-1003157
P-1003162	Hg Low-Pressure Spectral Lamp for P-1003158
P-1003163	Na Low-Pressure Spectral Lamp for P-1003159



Line spectra of Hg (high-pressure) and Na, recorded using the digital spectrometer

High-Pressure Mercury Vapour Lamp

High-pressure mercury vapour lamp in hardened glass bulb made of blackened borosilicate glass, with tube-shaped hole allowing emission of unfiltered ultra-violet radiation. Includes E27 lamp holder on stem and see-through screen to protect users from UV radiation.

Wavelength ranges: UV-A, UV-B, UV-C
 Power consumption: 125 W

P-1000852

Additionally required:

P-1021409 Control Unit for Spectrum Lamps
(230 V, 50/60 Hz)

or

P-1003195 Control Unit for Spectrum Lamps
(115 V, 50/60 Hz)





Handheld Spectroscope

Device for observing absorption and emission spectra, e.g. to observe the Fraunhofer line spectrum in sunlight for the observation of absorption spectra through liquids, the emission spectra of gas discharge tubes or for chemical analysis during flame tests.

Spectroscope in Cardboard Box

Hand spectroscope in a flat cardboard box with printed wavelength scale for easy reading of spectral lines and spectra.

Dimensions: approx. 180x115x25 mm³

P-1003183



Pocket Spectroscope

High quality optical system with centered visible spectrum, which is linear with respect to the wavelength. In metal sleeve. With fixed slit and prism system with grating

Slit width: 0.2 mm

Number of grating lines: 600 lines/mm

Dimensions: approx. 115 mm x 25 mm diam.

Weight: approx. 62 g

P-1003078



Spectroscope in Metal Case

Hand spectroscope in a flat metal case with printed wavelength scale for easy reading of spectral lines and spectra. With holder for mounting a probe in a plastic vessel.

Dimensions: approx. 180x115x25 mm³

P-1003184



Hand Spectroscope with an Amici Prism

Precise optical system with a visible spectrum that is linear in terms of wavelength around the centre point. In a metal housing with an adjustable slit and high-grade Amici prism. Delivery in hinged case for protective and dust-free storage.

Angular dispersion: 7° (C-F)

Linear dispersion: 60 mm

Slit width: 0 – 1 mm

Folding case: approx. 150x70x30 mm³

Weight: approx. 150 g

P-1003531

Spectrometer-Goniometer S

Spectrometer with rotatable prism or grating and directionally-adjustable objective tube for observing and measuring emission and absorption spectra. Can also be used for precise determination of the optical parameters of prisms or gratings. Includes prism with holder and transmission grating with holder.

Objective tube: Adjustable slit width and object distance; f = 175 mm, 32 mm diam.

Eyepiece tube: Continuous focusing and viewing angle adjustment, eyepiece with cross-wire, f = 175 mm, 32 mm diam.

Prism: flint glass (60°)

Dispersion ($n_F - n_C$): 0.017

Base length: 40 mm

Height: 40 mm

Transmission grating: 300 lines/mm

Angular scale: 0° to 360°

Scale divisions: 0.5°

Reading precision: 0.5' (Vernier scale)

Height: 250 mm

Weight: approx. 12 kg

P-1008673



Kirchhoff-Bunsen Spectroscope

Desktop spectroscope for the observation and measurement of emission and absorption spectra. With adjustable slit, condenser, flint glass prism as well as an observation telescope with sliding ocular. Scale tube with reference division, which is superimposed on the image plane of the spectrum due to reflection at the front surface of the prism. Includes removable prism hood. Ideal for schools and universities.

Observation tube: moveable, with locking screw, slideable eyepiece

Objective: f = 160 mm, 18 mm diam.

Slit tube: stationary, with symmetrical slit

Objective: f = 160 mm, 18 mm diam.

Scale tube: stationary, 200-division scale

Eyepiece: f = 90 mm, 18 mm diam.

Scale: can be calibrated in wavelengths

Prism: Flint glass (60°), Dispersion ($n_F - n_C$): 0.017

Length of base: 20 mm, height: 30 mm

Weight: 4.8 kg

P-1002911

Analog Abbe Refractometer ORT 1RS

Easy-to-operate universal analog refractometer for efficient and extremely reliable usage. Liquid, solid or paste-like substances can all be analysed. Built-in scale allows for use in many applications and offers optimum safety for reading measurement results with precision. Includes thermometer.

Also included:

Calibration solution, calibration block, pipette, screwdriver and cleaning cloth.

Scales: Brix, refractive index

Measuring range: 0 – 95%, 1.3000 – 1.7000 nD

Accuracy: ±0.1%, ± 0.0002 nD

Divisions: 0.25%, 0.0005 nD

Dimensions: approx. 180x90x240 mm³

Weight: approx. 1.95 kg

P-1021250





Advantages

- **Plug & play: no software installation or drivers required**
- **Connect up your spectrometer and the spectrum is obtained immediately**
- **Measurement and evaluation in real-time**
- **Simple and practical software with built-in wizards and powerful evaluation functions**
- **Internal memory for measured data**
- **Spectra of high quality and signal stability**
- **Highly stable metal casing with built-in entry slit**
- **Internal beam paths and the principle of operation can be viewed by opening the lid of the casing**

Digital Spectrometer

Digital spectrometer for quantitative analysis of emission and absorption spectra, for recording transmission curves and performing measurements in calorimetry and kinetics. Incident light from a fibre-optic cable is dispersed into a spectrum by a Czerny-Turner monochromator and projected from there onto a CCD detector. The entry slit is built into the casing. User-friendly measurement and evaluation software enable simultaneous recording and analysis in real-time. The built-in software for Windows 2000/XP/Vista/7/8 32- and 64-bit versions starts running as soon as the sensor is connected to the computer via a USB cable. Includes plug-in power supply and holder for fibre-optic cable.

CCD detector:	3600 pixels
Resolution:	16 bit
Integration time:	0.1 to 60 s
Entry slit:	40 μm metal
Interface:	USB 2.0
Connectors:	SMA 905
Fibre-optic cable:	2 m
Mains voltage:	100 – 240 V
Dimensions:	approx. 133x120x60 mm ³
Weight:	approx. 950 g

Digital Spectrometer HD

Grating:	1200 lines/mm
Spectral range:	400 – 700 nm
Spectral resolution:	0.5 nm (for resolution of sodium doublet)
Accuracy:	1 pixel per 0.08 nm

P-1018104

Experiment Topics:

- Line spectra, continuous spectra
- Black-body radiators, Wien's law
- Emission spectrum of sodium
- Flame spectra
- Transmission spectra of solid bodies and liquids
- Kinetics
- Beer-Lambert law

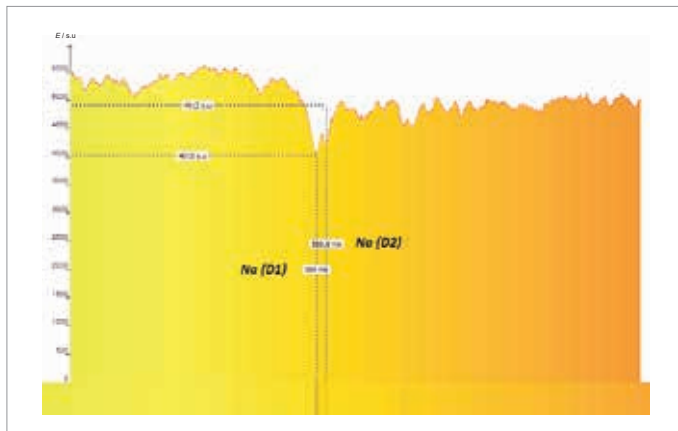

Sodium absorption lines in the spectrum of the sun (resolution of sodium doublet), observed using digital spectrometer HD.

Digital Spectrometer LD

Grating:	600 lines/mm
Spectral range:	350 – 900 nm
Spectral resolution:	1 nm (for resolution of mercury doublet)
Accuracy:	1 pixel per 0.15 nm

P-1018103

Digital Spectrometer LD with Absorption Chamber (p. 181)

P-1019196

Additionally recommended:

P-1018106 Set of 100 Cuvette Cells, 4 ml

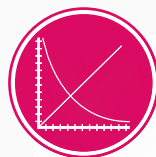

UE5020100

UE5020150

PDF online

Digital Spectrometer LD with Absorption Chamber

Digital Spectrometer LD (P-1018103, see p.180) with absorption chamber. The absorption chamber is a multi-functional module for recording transmission or absorption measurements using 4-ml cells (10x10x40 mm³), objects in slide format (50x50 mm²) or objects in coin format (40 mm diam.). Up to two slide-format objects and one coin-format object can be analysed simultaneously and compared. With built-in light source for the spectral region from 350 – 1000 nm. In metal casing resistant to chemicals. For direct connection to digital spectrometers LD via fibre-optic cable. Refer also to experiment UE4020400.

Absorption chamber:

Light source: 350 – 1000 nm
 Power supply: 12 V (via adaptor cable from plug-in power supply for digital spectrometer)
 Dimensions: approx. 65x100x55 mm³
 Weight: approx. 250 g

P-1019196

Additionally recommended:

P-1018106 Set of 100 Cuvette Cells, 4 ml

Set of 100 Cuvette Cells, 4 ml (not shown)

Set of 100 disposable cuvette cells for use in absorption chamber for digital spectrometers LD (P-1019196).

Dimensions: 10x10x40 mm³

P-1018106



Recording the transmission spectra of colour filters.

Spectrophotometer S

Robust spectrometer for investigating the near infra-red and infra-red regions of the spectrum between 360 and 800 nm. Its removable covers allow students to see first hand the spectrum analysis process. Setup is quick and easy. The optical signal enters the device through a flexible fibre optic cable. Connection to a PC is via the USB 2.0 interface. A specially selected transmission grating and precision slit gives high resolution and excellent results. Data collection software is intuitive with real time graphical output. For easier interpretation of the spectrum, each wave band is shaded with the corresponding colour. The spectrum can be viewed either as a graph or in text form, which allows for more advanced calculations. The availability of several toolbars makes it possible to set the spectrometer parameters to exactly fit the requirements of the experiment. Spectrometer S is supplied ready to use; tested and calibrated.

Spectral range: 360 – 800 nm
 Spectrometer resolution: < 2.0 nm
 Pixel resolution: < 0.5 nm
 Operating system: Win XP, Vista, Win7
 Interface: USB 2.0
 Dimensions: approx. 60x60x120 mm³
 Weight: approx. 600 g

Contents:

Spectrophotometer S with USB cable, fibre optic cable, and a CD containing experimental software and an instruction manual. Laptop not included.

P-1003061



Experiment Topics:

- Mach-Zehnder interferometer
- Changes in polarisation at beam splitter and mirror surface
- Demonstration analogous with quantum eraser experiment
- Determination of the refractive index of glass*
- Determination of the refractive index of air*
- Twyman-Green test for optical components (qualitative)*

* Accessory set (P-1002652) required

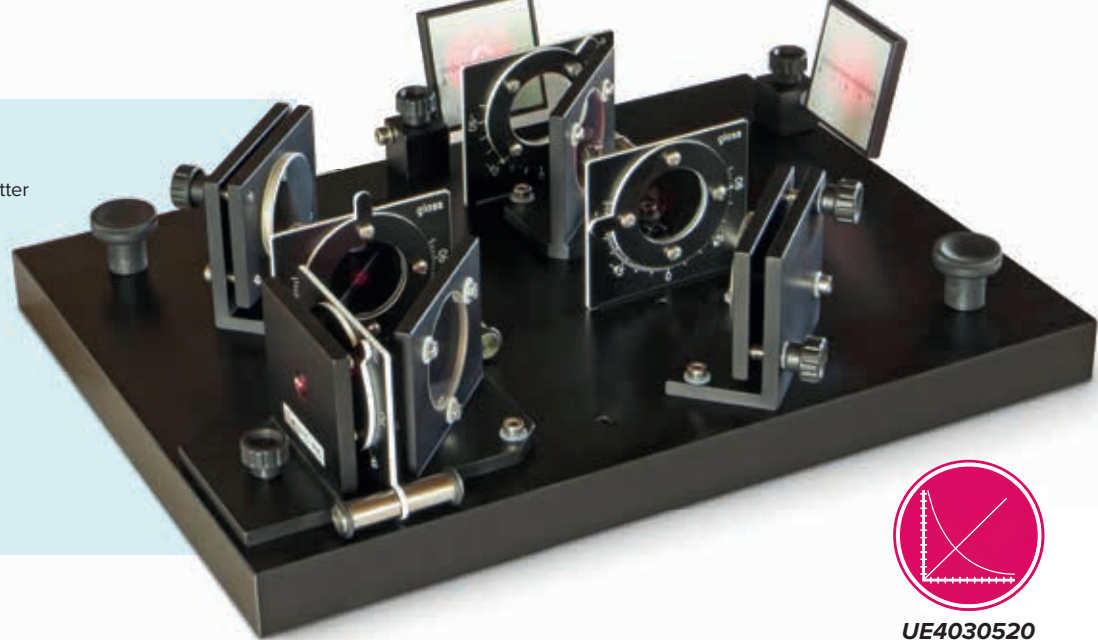

UE4030520
PDF online

Mach-Zehnder Interferometer

Complete equipment set consisting of two beam splitters, two surface-coated mirrors, two observation screens and four polarisation filters. The high-grade optical components mounted on a heavy, rigid base plate for precise and reproducible measurements. Beyond the first beam splitter, the two parts of the split beam take different paths to the second beam splitter, where they are once again superimposed. This means that by adding in polarisation filters, it is possible for the two beams to be differently polarised. The large optical components permit a generation of clear and well-defined interference patterns, which can even be viewed in daylight as the tilt of the two reflecting observation screens can be adjusted. Pre-defined component positions allow quick rearrangement to ensure extremely rapid preparation for the various experiments. The equipment set includes a stable plastic box for storing the mounted and adjusted interferometer as well as the base plate for laser.

Beam splitter:

Diameter: 40 mm
Evenness: $\lambda/10$ (front side), $\lambda/4$ (rear side)

Surface-coated mirror:

Dimensions: 40x40 mm²
Evenness: $<\lambda/2$

Polarisation filter:

Diameter: 30 mm
Adjustable range: $\pm 105^\circ$
Material: Glass (2x), foil (2x)
Angular graduation: 3°, 15°

Base plate:

Weight: approx. 5.5 kg
Dimensions: approx. 245x330x25 mm³

P-1014617

Additionally required:

P-1003165 He-Ne-Laser

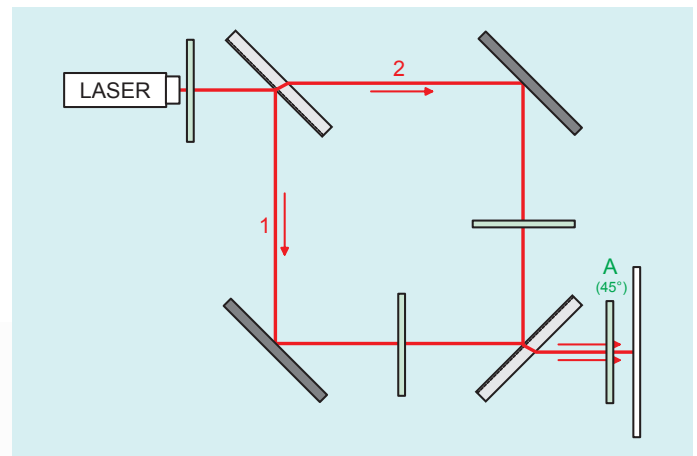

Paths through the Mach-Zehnder interferometer (polariser A “erases” the path information)

Optical Lamp with Pinhole Aperture

High quality source of white light with a pinhole aperture fitting which can be rotated and latches into position. Includes matching base for use with Mach-Zehnder or Michelson interferometers.

Light source: LED, 2x2 mm² light-emitting surface
Light intensity: 289 lumen
Pinholes: 0.5/0.7/1.0/1.4/2.0/2.8/4.0/5.7/8.0/16 mm

P-1017284



Experiment Topics:

- Michelson Interferometer
- Fabry-Perot Interferometer
- Determination of the refractive index of glass*
- Determination of the refractive index of air*
- Twyman-Green test for optical components (qualitative)*

* Accessory set (P-1002652) required

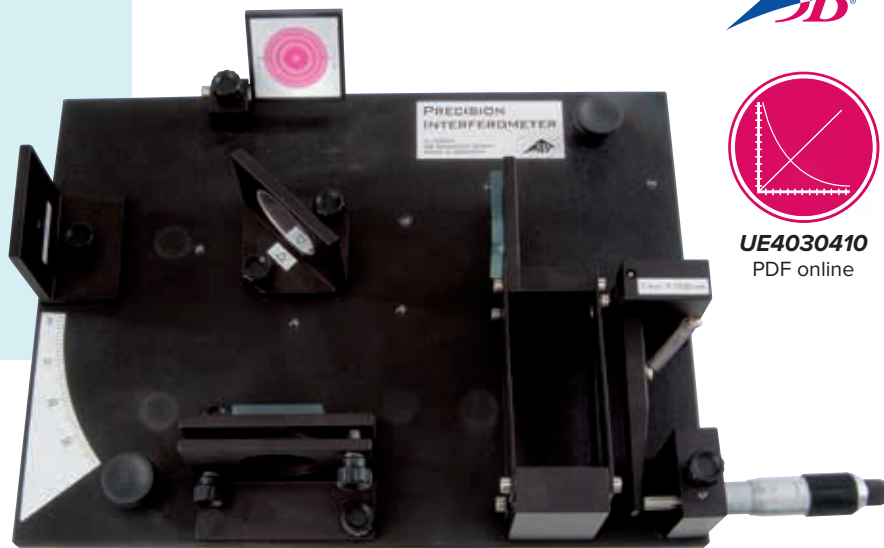

Interferometer

This complete equipment set comprises high grade optical components mounted on a heavy, rigid base plate for precise and reproducible measurements. The large optical components permit a generation of clear and well defined interference patterns in daylight. The reflective observation screen has an adjustable inclination. Pre-defined component positions allow quick rearrangement to ensure extremely rapid preparation for the various experiments. The equipment set includes a stable plastic box for storing the mounted and adjusted interferometer as well as the base plate for laser.

Beam splitter:

Diameter: 40 mm
Evenness: $\lambda/10$ (front side), $\lambda/4$ (rear side)

Surface-coated mirror:

Dimensions 40x40 mm²
Evenness: $<\lambda/2$

Accessory Set for the Interferometer

This accessory set for the interferometer (P-1002651) consists of a vacuum cell for determining the refractive index of air and a glass plate on a rotatable holder for determining the refractive index of glass and investigating the surface quality of optical components (Twyman-Green interferometer).

P-1002652

Additionally required:

P-1012856 Vacuum Hand Pump

P-1002622 Silicone Tube

Mirror adjustment:

Eccentric reduction: approx. 1:1000 (individual calibration specified on eccentric base)

Base plate:

Weight: approx. 5.5 kg
Dimensions: approx. 245x330x25 mm³

P-1002651

Additionally required:

P-1003165 He-Ne Laser



Glass plate in the beam path of the Michelson interferometer

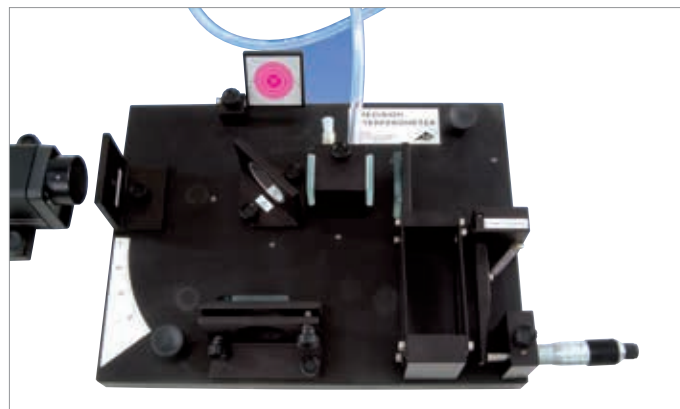

Vacuum chamber in the beam path of the Michelson interferometer

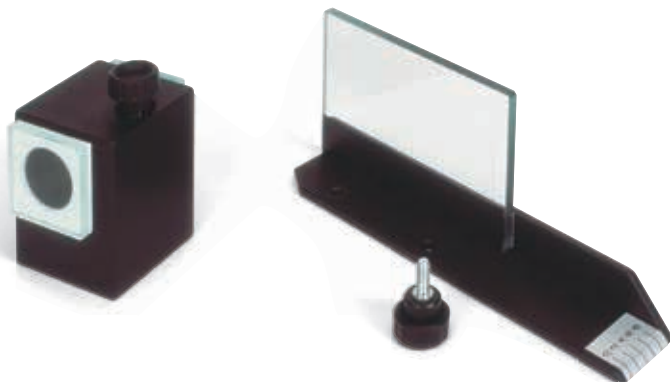



Advantages

- Precise, safe and inexpensive solution for the operation of continuous wave (cw) and pulsed diode lasers.
- Precise current-controlled continuous wave and pulse-type laser driver
- Two TEC (Thermo Electric Cooler) drivers with PID controllers
- Digital and analogue modulation inputs

- Multiple safety circuits
- Stored configuration (EEPROM)
- Very low power dissipation due to bias voltage control in cw-mode
- Digital control using isolated RS232 serial interface

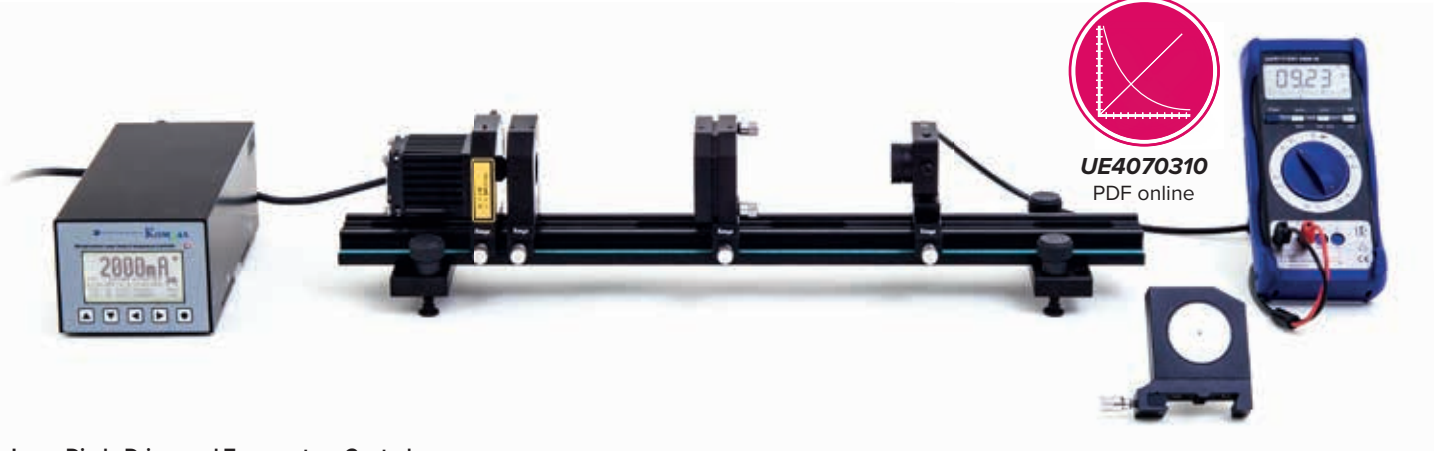

Laser Diode Driver and Temperature Control

Power supply for current-stabilised control of laser diode using control unit to control the power of the optical beam from the laser diode in cw mode by means of the built-in photodiode input. In pulsed mode the laser diode can be operated with the freely configurable built-in oscillator or externally using the modulation input. The temperature controllers are designed as PID controllers and configured for standard operation with NTC and Pt100 sensors. The use of silicon temperature sensors or other types is equally possible simply by altering the software configuration.

P-1008632

Laser:

Laser current range: 0 – 2500 mA
 Laser current resolution: 1 mA
 Laser current accuracy: <1 mA
 Laser current noise: <60 μ s
 Pulse rise time: <10 μ s
 Pulse fall time: <5 μ s
 Voltage range: 1.2 – 5 V
 Current limit: adjustable between 0 – 2500 mA
 External digital modulation input: TTL

TEC Driver:

Peltier current: max. -4 – +4 A
 Peltier current (2nd driver): max. -2 – +2 A
 Peltier voltage: max. 8 V
 Peltier current limit: adjustable between 0 – 4 A
 Peltier current limit (2nd driver): adjustable between 0 – 2 A
 Peltier current resolution: 1 mA
 Temperature control accuracy: <10 mK

General specs:

Over-temperature protection: for driver and laser
 Mains voltage: 100 up to 240 V AC
 Dimensions: 88x110x240 mm³

Optical Bench KL

Profile rail with levelling platform, 600 mm.
P-1008642

Nd:YAG-Module

Module with Nd:YAG crystal to act as an active laser medium with dielectrically coated surface for reflecting the laser wavelength (1064 nm) during simultaneous transmission of the pumping wavelength (808 nm). On rider for optical bench KL.
P-1008635



Laser Safety Goggles for Nd:YAG Laser

Nylon goggles for average protection levels, integral construction for reduced weight with enlarged visual field due to large filter lenses. Supplied in a storage pouch.

Filter colour: light blue
 Degree of light transmission: $T_{D65} = 62\%$
 Specification according to DIN EN 207/208: 750 – 1100 D L5 + IR
 L7 > 1100 – 1200 DIR L5

P-1002866

Infra-Red Detector Card (not shown)

Converter card for converting infra-red light into visible light. Held directly in a laser to act as a sensor.

Dimensions: 90x60 mm²

P-1017879

Safety instructions:

The system described here is a class four laser. The laser light emitted is not visible to the naked eye but is nevertheless highly hazardous for eyes and also dangerous for skin. It can also cause fires or explosions.

- Observe safety regulations for class 4 lasers
- Always wear goggles which can protect you from laser beams
- Even with protective goggles, do not look straight into the laser beam.



A. Cr:YAG-Module

Module with Cr:YAG crystal for passive Q-switch circuit. On rider for optical bench KL.

P-1008637

B. Collimator Lens, $f = +75$ mm

Collimator lens, $f = +75$ mm, with anti-reflective coating on both sides. On rider for optical bench KL.

P-1008646



C. Alignment Laser Diode

Tunable laser diode, on rider for optical bench KL.

Wavelength: 633 nm

Power: 1 mW

P-1008634

D. PIN Photodiode DET 36 A/M

PIN photodiode in casing with thread for accommodating filters. On rider for optical bench KL.

Rise time/fall time: <14 ns

Wavelength range: 350 – 1100 nm

Detector surface: 13 mm²

Battery: E23, 12 V

P-1008640

Filter RG850 (not shown)

RG850 filter for suppressing pumping radiation. In holder with screw thread.

P-1008648

Filter BG40 (not shown)

BG40 filter for suppressing fundamental wavelength. In holder with screw thread.

P-1017874

Transport Case KL (not shown)

Padded transport case for all solid body laser components.

P-1008651

Diode Laser 1000 mW

1000 mW diode laser for optical pumping of Nd:YAG laser. With built-in Peltier cooler and thermistor plus collimating and focussing lens.

On rider for optical bench KL.

Emission wavelength: 808 nm

P-1009497



Frequency Doubling Module

Module with KTP crystal (potassium titanyl phosphate) for use as a non-linear optical element for frequency doubling, featuring built-in Peltier cooler and thermistor. In rotating holder on rider for optical bench KL.

P-1008636

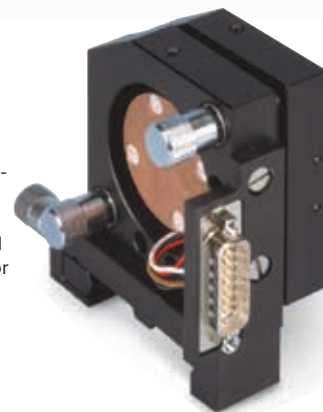

Laser Mirror

Mirror for laser light of wavelength 1064 nm with spherical curvature. Includes adjustment mounting, on rider for optical bench KL.

Radius of curvature: -200 mm

Reflection coefficient: 97%

P-1008638



Laser Mirror HAT, 532 nm (not shown)

Mirror for laser light with spherical curvature for decoupling frequency-doubled laser beams of wavelength 532 nm. Includes adjustment mounting, on rider for optical bench KL.

Radius of curvature: -200 mm

P-1008639

PIN Photodiode DET 10 A/M (not shown)

PIN photodiode in casing with thread for accommodating filters. On rider for optical bench KL.

Rise time/fall time: <1 ns

Wavelength range: 200 – 1100 nm

Detector surface: 0.8 mm²

Battery: E23, 12 V

P-1008641

Experiment: "Tuning of Diode Laser for Stable Optical Pumping"

- Measurement of output power of diode laser as a function of applied current.
- Determination of how wavelength depends on temperature.
- Determination of how wavelength depends on injection current.
- Determination of injection current-temperature curve at constant wavelength (maximum absorption).

Experiment: "Set-Up and Optimisation of Nd:YAG Laser"

- Tuning of diode laser for stable optical pumping of Nd:YAG laser.
- Determination of lifetime of the upper laser level ${}^4F_{3/2}$ in an Nd:YAG crystal.
- Adjustment of resonator and observation of resonator modes.
- Measurement of output power of Nd:YAG laser as a function of pumping power and determination of laser threshold.
- Observation of spiking in pulsed operation of laser diode.

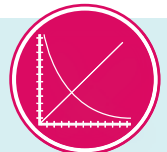

UE4070310
PDF online

Number / Description	Art. No.
1 Laser Diode Driver and Temperature Controller	P-1008632
1 Diode Laser 1000 mW	P-1009497
1 Nd:YAG Module	P-1008635
1 Alignment Laser Diode	P-1008634
1 PIN Photodiode DET 36 A/M	P-1008640
2 Collimator Lens, f = +75 mm	P-1008646
1 Filter RG850	P-1008648
1 Optical Bench KL	P-1008642
1 Transport Case KL	P-1008651
1 Laser Safety Goggles for Nd:YAG Laser	P-1002866
1 Infra-Red Detector Card	P-1017879

Number / Description	Art. No.
1 Laser Diode Driver and Temperature Controller	P-1008632
1 Diode Laser 1000 mW	P-1009497
1 Nd:YAG Module	P-1008635
1 Alignment Laser Diode	P-1008634
1 Laser Mirror	P-1008638
1 PIN Photodiode DET 36 A/M	P-1008640
1 Filter RG850	P-1008648
1 Optical Bench KL	P-1008642
1 Transport Case KL	P-1008651
1 Laser Safety Goggles for Nd:YAG Laser	P-1002866
1 Infra-Red Detector Card	P-1017879
1 Digital Multimeter P3340	P-1002785
1 Digital Oscilloscope 4x70 MHz	P-1008676
1 HF Patch Cord, BNC/4 mm Plug	P-1002748
1 HF Patch Cord	P-1002746

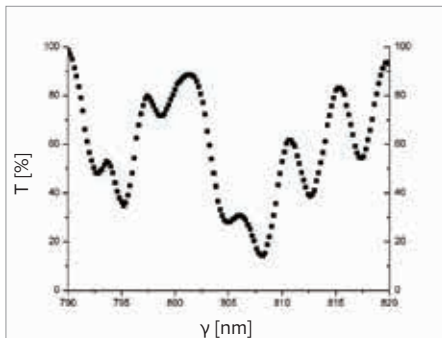

Transmission spectrum of an Nd:YAG crystal as a function of wavelength, recorded using a spectrometer

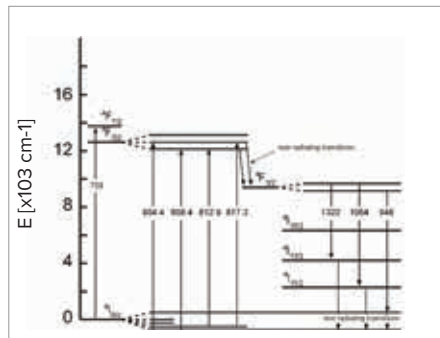

Energy level diagram for an Nd:YAG crystal with the most important transitions for optical pumping and laser operation

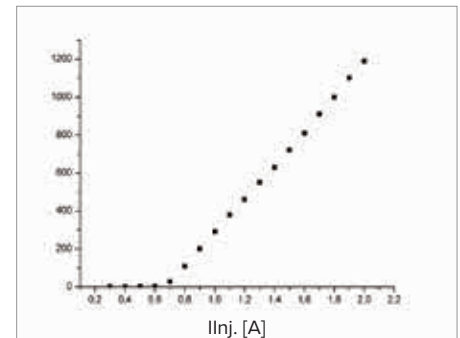

Output power of diode laser at 20° C as a function of the injection current

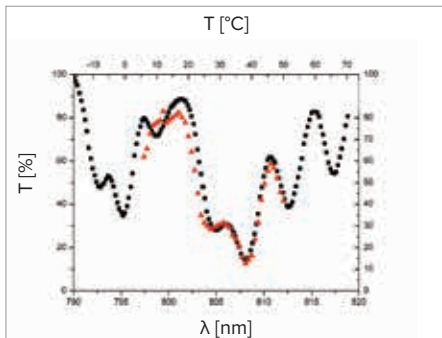

Comparison of transmission functions: Square- $T(\lambda)$ recorded using a spectrometer
Triangular - Transmission as a function of temperature

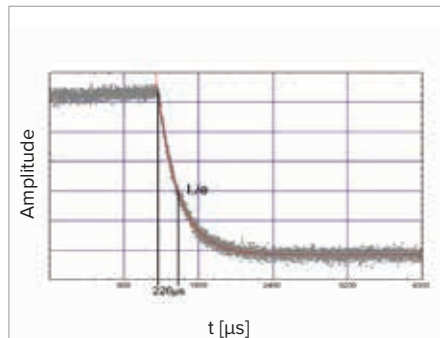

Measurement of half-life for the ${}^4F_{3/2}$ level in an Nd:YAG crystal.
An exponential function has been fitted to the measurements

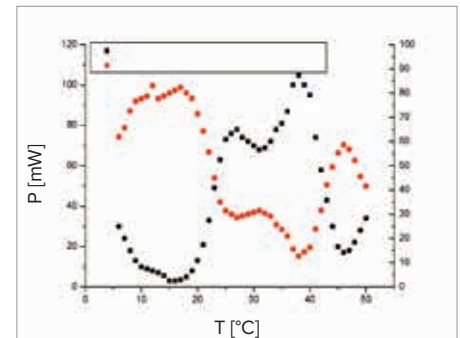

Transmission of light from a diode through an Nd:YAG crystal as a function of temperature for various injection currents

Experiment: "Q-Switch Circuit for Nd:YAG Laser with Cr:YAG Module"

- Set-up and optimisation of Q-switch circuit
- Recording of pulses and determination of pulse duration.

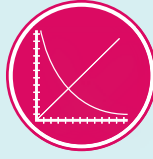

UE4070320
PDF online

Experiment: "Frequency Doubling with an Nd:YAG Laser"

- Frequency doubling within the resonator using a KTP crystal
- Measurement of output power of frequency-doubled beam as a function of power of fundamental wave.
- Investigation of dependency on crystal orientation and temperature.

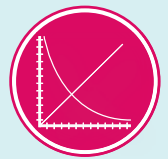

UE4070330
PDF online

Number / Description	Art. No.
1 Laser Diode Driver and Temperature Controller	P-1008632
1 Diode Laser 1000 mW	P-1009497
1 Nd:YAG Module	P-1008635
1 Alignment Laser Diode	P-1008634
1 Cr:YAG Module	P-1008637
1 Laser Mirror	P-1008638
1 PIN-Fotodiode DET 10 A/M	P-1008641
1 Filter RG850	P-1008648
1 Optical Bench KL	P-1008642
1 Transport Case KL	P-1008651
1 Laser Safety Goggles for Nd:YAG Laser	P-1002866
1 Infra-Red Detector Card	P-1017879
1 Digital Multimeter P3340	P-1002785
1 Digital Oscilloscope 4x70 MHz	P-1008676
1 HF Patch Cord, BNC/4 mm Plug	P-1002748
1 HF Patch Cord	P-1002746

Number / Description	Art. No.
1 Laser Diode Driver and Temperature Controller	P-1008632
1 Diode Laser 1000 mW	P-1009497
1 Nd:YAG Module	P-1008635
1 Alignment Laser Diode	P-1008634
1 Frequency Doubling Module	P-1008636
1 Laser Mirror HAT, 532 nm	P-1008639
1 PIN Photodiode DET 36 A/M	P-1008640
1 Filter BG40	P-1017874
1 Filter RG850	P-1008648
1 Optical Bench KL	P-1008642
1 Transport Case KL	P-1008651
1 Laser Safety Goggles for Nd:YAG Laser	P-1002866
1 Infra-Red Detector Card	P-1017879
1 Digital Multimeter P3340	P-1002785
1 HF Patch Cord, BNC/4 mm Plug	P-1002748

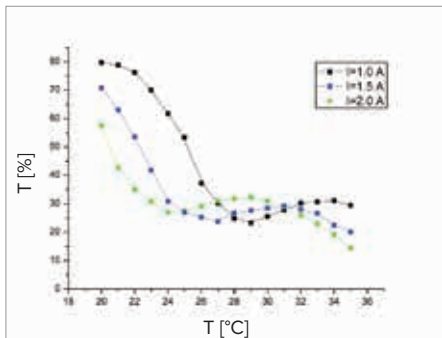

Comparison of curve characteristics for transmission of light through an Nd:YAG crystal and output power of the Nd:YAG laser as a function of the diode temperature

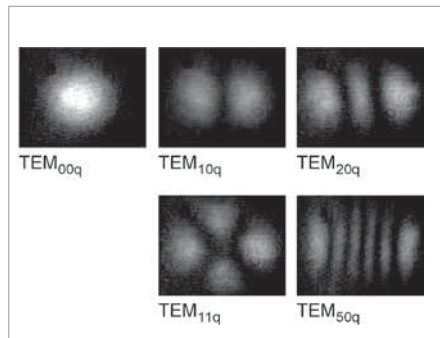

Transverse modes

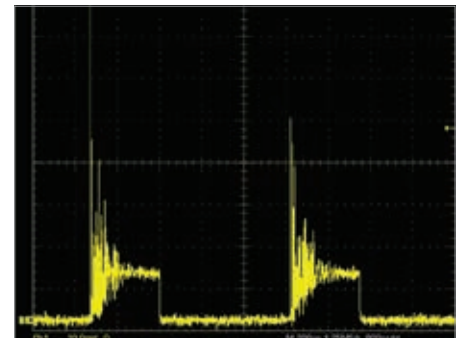

Oscilloscope trace: spiking in a Nd:YAG laser

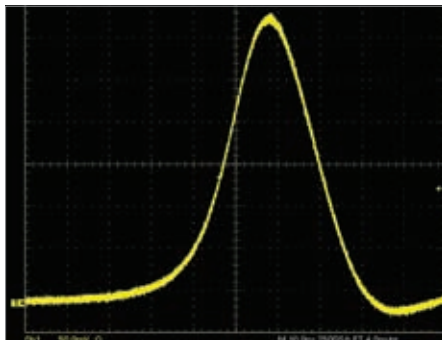

Oscilloscope trace: trace of pulses from a passive Q-switched Nd:YAG laser. Pulse duration 25 ns

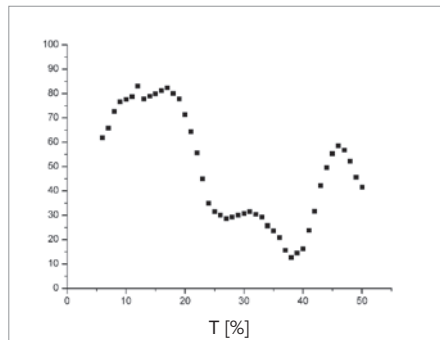

Transmission of light from a diode through an Nd:YAG crystal as a function of temperature at an injection current of 1.5 A

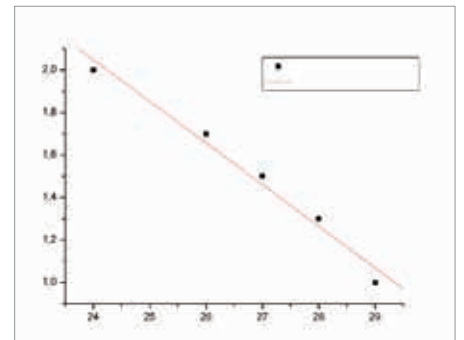

Current-temperature graph at constant wavelength

Experiment Topics:

- Glass fibres and optical telecommunications
- Acceptance cone and optimisation of coupling to a fibre optic cable
- Absorption, effect of the length of the transmission line
- Coupling losses
- Diffraction by an optical grating and optical multiplexing.
- Dichroitic filters and optical demultiplexing
- Spectral composition of light sources
- Spectral dispersion and recomposition
- Colour and interference filters
- Signal shaping and matching
- Band width and limiting frequency
- Calculation of theoretical band width
- Optical diaphony

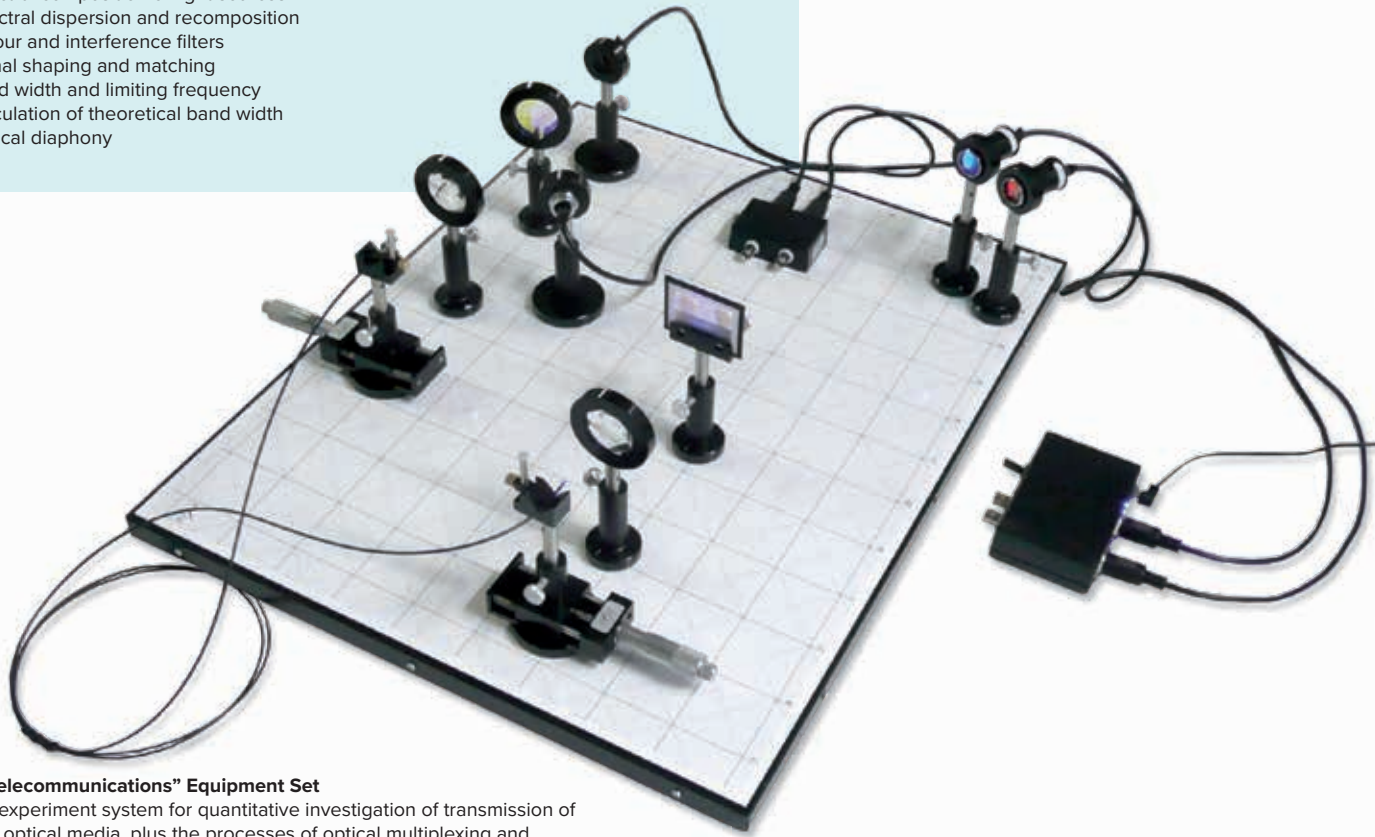

“Optical Telecommunications” Equipment Set

Complete experiment system for quantitative investigation of transmission of signals via optical media, plus the processes of optical multiplexing and demultiplexing. To build a two-dimensional optical system of high precision, a magnetic bench with a printed grid is provided, upon which it is possible to write.

Optical bench:

Available surface:	600x480 mm ²
Grid radials:	0°, 45°, 90°, 135°
Grid subdivisions:	5 cm, 1 cm
Weight:	approx. 12 kg

Contents:

- 1 Optical bench, 600x480 mm, for attachment of magnetic components
- 8 Optical riders with magnetic base
- 2 Movable riders, l = 25 mm, with magnetic base
- 1 LED with collimating lens, in frame on stem, red
- 1 LED with collimating lens, in frame on stem, blue
- 1 Electronic signal transmitter, including power supply
- 1 Electronic signal receiver, including power supply
- 2 Phototransistors in housing on stem
- 1 Fibre-optic cable with SMA plugs, 1 m
- 1 Diffraction grating, 600 lines/mm
- 1 Dichroitic filter in housing on stem, blue
- 1 Dichroitic filter in housing on stem, yellow
- 2 Converging lenses in housing on stem, f = 50 mm, 40 mm diam.
- 1 Slide holder for gratings, on stem
- Component holders and spring clips

P-1008674

Additionally recommended:

- P-1008675** “Spectrometry” Supplementary Set
- P-1020913** Two-Channel Function Generator, 20 MHz
- P-1008676** Digital Oscilloscope 4x70 MHz
- P-1002746** HF Patch Cord (6x)
- P-1002752** T-Piece, BNC (2x)

“Spectrometry” Supplementary Set (not shown)

Supplement to the “Optical telecommunications” equipment set for investigating spectrometry of transmitted signals and measurement of absorption losses.

Contents:

- 1 Spectrometer with SMA connectors
- 1 Reference light source with SMA connectors
- 5 Fibre optic cables with SMA plugs, 2 m
- 1 Fibre optic cable with SMA plugs, 10 m
- 5 SMA/SMA connectors

P-1008675

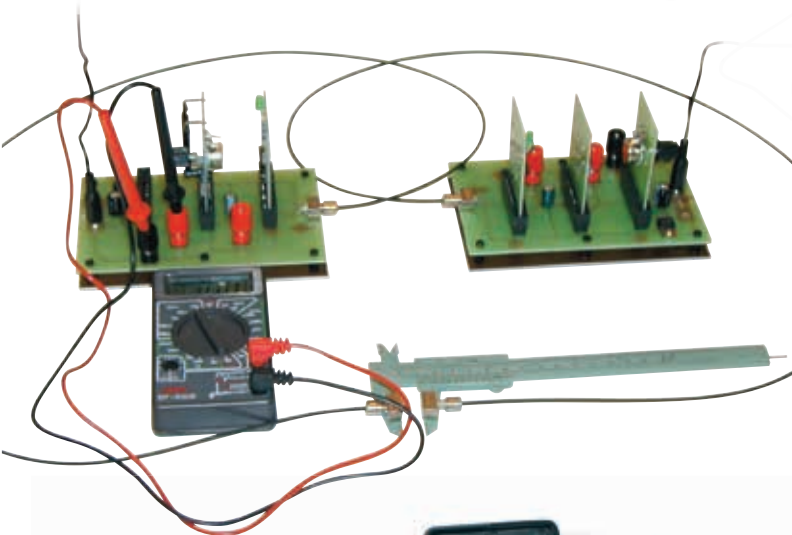

Experiment Topics:

- Tyndall's light guide experiment
- Attenuation in curved optical waveguides
- Attenuation in liquids
- Attenuation at optical transitions
- Setup for force measurement
- Setup of light barrier
- Setup for proximity sensor
- Transmission of audio signals
- Data transmission between two computers

Equipment Set for Waveguide Optics

Complete modular experiment set for examining optical waveguide phenomena and their applications. Consisting of one base PCB for use as a transmitting and receiving module, one analogue transmitting and receiving unit, one digital transmitting and receiving unit, one microphone amplifier and low-frequency generator, one low-frequency amplifier with integrated loudspeaker, USB interface for transmitter and receiver, one digital multimeter, sheathed and unsheathed optical fibres of different lengths and all connecting cables. Including universal plug-in power supplies and storage case.

Wall power supply units: 100 – 240 V AC (primary)
9 V DC (secondary)

P-1003054

Additionally recommended:

P-1020910 Digital Oscilloscope 2x30 MHz

P-1002748 High-Frequency Patch Cord, BNC / 4-mm Plug



Equipment Set for Laser Communication

Experiment system for transmitting audio and video signals with a laser beam. Consisting of power supply for laser diode with variable output power and with audio and video input for modulation of laser beam, receiver unit with integrated amplifier and connectors (CINCH) for loudspeakers and TV set, microphone and loudspeaker. Audio signals are frequency modulated and video signals amplitude modulated. For transmitting video signals, any PAL or NTSC video camera can be connected (not included in scope of delivery). Including universal plug-in power supplies and storage case.

Laser diode: Laser protection class II
Wavelength: 635 nm
Laser power: 0,2 – 1mW continuously variable
Plug-in power supply: 100 – 240 V AC 50/60 Hz (primary),
12 V DC (secondary)

P-1003055



ELECTRICITY & MAGNETISM

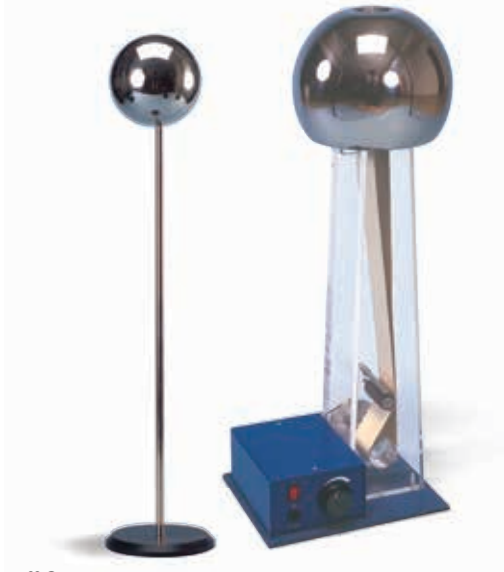

Van de Graaff Generator

Generator for the generation of DC potentials with low current for multiple experiments in electrostatics. Detachable conductor sphere, drive motor with controllable speed, including small discharge sphere on rod.

Voltage: up to approx. 100 kV
 Length of sparks: up to 5 cm
 Conductor sphere: 190 mm diam.
 Sphere on rod: 460 mm, diam. 90 mm
 Dimensions: approx. 240x190x620 mm³

Van de Graaff Generator (230 V, 50/60 Hz) P-1002964

Van de Graaff Generator (115 V, 50/60 Hz) P-1002963

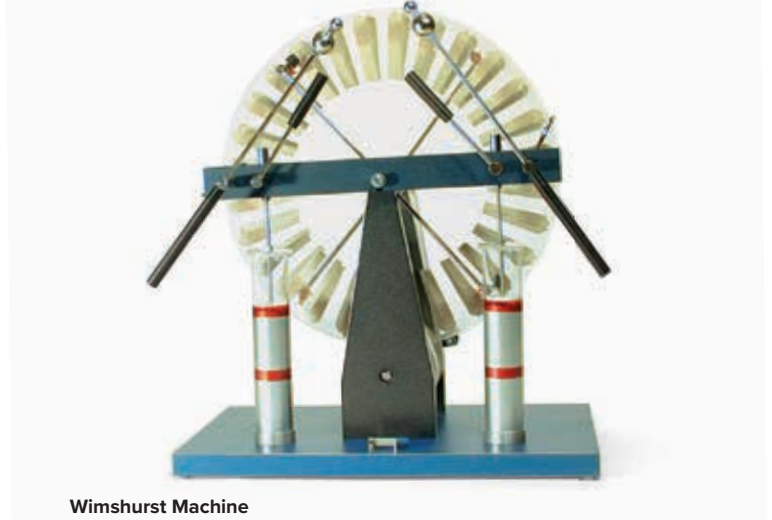

Wimshurst Machine

Historical experiment set-up for the generation of safe, high DC potentials for numerous experiments in the area of electrostatics. Hand crank operation and belt drive, adjustable spark gap, two high-voltage capacitors (Leyden jars).

Diameter: 310 mm
 Spark gap: max. 120 mm
 Dimensions: approx. 360x250x400 mm³
 Weight: approx. 3.4 kg

P-1002967

Rubber Belt for Van de Graaff Generator (not shown)

Spare rubber belt for Van de Graaff generator (P-1002964 or P-1002963).

Length: 930 mm
 Width: 50 mm

P-1002965

Electrostatic Equipment Set

Using this equipment many historical experiments can be performed to investigate electrostatic phenomena. The components are equipped with 4 mm connector pins thus providing for rapid and easy interchangeability of assembly on an insulated stand. Experiment cables are included for connection to the charge source. We recommend that the Wimshurst machine (P-1002967) be used as a charge source in these experiments.

Contents:

- 1 Standbase
- 1 Stand rod, insulated, with retaining and connection socket
- 1 Conductor sphere 30 mm diam., with pin
- 1 Rolling sphere race
- 1 Double pendulum
- 8 Polystyrene balls
- 1 Box with spherical electrode
- 1 Box with pointed electrode
- 1 Triskelion wheel on needle bearing
- 1 Bundle of plastic strips on rod
- 1 Luminous pane
- 1 Chimes with bells
- 1 Friction rod, plastic, with 4 mm socket
- 2 Experiment cables
- Incense cones
- Experiment instructions

P-1021369

Additionally required:

P-1002967 Wimshurst Machine

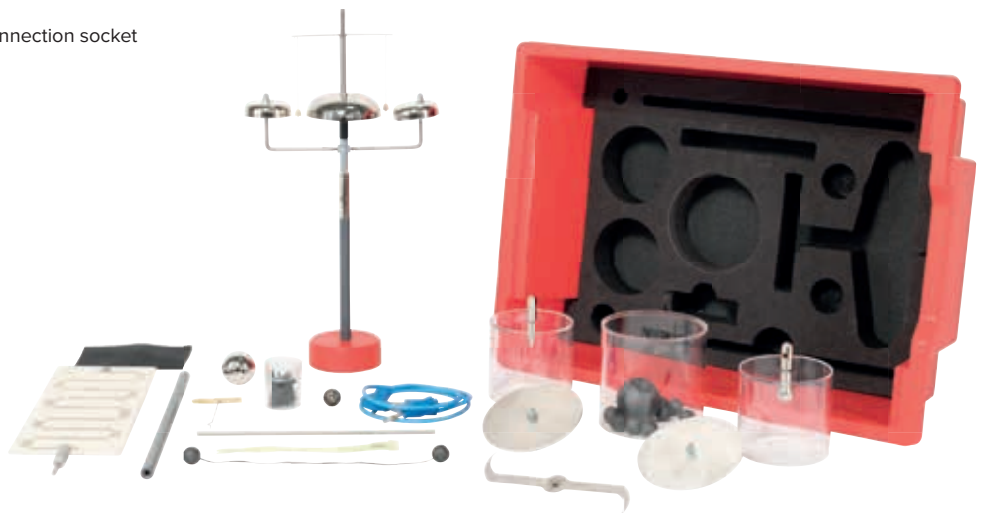



Kolbe's Electroscop

Pointer instrument for the detection of electrical charges and voltages with high sensitivity. Metal housing with 4 mm earthing sleeve, glass front and rear, needle with pivot bearing, scale, suitable for shadow projection. Includes capacitor plate on 4 mm plug.

Measuring range: 0 – 6 kV

Dimensions: approx. 170x110x190 mm³

P-1001027



Electroscop

Pointer instrument for the detection of electrical charges and voltages. Shielding ring with 4 mm earthing sleeve. Suitable for shadow projection. Includes sphere, capacitor plate on 4 mm plug and capacitor plate on insulating rod.

Diameter: approx. 130 mm

P-1003048



Electroscop S

Inexpensive instrument with dial for demonstrating electrical charge and voltage potential. Designed in the form of a stand base, frame, aluminium rod with magnet holder and electroscop unit.

Dimensions: approx. 280x80x280 mm³

Weight: approx. 500 g

P-1009964



Charge Indicator (Electroscop)

Electronic electroscop for showing electric charge and its sign, whereby either a blue or a red LED lights up in the presence of charge. Includes two 1.5-V batteries (AA).

Dimensions: approx. 62x67x20 mm³

Weight: approx. 85 g

P-1009962



Piezoelectric Charge Source

Hand-held unit used for the simple generation of safe voltages needed in electrostatic experiments. Featuring the functional principle of a piezoelectric gas lighter. With shortened earthing sleeve and 4 mm cable plug. The colour may deviate from the colour in the image.

Voltage: ±4.5 kV

Dimensions: approx. 250x25x33 mm³

Weight: approx. 130 g

P-1000923



Charge Storage Device with Piezo Charger

Storage device for electric charge generated by a piezo charger. The stored charge can be transferred from place to place using a so-called "charge-spoon", for example.

Capacitance: 2x 1 nF

Dimensions of storage device: approx. 62x67x50 mm³

Dimensions of charger: approx. 230x35x40 mm³

Total weight: approx. 85 g

P-1009963

Additionally recommended:

P-1002707 Charge Spoon, Small



Electrometer Accessories

Set of accessories for carrying out basic experiments on electrostatics, electricity and the photoelectric effect in combination with an electrometer (P-1001025 or P-1001024) and 450 V DC power supply (P-1008535 or P-1008534).

Contents:

- 1 Faraday cup
- 1 Pair of friction rods
- 1 Metal rod with 4 mm drilled hole
- 1 Safety adaptor socket
- 1 plug-in capacitor 1 nF
- 1 plug-in capacitor 10 nF
- 1 plug-in resistor 100 M Ω
- 1 plug-in resistor 1 G Ω
- 1 plug-in resistor 10 G Ω
- 1 Zinc electrode
- 1 Grid electrode

P-1006813

Conducting Spheres with 4 mm Plugs

Conducting spheres for electrostatics experiments, e.g. for determining the capacity of a sphere or for experiments on the influence of nearby objects.

Conducting Sphere,
diam. = 85 mm, with 4 mm Plug
P-1000938

Conducting Sphere,
diam. = 30 mm, with 4 mm Plug
P-1001026



Additionally recommended:
P-1002710 Drilled Rod

Faraday Cup

Faraday pail with 4 mm plug, e.g. for mounting on an electrostatics (P-1003048 or P-1001027) or electrometer amplifier (P-1001025 or P-1001024).

Dimensions: approx. 115 mm x 70 mm diam.

P-1000972

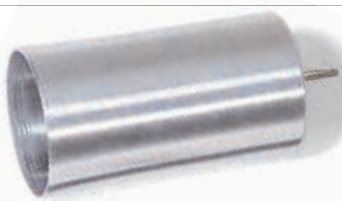

Friction Rods

Two rods for experiments on frictional electricity, made of PVC and acrylic.

Length: approx. 250 mm

Diameter: approx. 10 mm

P-1002709

Charge Spoon

Metal plate on insulating rod for charge transport and for experiments on electrostatic induction.

Art. No.	Designation	Length	Plate	Rod
P-1002707	Charge Spoon, small	205 mm	40x35 mm ²	10 mm diam.
P-1002708	Charge Spoon, large	265 mm	40x70 mm ²	10 mm diam.

Experiment Topics:

- Measurement of charge and voltage in electrostatics
- Measurement of charge and voltage for a plate capacitor
- Ionisation of air by burning gases or α radiation
- Hallwachs effect (external photoelectric effect)



Electrometer

Impedance converter with high-resistance input for measuring extremely small charges and currents. The input signal is converted into a proportional voltage, which can then be measured with an external voltmeter. During the measurement the potentials of the electrometer and the experimenter must be matched by using a metal rod connected to earth. Includes a 12 V AC plug-in power supply.

Electrometer gain factor:	1.00
Input resistance:	>10 ¹² Ω
Output resistance:	<1 k Ω
Input current:	<10 pA
Input capacitance:	<50 pF
Max. output voltage:	\pm 10 V
Resistance to excess voltage:	1 kV (from low-resistance sources) 10 kV (from high-resistance sources)
Supply voltage:	12 V AC
Dimensions:	approx. 110x170x30 mm ³
Weight:	approx. 1 kg

Electrometer (230 V, 50/60 Hz)
P-1001025

Electrometer (115 V, 50/60 Hz)
P-1001024

Additionally recommended:
P-1006813 Electrometer Accessories
P-1013526 Analogue Multimeter Escola 30

P-1008535 DC Power Supply 450 V (230 V, 50/60 Hz)
or

P-1008534 DC Power Supply 450 V (115 V, 50/60 Hz)

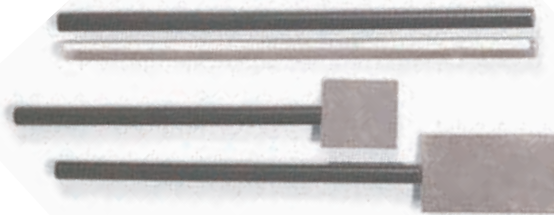

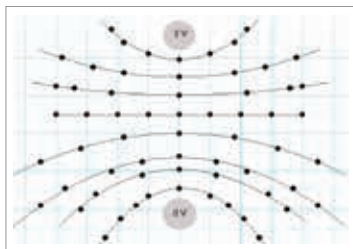

Equipotential lines of point charges

Electrolytic Trough

Equipment set for recording equipotential lines of electric fields. Electrodes of different shapes can be used to measure equipotential lines for a plate capacitor, dipole, induced surface charge and a Faraday beaker.
Trough dimensions: approx. 160x105x65 mm³

Contents:

- 1 Plastic trough
- 1 Stand with measurement electrode
- 2 Bar electrodes
- 2 Round disc electrodes
- 1 Ring electrode
- 20 Sheets of millimetre-grid paper

P-1009884

Additionally required:

- P-1013526** Analogue Multimeter Escola 30
 - P-1008535** DC Power Supply, 450 V (230 V, 50/60 Hz)
- or
- P-1008534** DC Power Supply, 450 V (115 V, 50/60 Hz)



DIN-B Burette with Schellbach Stripe, 10 ml

Burette tube for measuring small amounts of liquid with Schellbach stripe and tap at the side with standard ground (NS) glass connector and cock plug.

- Volume: 10 ml
- Scale divisions: 0.02 ml
- Error limits: Class B

P-1018065

Required Apparatus for Experiment UE3020100:

Number / Description	Art. No.
1 Electrometer (230 V, 50/60 Hz) or	P-1001025
Electrometer (115 V, 50/60 Hz)	P-1001024
1 Electrometer Accessories	P-1006813
1 Analogue Multimeter Escola 30	P-1013526
1 Burette, 10 ml	P-1018065
1 Constantan Wire 0.2 mm / 100 m	P-1000955
1 DC Power Supply 450 V (230 V, 50/60 Hz) or	P-1008535
DC Power Supply 450 V (115 V, 50/60 Hz)	P-1008534
1 Digital Multimeter P3340	P-1002785
1 Digital Stopwatch	P-1002811
1 Tripod Stand 150 mm	P-1002835
1 Stainless Steel Rod 1000 mm	P-1002936
2 Universal Clamp	P-1002830
1 Universal Jaw Clamp	P-1002833
1 Set of 10 Crocodile Clips 4 mm, Not Insulated	P-1019219
1 Set of 3 Safety Experiment Leads for Free Fall Apparatus	P-1002848
2 Pair of Safety Experimental Leads, 75 cm, red/blue	P-1017718
1 Peleus ball, standard	P-1013392
1 Set of 10 Beakers, Low Form	P-1002872

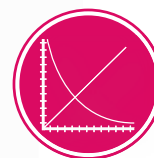
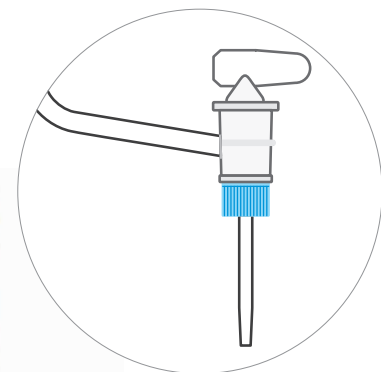

UE3020100

PDF online

Determining the current generated by the movement of the charged water droplets

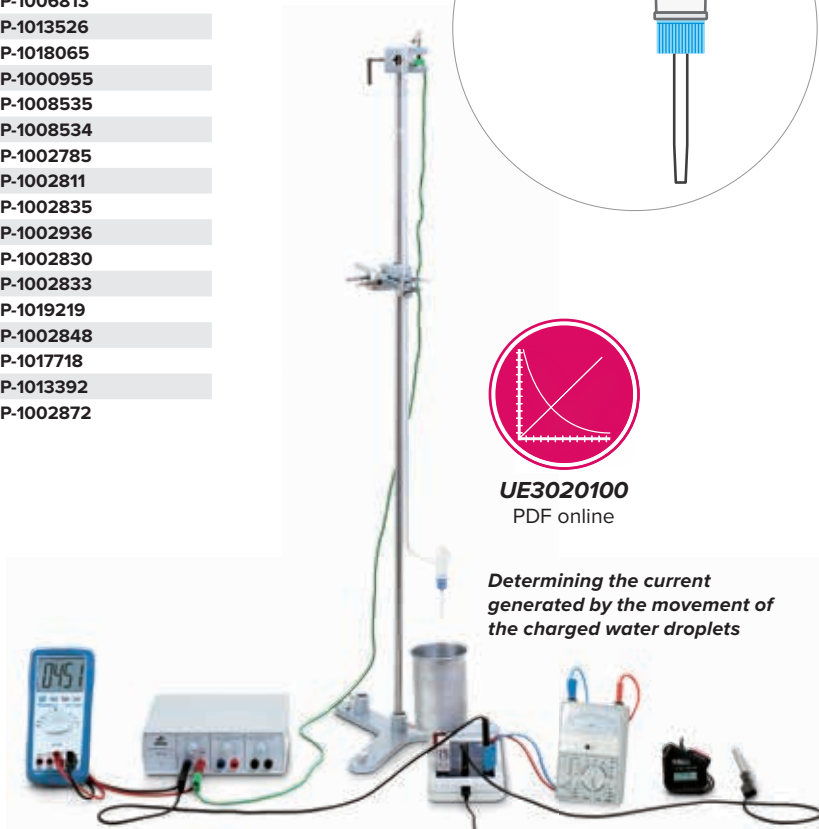

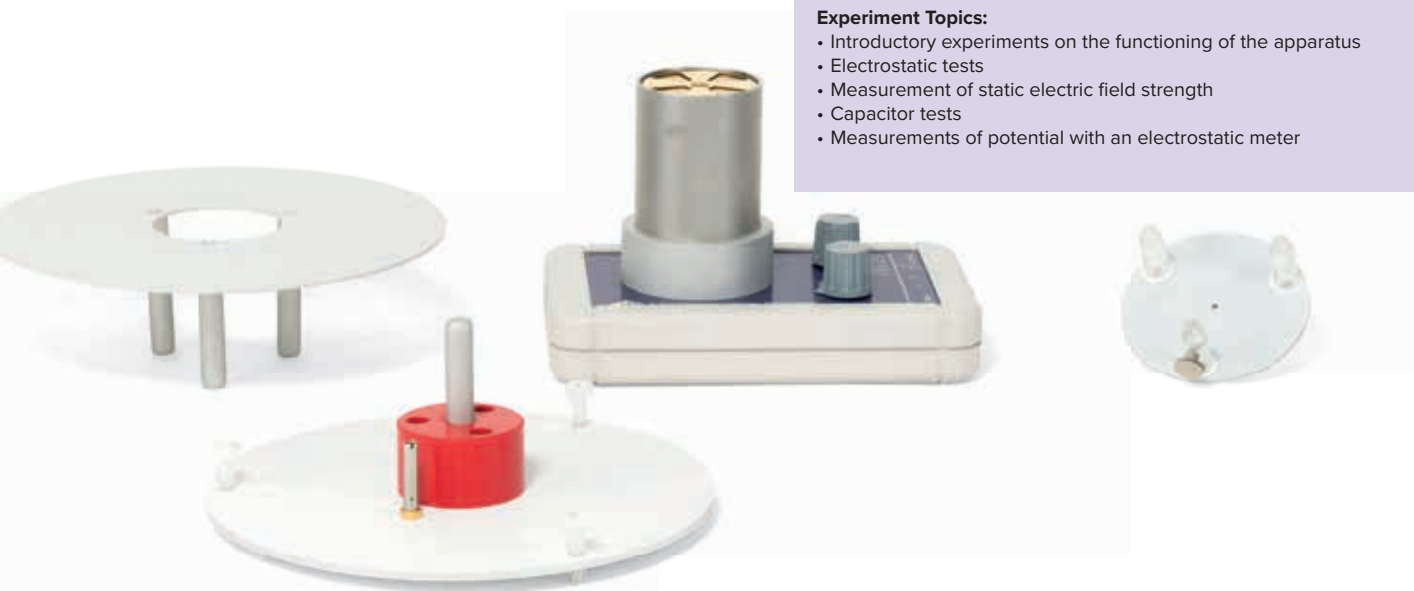

Experiment Topics:

- Introductory experiments on the functioning of the apparatus
- Electrostatic tests
- Measurement of static electric field strength
- Capacitor tests
- Measurements of potential with an electrostatic meter

Electric Field Meter

A device for static measurement of electric field strength and voltages. Mounted at a short distance in front of a star-shaped measuring electrode is a modulation impeller, of the same star shape, and connected to ground. The charges influenced by the electric field produce an alternating current proportional to the field strength. This current is transformed via a synchronous rectifier and a low-pass filter into a bipolar direct current, without any energy being removed from the electric field on average over time. The device can be used as a static voltmeter in conjunction with the voltage measuring plate or 250 cm² plate capacitor. The device is protected against overvoltage. A standard DC voltmeter can be used as a display instrument. The built-in FireWire jack allows connection of the VinciLab data logger (P-1021477) or €Lab (P-1021478).

Max. output voltage: ±6 V
 Measurement ranges: 1 V output can correspond to:
 1 kV/m, 10 kV/m, 100 kV/m, 1000 kV/m
 Dimensions: approx. 175x105x115 mm³
 Weight: approx. 0.7 kg

Contents:

- 1 Electric field meter
- 1 Voltage measurement plate, measuring range 1x
- 1 capacitor measuring plate, 250 cm², adjustable plate distance of 0 - 15 mm
- 1 plug-in power supply unit, 12V AC, 700 mA

Electric Field Meter (230 V, 50/60 Hz)
P-1021405

Electric Field Meter (115 V, 50/60 Hz)
P-1021406

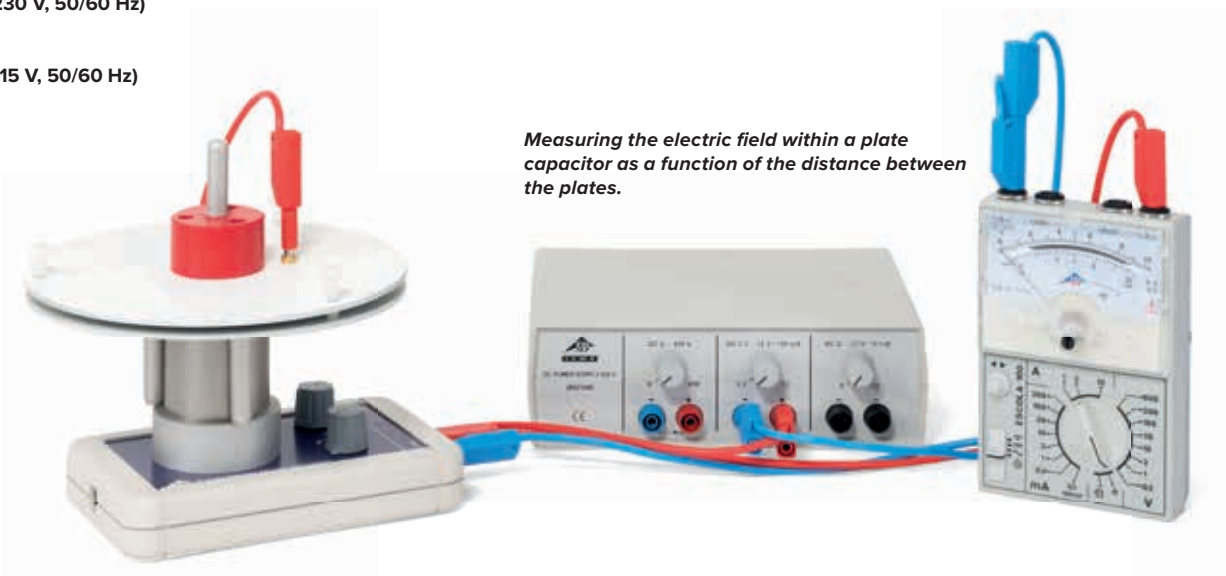

Additionally required:

- P-1013526 Analogue Multimeter Escola 30**
- or
- P-1021682 Voltage Sensor 10 V**
- P-1021514 Sensor Cable**
- P-1021477 VinciLab**
- or
- P-1021478 €Lab**
- Software Coach 7**

Additionally recommended:

- P-1000938 Conducting Sphere, d = 85 mm, with 4 mm Plug**
- P-1001026 Conducting Sphere, d = 30 mm, with 4 mm Plug**
- P-1021799 Flame Probe**
- P-1008535 DC Power Supply 450 V (230 V, 50/60 Hz)**
- or
- P-1008534 DC Power Supply 450 V (115 V, 50/60 Hz)**

Flame Probe for Electric Field Meter

Flame probe for examining electrostatic potential using the E-field meter. Including a clamp mounting with a handle and 4mm connection jack. Delivered without a gas filling.

P-1021799 £167.00

Measuring the electric field within a plate capacitor as a function of the distance between the plates.

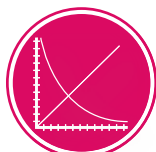

UE3010700
 PDF online

**Advantage**

- Precise determination of plate separation, reading accuracy 1/10 mm

**Plate Capacitor D**

Plate capacitor used to investigate the relationship between electric charge and voltage, quantify capacitance as a function of plate spacing, measure the dielectric constant ϵ and precisely determine the electric field constant ϵ_0 . Plate separation can be finely adjusted and read off from a display to an accuracy of $\frac{1}{10}$ mm.

Plate spacing: 0 – 160 mm

Plates can be adjusted between 0 and 20 mm via a spindle

Plates: Solid castings

Plate area: 500 cm²

Weight: approx. 4.2 kg

P-1006798

Additionally recommended:

P-1000936 Cardboard Plate

P-1000880 Transparent Acrylic Plate

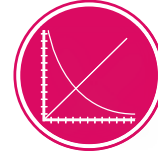
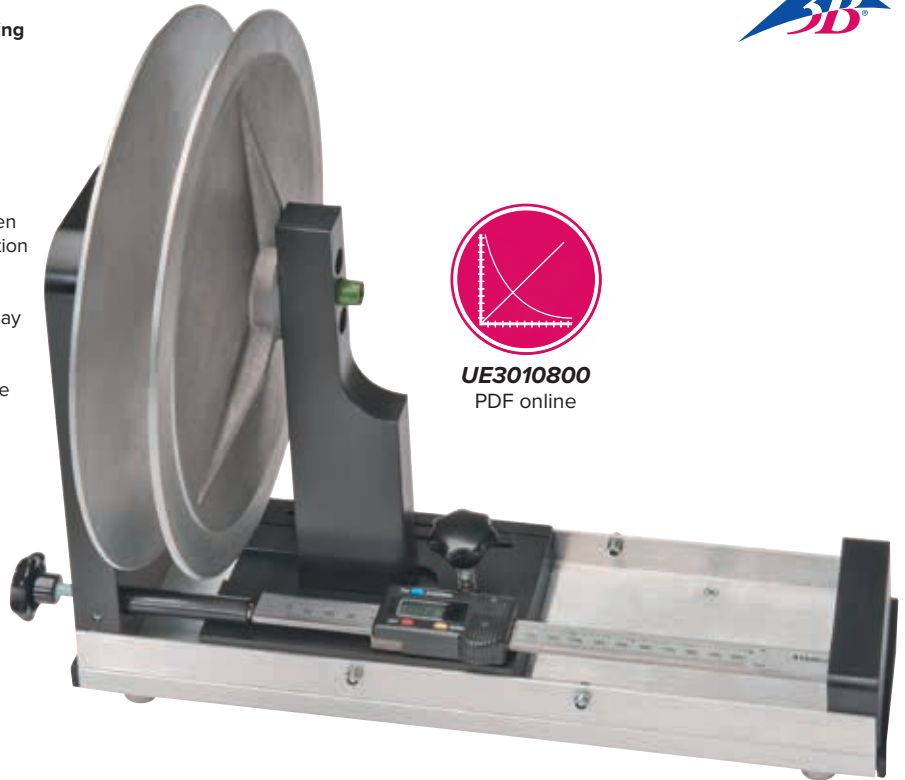

UE3010800

PDF online

**Plate Capacitor S**

Plate capacitor used to investigate the relationship between charge, voltage and capacitance, as well as determining the dielectric and electric field constants. It consists of a fixed and a movable plate on a guide rail. A centimeter scale is used to read the plate spacing. The device comes with four dielectric sample plates made of acrylic, bakelite, plywood and cardboard.

Plate spacing: 0 – 150 mm

Plate diameter: approx. 149 mm

Plate area: 175 cm²

Connection: via 4 mm safety jacks

P-1003232

Dielectric Plates

Dielectric plates for experiments with plate capacitors.

Cardboard Plate

Dimensions: approx. 300x300x2 mm³

Dielectric constant ϵ : approx. 4.5 F/m

P-1000936

Transparent Acrylic Plate

Dimensions: approx. 300x300x2 mm³

Dielectric constant ϵ : approx. 3.4 F/m

P-1000880



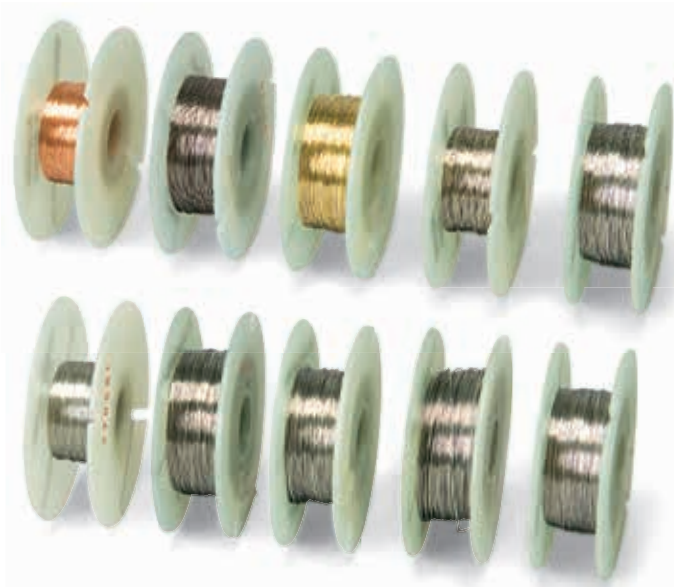

Resistance Wires

Metal wires on bobbins, e.g. for experiments to investigate how resistance depends on the material, cross-sectional area and length of the wire.

Art. No.	Material	Length	Diameter
P-1000949	Copper	100 m	0.3 mm
P-1000950	Iron	100 m	0.3 mm
P-1000959	Brass	50 m	0.3 mm
P-1000951	Nickel	50 m	0.3 mm
P-1000953	Chrome-Nickel	100 m	0.3 mm
P-1000954	Chrome-Nickel	50 m	0.5 mm
P-1000955	Constantan	100 m	0.2 mm
P-1000956	Constantan	100 m	0.3 mm
P-1000957	Constantan	50 m	0.4 mm
P-1000958	Constantan	50 m	0.5 mm

Holder for Components

Holder on an acrylic base with two crocodile clips for connecting loose resistors and other electronic components or samples from the "Conductors and Insulators" set. Sockets for 4 mm safety plugs.

P-1008524



Lamp Socket E10 on Acrylic Base

Lamp socket on transparent acrylic base with screw connection for ordinary commercial filament bulbs for E10 sockets. Sockets for 4 mm safety plugs.

P-1000946



Lamp Socket E14 on Acrylic Base

Lamp socket on transparent acrylic base with screw connection for ordinary commercial filament bulbs for E14 sockets. Sockets for 4 mm safety plugs.

P-1000947

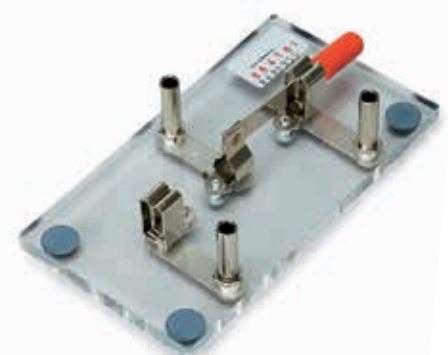

Toggle Switch on Acrylic Base

Switch mounted on a transparent acrylic base for the alternate opening and closing of two electric circuits. Sockets for 4 mm safety plugs.

P-1000960



Momentary Contact Switch on Acrylic Base

Switch mounted on a transparent acrylic base for the momentary closing of circuits. Sockets for 4 mm safety plugs.

P-1000962

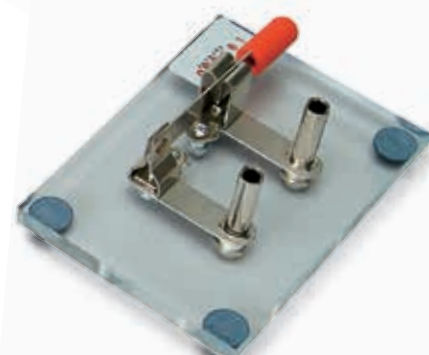

Single-Throw Switch on Acrylic Base

Switch mounted on a transparent acrylic base for the alternate opening and closing of a circuit. Sockets for 4 mm safety plugs.

P-1000961



Set of 10 E10 Lamp Sockets

Set of 10 screw-in sockets for lamps with E10 screw thread. Electrical contact is made via uninsulated wires passing through the connecting eyelets in the base or via crocodile clips.

Base: 28 mm diam.

P-1010137



Set of 10 E10 Bulbs

Set of 10 bulbs with E10 screw-in threads. Lamp design A.

Art. No.	Tension	Current
P-1010142	3.5 V	150 mA
P-1010143	3.5 V	200 mA
P-1010195	3.8 V	300 mA
P-1010196	4 V	40 mA
P-1010197	6 V	50 mA
P-1010144	6 V	100 mA
P-1010145	6 V	350 mA
P-1010140	12 V	100 mA
P-1010141	12 V	500 mA

Set of 10 E10 Bulbs, 6 V, 1 A

Set of 10 6 V, 1 A bulbs with E10 screw-in threads. Lamp design C.

P-1010198

Set of 10 E10 Bulbs, 1.3 V, 60 mA

Set of 10 1.3 V, 60 mA bulbs with E10 screw-in threads. Lamp design B.

P-1010199



Set of "Conductors and Non-Conductors"

Samples of eight materials for experiments to investigate the electrical conductivities of different materials. In a storage container.

Materials: Iron, aluminium, copper, steel, wood, glass,

plastic, cotton

Sample length: approx. 200 mm

Weight: approx. 200 g

P-1000948

Additionally recommended:

P-1008524 Holder for Components



Double-Pole Double Throw Switch

Double-pole double throw (DPDT) change-over switch in a robust casing with high dielectric strength. Connection is made via 4-mm safety sockets.

Dimensions: approx. 112 x 62 x 45 mm

Weight: approx. 95 g

P-1018439



A. Insulator with Clamp

Metal stem with knurled screw and 4 mm bore hole on acrylic rod, as insulated holder for wires, e.g. when conducting experiments on the optical bench are performed.

Diameter: approx. 10 mm

Length: approx. 100 mm

P-1002970

B. Rod Clamp with Insulator

Clamp for the insulated securing of electrical components with 4 mm connectors. A PVC isolator is used to isolate sections from each other. Upper section features two 4 mm cross bore holes and one 6 mm hole with clamping screw. Lower section with two 4 mm cross holes.

Total length: approx. 205 mm

Stem diameter: approx. 10 mm

Weight: approx. 135 g

P-1001054

C. Contact Stand with Terminal Sockets

Connection rod on insulated base with three 4mm cross holes and one axial 4 mm bore hole used to secure components with 4 mm connectors or to plug in 4 mm cables. At the top end spring-loaded terminal socket used as a wire clamp.

Height: approx. 130 mm

Shaft: approx. 105x10 mm²

Base: approx. 25x70 mm²

Weight: approx. 210 g

P-1000995



A

A. LED on 3B Box

LED in an electrically safe box for assembling simple electric circuits using safety experiment leads. Featuring built-in current limiting resistor and printed circuit symbol.

Maximum voltage: 12 V
 Maximum current: 20 mA
 Dimensions: 135x85x40 mm³

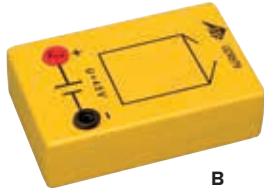

B

**Red LED on 3B Box
 P-1010190**

**Green LED on 3B Box (not shown)
 P-1010191**



C

B. Battery Holder in 3B Box

Battery holder in an electrically safe box for assembling simple electric circuits using safety experiment leads. Printed circuit symbol and battery direction. Batteries not included.

Battery: 4.5 V, 3R12, flat battery
 Dimensions: 135x85x40 mm³



D

P-1010192

F. Crocodile Clips on 3B Box

Pair of crocodile clips for connecting loose resistors and other electronic components or samples from the “Conductors and Non-Conductors” set. Attached to a safe box for building simple electric circuits using safety experiment leads. Printed with a circuit symbol.

Maximum voltage: 12 V
 Maximum current: 2 A
 Dimensions: 135x85x40 mm³

P-1010155

Additionally recommended:

Steel wool

P-1000948 “Conductors and Non-Conductors” Set



E

C. Volta's Pile on 3B Box

Replica of Alessandro Volta's apparatus consisting of series-connected galvanic cells to make up a source of electricity. Zinc and copper plates stacked in alternation on top of each other are separated in each case by a piece of felt soaked in an electrolyte (salt water or acid). The electrolyte makes it possible for electricity to pass between the layers, allowing a voltage to be measured between the plates at the ends.

Connectors: two 4 mm safety sockets
 Electrode diameter: 40 mm
 Case dimensions: 135x85x40 mm³

P-1010132

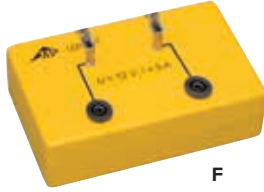

F

G. Diode in 3B Box

1N4002 semiconductor in an electrically safe box for assembling simple electric circuits using safety experiment leads. Featuring printed circuit symbol.

Maximum voltage: 12 V
 Maximum current: 1 mA
 Dimensions: 135x85x40 mm³

P-1010157



G

H. ELV Motor on 3B Box

Low-voltage motor with pulley for simple experiments on mechanical and electrical energy. The relationship between current direction and direction of rotation is immediately obvious. Built onto an electrically safe box for assembling simple electric circuits using safety experiment leads. Printed circuit symbol.

Voltage: 4 – 6 V DC
 Box dimensions: 135x85x40 mm³

P-1010158



H

D. Button on 3B Box

Normally open push-button switch attached to a safe box for building simple electric circuits using safety experiment leads. Printed with a circuit symbol.

Maximum voltage: 12 V
 Maximum current: 2 A
 Dimensions: 135x85x40 mm³

P-1010146



I

E. Knife-Edge Switch on 3B Box

Knife-edge switch attached to a safe box for building simple electric circuits using safety experiment leads. Printed with a circuit symbol.

Maximum voltage: 12 V
 Maximum current: 5 A
 Dimensions: 135x85x40 mm³

P-1010152



J

I. E10 Lamp Socket on 3B Box

E10 lamp socket attached to a safe box for building simple electric circuits using safety experiment leads. Printed with a circuit symbol.

Maximum voltage: 12 V
 Maximum current: 2 A
 Dimensions: 135x85x40 mm³

P-1010138

J. Switch on 3B-Box

Switch attached to a safe box for building simple electric circuits using safety experiment leads. Printed with a circuit symbol.

Maximum voltage: 12 V
 Maximum current: 5 A
 Dimensions: 135x85x40 mm³

P-1010139

K. Coil with 600 Windings on 3B-Box

600-winding coil without core attached to a safe box and featuring safety sockets. For experiments on induction, a bar magnet can be passed through the coil.

Dimensions: 135x85x40 mm³

P-1011346

Additionally recommended:

P-1002726 Zero-Point Galvanometer, CA 403

P-1003112 Bar Magnet

P. Unknown Resistors in 3B Box

Four unknown resistors which can be connected separately in two series circuits. Inside a safe box with sockets for safety experiment leads. Printed with circuit symbols.

Maximum voltage: 6 V

Maximum current: 200 mA

Dimensions: 135x85x40 mm³

P-1012699



K

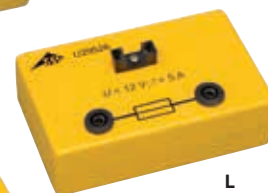

L



M



N

L. Fuse Holder on 3B Box

Fuse holder attached to a safe box for building simple electric circuits using safety experiment leads. Printed with a circuit symbol.

Fuses (not included): 20 mm x 5 mm diam.

Maximum voltage: 12 V

Maximum current: 5 A

Dimensions: 135x85x40 mm³

P-1010154

Q. Graetz Bridge in 3B Box

Bridge rectifier circuit consisting of four semiconductor diodes connected in Graetz configuration. Inside a safe box for building simple electric circuits using safety experiment leads. Printed with circuit symbols.

Maximum voltage: 12 V

Maximum current: 20 mA

Dimensions: 135x85x40 mm³

P-1012695



O

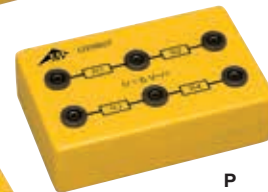

P

M. Change-Over Switch (SPDT) on 3B Box

Single-pole double-throw change-over switch attached to a safe box for building simple electric circuits using safety experiment leads. Printed with a circuit symbol.

Maximum voltage: 12 V

Maximum current: 5 A

Dimensions: 135x85x40 mm³

P-1012694

R. Current Direction Indicator in 3B Box

Circuit comprised of two LEDs for indicating the direction of current. Inside a safe box with sockets for safety experiment leads. Printed with circuit symbols.

Maximum voltage: 12 V

Maximum current: 20 mA

Dimensions: 135x85x40 mm³

P-1012697



Q



R

N. Universal Holder on 3B Box

Universal holder for two-pole components (resistors, capacitors, diodes, LEDs) attached to a safe box for building simple electric circuits using safety experiment leads. Printed with a circuit symbol.

Dimensions: 135x85x40 mm³

P-1010156

S. Ohm's Law Apparatus in 3B Box

Classic set-up for verifying Ohm's law for a two-pole resistor. Inside a safe box with sockets for safety experiment leads. Printed with circuit symbols.

Maximum voltage: 12 V

Maximum current: 2 A

Dimensions: 135x85x40 mm³

P-1012698



S

O. LED Graetz Bridge in 3B Box

Bridge rectifier circuit consisting of four LEDs connected in Graetz configuration. Inside a safe box for building simple electric circuits using safety experiment leads. Printed with circuit symbols.

Maximum voltage: 12 V

Maximum current: 20 mA

Dimensions: 135x85x40 mm³

P-1012696

"Simple Electric Circuit" Experiment

Set consisting of:

1x Battery holder in 3B Box

1x Knife-edge switch on 3B Box

1x E10 lamp socket on 3B Box

1x Set of 10 E10 bulbs

2x Pair of safety experiment leads, 75 cm

P-1013825

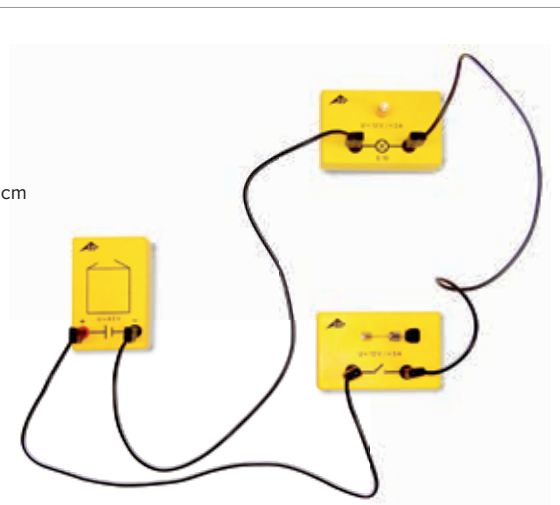

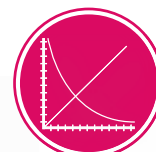

UE3020300
PDF online

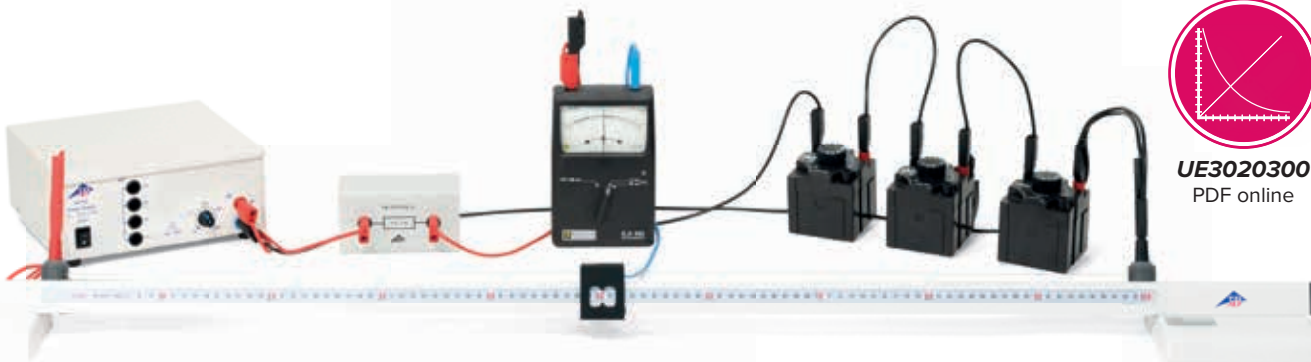

Resistance Bridge

Resistance Bridge used to measure resistances in bridge circuits and investigate voltage drops across wires. The device is only suitable for low voltages. It consists of a rail with a scale mounted at two points and a resistance wire stretched between two connecting sockets. A sliding contact on the resistance wire is used to set the resistance of the resultant two wire sections. A Wheatstone bridge circuit is configured to determine unknown resistances.

Dimensions: approx. 1300x100x90 mm³
 Rail: approx. 30x30 mm²
 Scale: 0 – 1000 mm
 Scale divisions: mm
 Resistance wire: 1 m, 0.5 mm diam.
 Material: NiCr
 Resistance: 5.3 Ω
 Connection: 4 mm safety jacks
 Maximum permissible voltage: 8 V
 Maximum permissible current: 1.5 A

P-1009885

Additionally recommended:

- P-1002726 Zero Galvanometer CA 403
- P-1002730 Resistance Decade 1 Ω
- P-1002731 Resistance Decade 10 Ω
- P-1002732 Resistance Decade 100 Ω
- P-1009843 High-Precision Resistor 1 Ω
- P-1009844 High-Precision Resistor 10 Ω
- P-1021091 AC/DC Power Supply Unit 0 – 12 V, 3 A (230 V, 50/60 Hz)
- or
- P-1021092 AC/DC Power Supply Unit 0 – 12 V, 3 A (115 V, 50/60 Hz)



Resistance Apparatus

Apparatus to investigate the dependency of electrical resistance on conductor length, conductor cross-section and material. Six wires are laid out side by side on a metal base and both ends connect to 4 mm sockets.

Wire specimens: Constantan 1.0 mm diam.,
 Constantan 0.7 mm diam. (2x),
 Constantan 0.5 mm diam.,
 Constantan 0.35 mm diam.,
 Brass 0.5 mm diam.

Wire lengths: 1000 mm
 Dimensions: approx. 1085x120x50 mm³
 Weight: approx. 1.35 kg

P-1009949

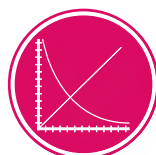

UE3020320
PDF online

Capacitor 2200 μF

Capacitor in plastic housing with 4mm safety plugs.

Capacitance: 2200 μF
 Tolerance: 20%
 Max. permissible voltage: 40 V
 Dimensions: approx. 122x70x50 mm³

P-1000689

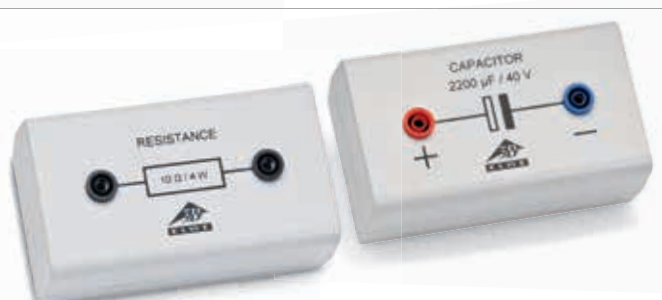

High Precision Resistors

High precision resistors in plastic housing with 4 mm safety plugs.
 Dimensions: approx. 122x70x50 mm³

Art. No.	Resistance	Tolerance	Load rating
P-1009843	1 Ω	1%	4 W
P-1009844	10 Ω	1%	4 W
P-1009886	100 Ω	1%	4 W
P-1009887	1 kΩ	1%	4 W
P-1000685	10 kΩ	1%	4 W
P-1000686	100 kΩ	1%	1 W
P-1000690	300 kΩ	5%	3 W
P-1000687	1 MΩ	1%	1 W
P-1000688	10 MΩ	1%	1 W



Resistance Decade, 1 Ω – 10 k Ω

Four resistance decades in a single housing, can be used individually or in combination, e.g. for setting up a Wheatstone bridge. Can be set using control knob, with decade scale.

Output: via 4 mm safety sockets
 Max. current: 700 mA (1 Ω – 10 Ω),
 200 mA (10 Ω – 100 Ω),
 70 mA (100 Ω – 1 k Ω),
 20 mA (1 k Ω – 10 k Ω)

Accuracy: 1%
 Dimensions: approx. 310x90x80 mm³
 Weight: approx. 1 kg

P-1002735



Rheostats

Slide-contact resistors of high current-bearing capacity in housings that are safe to touch, for experiments with safety low voltage circuits, to be used as continuously variable resistors or voltage dividers. With built-in earth sockets.

Resistance tolerance: 10% from nominal value
 Max. permissible power: 320 W (continuous operation),
 640 W (max. 15min)

Max. permissible voltage: 600 V
 Terminals: 4 mm safety sockets
 Dimensions: approx. 446x93x150 mm³
 Weight: approx. 2.85 kg to 3.25 kg

Art. No.	Resistance	Max. current rating (continuous)	Max. current rating (15 min)
P-1003062	1 Ω	18 A	25 A
P-1003063	3.3 Ω	10 A	12 A
P-1003064	10 Ω	5.7 A	8 A
P-1003065	33 Ω	3.1 A	4.4 A
P-1003066	100 Ω	1.8 A	2.5 A
P-1003067	330 Ω	1 A	1.4 A
P-1003068	1000 Ω	0.57 A	0.8 A
P-1003069	3300 Ω	0.31 A	0.44 A

Capacitance Decades

Capacitance decades which can be mechanically connected to one another. With colour-coded safety sockets and control knob for setting capacitances in 10 steps. Includes 25 cm safety patch cord.

Nominal voltage: 350 V DC
 Connections: 4 mm safety sockets
 Dimensions: approx.

72x72x90 mm³
 Weight: approx. 220 g



Art. No.	Measurement range	Step size	Accuracy
P-1002736	0.01 μ F – 0.1 μ F	0.01 μ F	2%
P-1002737	0.1 μ F – 1 μ F	0.1 μ F	2%

Resistance Decades

Resistance decades which can be mechanically connected to one another, e.g. in order to assemble a Wheatstone bridge. With colour-coded safety sockets and control knob for setting measurement resistances in 10 steps. Includes 25 cm safety patch cord.

Connections: 4 mm safety sockets
 Dimensions: approx. 72x72x90 mm³
 Weight: approx. 220 g

Art. No.	Measurement range	Step size	Max. current	Accuracy
P-1002730	0.1 Ω – 1 Ω	0.1 Ω	1 A	1% \pm 5 m Ω
P-1002731	1 Ω – 10 Ω	1 Ω	750 mA	1% \pm 5 m Ω
P-1002732	10 Ω – 100 Ω	10 Ω	250 mA	0.5%
P-1002733	100 Ω – 1 k Ω	100 Ω	75 mA	0.5%
P-1002734	1 k Ω – 10 k Ω	1 k Ω	25 mA	0.5%



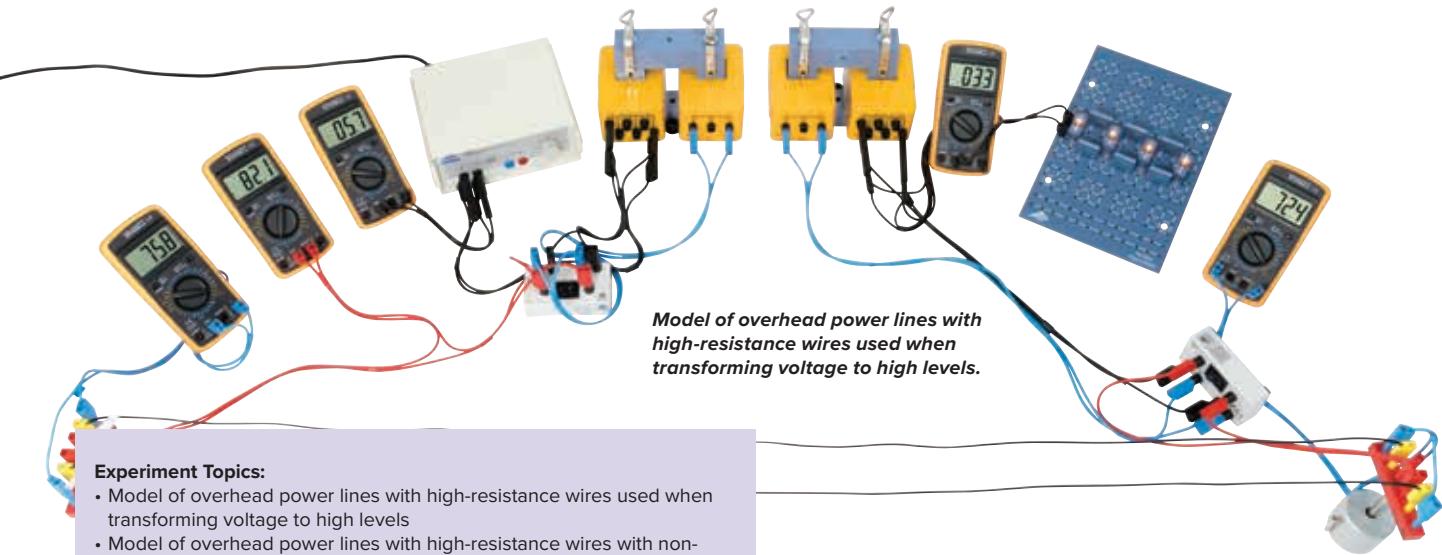

Model of overhead power lines with high-resistance wires used when transforming voltage to high levels.

Experiment Topics:

- Model of overhead power lines with high-resistance wires used when transforming voltage to high levels
- Model of overhead power lines with high-resistance wires with non-transformed voltages
- Use of lower resistance connecting lines for non-transformed voltage

Model of Overhead Power Lines, Pair

The set of two resistor wires of resistance 22Ω and length 1.5 m can be used as connecting wires in experiments involving model overhead power lines or transmission lines for the transmission of electrical energy. In such experiments they guarantee basic protection against contact with live components.

- Connectors: 4 mm safety plugs
- Resistance: 22Ω per wire
- Length of wire: 1.5 m
- Diameter of wire: 0.3 mm
- Wire material: CrNi
- Maximum permitted power: 3 W
- Maximum permitted voltage: 300 V
- Measurement category: CAT I

P-1021347 £26.00

Additionally required:

- Extra-Low Voltage Power Supply e.g.
- P-1003316 Transformer with Rectifier 3/ 6/ 9/ 12 V, 3 A (230 V, 50/60 Hz) or
- P-1003315 Transformer with Rectifier 3/ 6/ 9/ 12 V, 3 A (115 V, 50/60 Hz)
- P-1000976 Transformer Core D (2x)
- P-1000985 Low Voltage Coil D (2x)
- P-1000989 Coil D 400/1200 (2x)
- P-1018832 Digital Multimeter E (5x)
- P-1010138 Lamp Socket E10 on 3B Box (4x)
- P-1010145 Set of 10 Lamps E10, 6 V, 350 mA
- P-1018439 Two-Pole Switch (DPDT) (2x)
- P-1018449 Holder for Plug-in Components (2x)
- P-1002834 Barrel Foot, 1 kg (2x)
- P-1002848 Set of Safety Experiment Leads, 150 cm, 2x75 cm (2x)
- P-1002843 Set of 15 Safety Experiment Leads, 75 cm (2x)

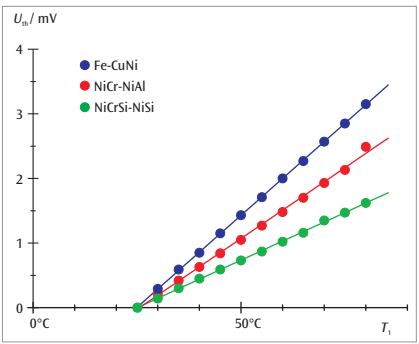

Set of 3 Thermocouples

Set consisting of three different thermocouples for demonstrating the Seebeck effect and measuring thermo-electric voltage as a function of the difference in temperature from a specific reference point. In each case, to create a temperature difference, the contact point of the thermocouple is immersed in a water bath.

- Length of leads: 2 m
- Operating temperature: -75°C to 250°C
- Connection: 4 mm safety plugs
- Sensitivity: 30 μ V/K (NiCrSi-NiSi)
- 43 μ V/K (NiCr-NiAl)
- 54 μ V/K (Fe-CuNi)

Contents:

- 1 Thermocouple type N, NiCrSi-NiSi
- 1 Thermocouple type K, NiCr-NiAl
- 1 Thermocouple type J, Fe-CuNi

P-1017904 £88.00

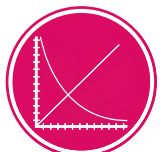

UE6020500
PDF online

Thermocouple voltages as a function of temperature for Fe-CuNi, NiCr-NiAl and NiCrSi-NiSi thermocouples. The measured curves cross the T_1 axis of the graph at the reference temperature $T_2 = 23^\circ\text{C}$

Calibration of NTC thermistor probe

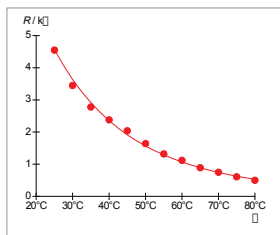

Calibration curve for NTC thermistor probe



NTC Thermistor Probe, 4.7 kΩ

The waterproof 4.7 kΩ NTC thermistor probe is used in experiments to study how the resistance of a negative temperature coefficient semiconducting thermistor depends on temperature. The probe is immersed in a water bath and the current passing through it is measured for known voltage.

Probe: B57891-M472-K
 Resistance at 25°C: 4.7 kΩ (±10%)
 Coefficient B25/100: 3980 K (±3%)
 Maximum temperature: 120°C
 Maximum power: 0.2 W
 Maximum voltage: 30 V DC
 Measurement category: CAT I
 Connectors: 4 mm safety plugs
 Total length: approx. 0.75 m
 Weight: approx. 40 g

P-1021413

Additionally required:

P-1003560 DC Power Supply 1,5 – 15 V, 1,5 A (230 V, 50/60 Hz)

For 100 - 120 V mains voltage additionally:

- P-1003649 Voltage Transformer**
- P-1018832 Digital Multimeter E (2x)**
- P-1017718 Pair of Safety Experiment Leads, 75 cm, Blue, Red**
- P-1002849 Pair of Safety Experiment Leads, 75 cm, Black**
- P-1002879 Rod Thermometer, Graduated**
- P-1002872 Set of 10 Beakers, Low Form**

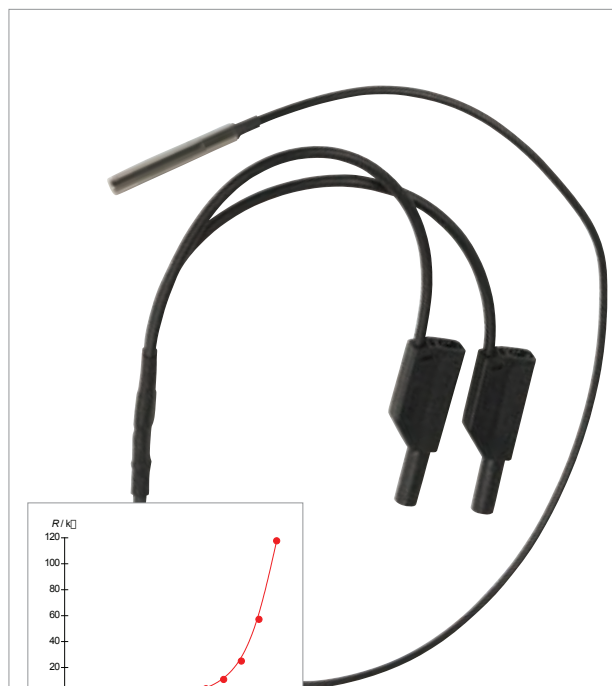

PTC Thermistor Probe, 100 Ω

The waterproof 100 Ω PTC thermistor probe is used in experiments to study how the resistance of a positive temperature coefficient semiconducting thermistor depends on temperature. The probe is immersed in a water bath and the current passing through it is measured for known voltage.

Probe: B59100C050A070
 Resistance at 25°C: 100 Ω (±10%)
 T_{Sensor} : 50°C
 Maximum temperature: 120°C
 Maximum power: 0.2 W
 Maximum voltage: 30 V DC
 Measurement category: CAT I
 Connectors: 4 mm safety plugs
 Total length: approx. 0.75 m
 Weight: approx. 40 g

P-1021435

Additionally required:

P-1003560 DC Power Supply 1,5 – 15 V, 1,5 A (230 V, 50/60 Hz)

For 100 - 120 V mains voltage additionally:

- P-1003649 Voltage Transformer**
- P-1018832 Digital Multimeter E (2x)**
- P-1017718 Pair of Safety Experiment Leads, 75 cm, Blue, Red**
- P-1002849 Pair of Safety Experiment Leads, 75 cm, Black**
- P-1002879 Rod Thermometer, Graduated**
- P-1002872 Set of 10 Beakers, Low Form**

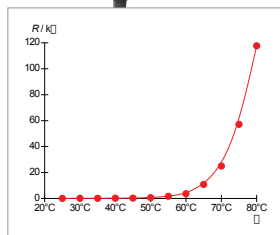

Calibration curve for PTC thermistor probe

Experiment Topics:

- Assembly of a bell circuit
- Assembly of a relay
- Assembly of a bimetallic switch circuit

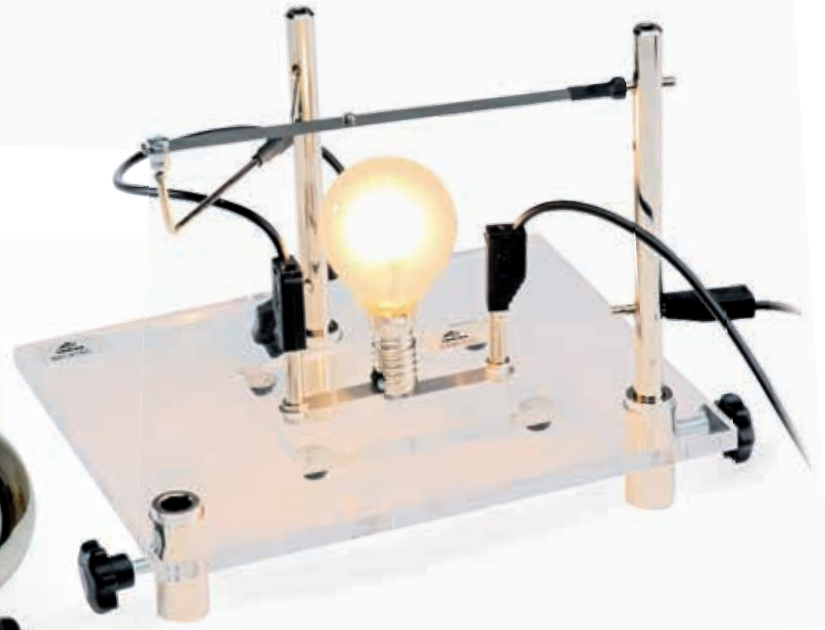
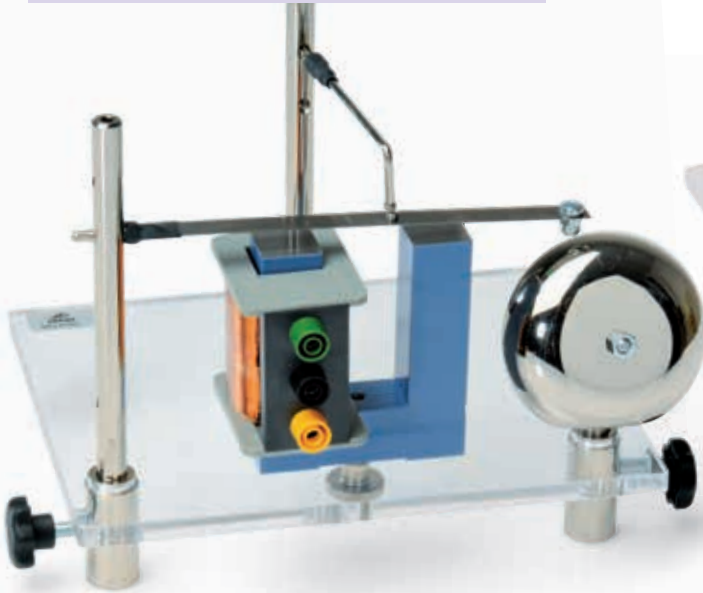

Assembly Kit “Bell, Relay and Bimetallic Switch”

Equipment kit comprising materials to assemble electromagnetic switches and bimetallic switches.

Base plate: approx. 200x140x40 mm³
Weight: approx. 1.6 kg

Contents:

- 1 Stand plate with 3 clamps
- 1 Bell, 70 mm in diameter
- 2 Contact rods with three 4 mm cross holes
- 1 Leaf spring with connector
- 1 Bimetallic strip with connector
- 1 Armature with connector
- 1 Contact pin with connector
- 1 U-core, 20x20 mm²
- 1 Coil, 800 turns

P-1000994

Additionally required:

P-1006858 Bulb E14, 12 V, 25 W

P-1000947 Lamp Socket E14

P-1003316 Transformer with Rectifier (230 V, 50/60 Hz)

or

P-1003315 Transformer with Rectifier (115 V, 50/60 Hz)

Bulb E14, 12 V, 25 W (not shown)

P-1006858

Inductance Decade

Variable inductance decade in impact-resistant plastic housing. This series incorporates mechanically stable components, a slide switch for setting measurement ranges and 4 mm safety sockets to ensure that all connections are safe.

Measuring range: 10 μ H – 111.1 mH
Increment: 10 μ H
Accuracy: 5%
Number of decades: 4
Limiting values: max. 100 mA AC/DC
Dimensions: approx. 140x190x80 mm³
Weight: approx. 450 g

P-1013905

Capacitance Decade

Capacitance decade in impact-resistant plastic housing. This series incorporates mechanically stable components, a slide switch for setting measurement ranges and 4 mm safety sockets to ensure that all connections are safe.

Measuring range: 100 pF – 11.11 μ F
Increment: 100 pF
Accuracy: 5%
Number of decades: 5
Limiting values: max. 50 V DC
Dimensions: approx. 140x190x80 mm³
Weight: approx. 350 g

P-1013906



Experiment Topics:

- Ohm's law
- Parallel resistor circuits
- Series resistor circuits
- Unknown resistance
- Potentiometers
- Voltage dividers with no load
- Voltage dividers with load
- Discharge of a capacitor
- Bridge rectifiers
- Half-wave rectifiers
- Characteristic curve for a lamp
- Characteristic curve for an LED
- Characteristic curve for a silicon diode
- Characteristic curve for a zener diode
- LC parallel resonant circuit
- LC series resonant circuit
- RLC series resonant circuit

Basic Experiment Board

Experiment board with basic circuits for electricity and electronics: circuit components, Ohm's law, Kirchhoff's laws, rheostat and potentiometer circuits, two way switching, charging and discharging curves of a capacitor, inductive effects in DC and AC circuits. Simple semiconductor circuits for determining diode characteristics, rectifier circuits, filter factors. The components can be interconnected via 2 mm sockets using jumpers and experiment leads. Six 2 mm/4 mm safety socket adaptors are provided for connecting 4 mm experiment leads.

- Voltage limitation to 25 V AC and 60 V DC
- Safety transformer conforming to EN 61558-2-6
- Safe isolation between power supply and output circuits

Contents:

- 10 Leads (5 red and 5 blue) with 2 mm plugs, 20 cm long
- 10 Jumpers
- 1 Plug-in power supply 8 V AC/500 mA
- 1 board with the following electronic components:
 - 13 0.5 W resistors ranging from 100 Ω – 100 k Ω
 - 1 Potentiometer, 1 k Ω
 - 3 Filament lamps, 12 V
 - 2 Slide switches
 - 5 Capacitors (2x 2.2 μ F, 1x 100 μ F [bipolar], 1x 1000 μ F)
 - 5 1 A rectifier diodes
 - 1 Zener diode
 - 1 Red light emitting diode
 - 1 Neon fluorescent light
 - 1 Transformer, 12 V
- Dimensions: approx. 233x160 mm²

Basic Experiment Board (230 V, 50/60 Hz)
P-1000573

Basic Experiment Board (115 V, 50/60 Hz)
P-1000572

Additionally recommended:

- P-1013526 Analogue Multimeter Escola 30
- P-1009957 Function Generator FG 100 (230 V, 50/60 Hz)
- or
- P-1009956 Function Generator FG 100 (115 V, 50/60 Hz)
- P-1021477 VinciLab

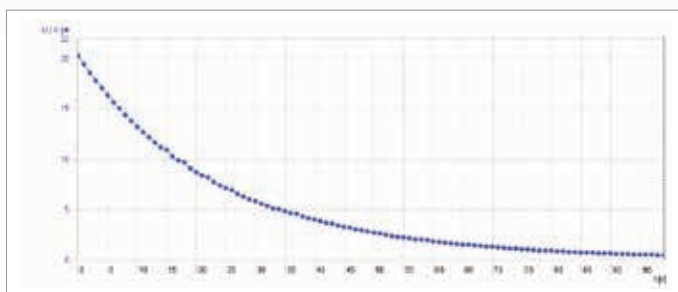
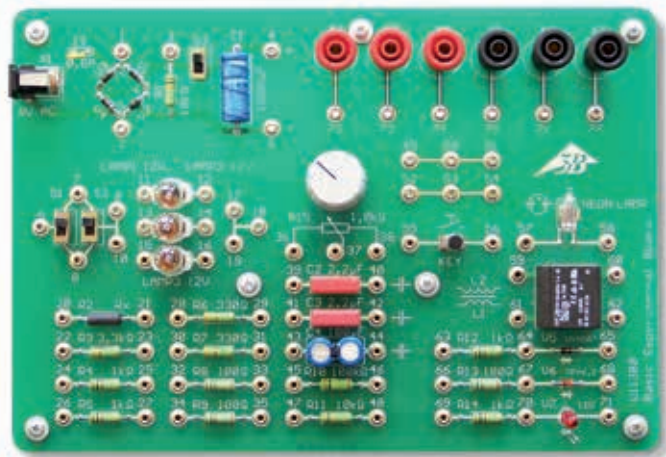

Discharge curve of a capacitor

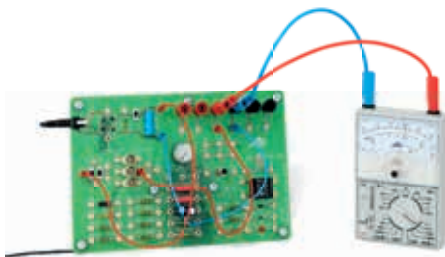

Measurement of the discharge of a capacitor



UE3050400
PDF online



Measurement of a resonance curve for an RLC series resonant circuit



Characteristic curve for a zener diode

► Plug-in Board and Components for Building Electrical and Electronic Circuits in Demonstrations or Students' own Experiments

Plug-in Board for Components

Plug-in board for assembling electrical and electronic circuits using components in plug-in housings. Features 4 mm sockets on the front and rear, each internally connected to a square of 9 sockets plus two continuous serial layouts each with 12 sockets. Two adjacent plug-in boards can be connected together via plug-in components to make a board that is twice as big.

Connector squares: 16 complete squares and four half-squares
 Socket separation: 19 mm from edge to edge of connector squares
 50 mm from centre to centre of connector squares

Dimensions: 300x200x24 mm³

P-1012902

► Pick out the individual components for your circuit yourself. Ask us about bulk discounts, even when ordering a mix of components in large numbers.

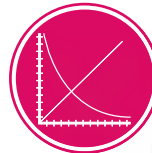

UE3050101
UE3050321
 PDF online

Plug-in board with components to build a power controller

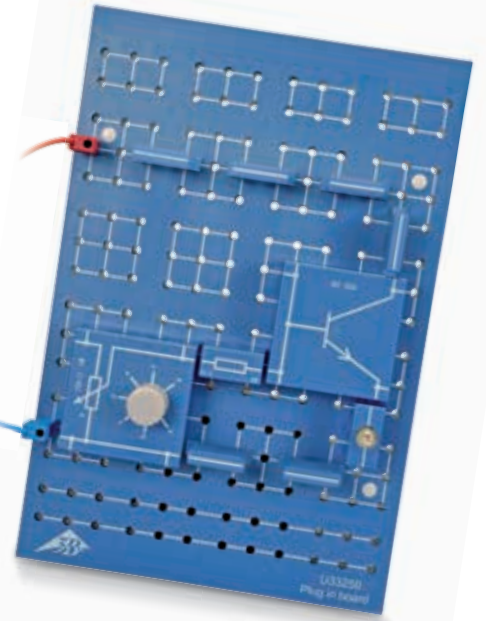

Components in Plug-in Housings with Two Plugs Separated by 19 mm

Capacitors

Art. No.	Capacitance	Tolerance	Max. tension
P-1012947	100 pF	20 %	160 V
P-1012948	470 pF	20 %	160 V
P-1012949	1 nF	20 %	100 V
P-1012950	2.2 nF	20 %	160 V
P-1012951	4.7 nF	2.5 %	100 V
P-1012952	10 nF	20 %	100 V
P-1012943	22 nF	20 %	100 V
P-1012944	47 nF	5 %	100 V
P-1012945	0.22 µF	5 %	250 V
P-1012946	4.7 µF	5 %	63 V
P-1012953	0.1 µF	20 %	100 V
P-1012954	0.47 µF	20 %	100 V
P-1012955	1 µF	20 %	100 V
P-1012956	2.2 µF	5 %	63 V

Linear Resistors

Art. No.	Resistance	Tolerance	Max. power
P-1012903	1 Ω	1 %	2 W
P-1012904	10 Ω	1 %	2 W
P-1012905	10 Ω	5 %	10 W
P-1012906	5.1 Ω	1 %	2 W
P-1012907	22 Ω	1 %	2 W
P-1012908	47 Ω	1 %	2 W
P-1012909	68 Ω	1 %	2 W
P-1012910	100 Ω	1 %	2 W
P-1012911	150 Ω	1 %	2 W
P-1012912	220 Ω	1 %	2 W
P-1012913	330 Ω	1 %	2 W
P-1012914	470 Ω	1 %	2 W
P-1012915	680 Ω	1 %	2 W
P-1012916	1 kΩ	1 %	2 W
P-1012917	1.5 kΩ	1 %	2 W
P-1012918	2.2 kΩ	1 %	2 W
P-1012919	3.3 kΩ	1 %	2 W
P-1012920	4.7 kΩ	1 %	2 W
P-1012921	6.8 kΩ	1 %	2 W
P-1012922	10 kΩ	1 %	0.5 W
P-1012923	15 kΩ	1 %	0.5 W
P-1012924	22 kΩ	1 %	0.5 W
P-1012925	33 kΩ	1 %	0.5 W
P-1012926	47 kΩ	1 %	0.5 W
P-1012927	68 kΩ	1 %	0.5 W
P-1012928	100 kΩ	1 %	0.5 W
P-1012929	220 kΩ	1 %	0.5 W
P-1012930	330 kΩ	1 %	0.5 W
P-1012931	470 kΩ	1 %	0.5 W
P-1012932	1 MΩ	1 %	0.5 W
P-1012933	10 MΩ	1 %	0.5 W



Electrolytic Capacitors

Art. No.	Capacitance	Tolerance	Max. tension
P-1012957	10 µF	20 %	35 V
P-1012958	47 µF	20 %	35 V
P-1012959	100 µF	20 %	35 V
P-1012960	470 µF	20 %	16 V
P-1017806	1000 µF	20 %	35 V



LEDs

Art. No.	Colour	Orientation
P-1012962	red	upward facing
P-1012971	green	upward facing
P-1012972	red	side facing
P-1018837	yellow	upward facing
P-1018839	infrared	side facing

Art. No.	Type	Max. power dissipation
P-1012965	ZPD 3.3	0.5 W
P-1012966	ZPD 9.1	0.5 W
P-1012967	ZPD 6.2	0.5 W
P-1012968	ZPY 5.6	1.3 W
P-1012969	ZPY 8.2	1.3 W
P-1012970	ZPD 18	0.5 W

Semiconductor Diodes

Art. No.	Type	Material	Cut-off voltage	Max. long-term current
P-1012964	1N 4007	Si	1000 V	1 A
P-1012961	BY 255	Si	1300 V	3 A
P-1012963	AA 118	Ge	90 V	50 mA

Thermistors Max. temperature:

Art. No.	Type	Resistance (25°C)	Resistance (100°C)
P-1012941	NTC	2.2 kΩ	120 Ω
P-1012942	PTC	100 Ω	

Phototransistor BPX43

Phototransistor for use as light-sensitive switch.

Range of sensitivity: 450 – 1100 nm

Max. operating voltage: 32 V

Max. current load: 100 mA

Max. Power dissipation: 0.3 W

P-1018842



Voltage Dependent Resistor

Characteristic voltage at 1 mA: approx. 8 V (DC)

P-1018841



Single-Pole Push-Button Switches

Art. No.	Type
P-1012988	Normally open
P-1012989	Normally closed

Coils

Art. No.	Type	Inductance
P-1012983	Coil	10 mH
P-1012984	High-Frequency Coil	33 mH

Single-Pole Rocker Switch

P-1012990

Micromotor 1.5 V DC

Miniature motor with gearbox permanently fixed to the side.

Operating voltage: 0.5 – 1.5 V DC

Gear ratio: 40 : 1

P-1012995



LDR 05 Photoresistor

Resistance: 100 Ω (bright light)
– 10 MΩ (dark)

Max. power dissipation: 0.2 W

P-1012940



Silicon Photovoltaic Cell BPY47P

Range of sensitivity: 420 – 1060 nm

Max. sensitivity: 820 nm

Open-circuit voltage: 0.45 V

Short-circuit current: 1.4 mA

Max. current load: 100 mA

Max. Power dissipation: 0.3 W

P-1018844



Additionally recommended:

Holder for Plug-in Components

P-1018449

BR 100 Diac

BR100 diac in a plug-in housing printed with the appropriate circuit symbol.

Breakdown voltage: approx. 32 V

Breakdown current: approx. 50 μA

P-1012973



Components in Plug-in Housings with Four Plugs Separated by 50 mm



Potentiometers

Art. No.	Resistance	Max. power
P-1012934	220 Ω	1 W
P-1012935	470 Ω	1 W
P-1012936	1 kΩ	1 W
P-1012937	10 kΩ	1 W
P-1012938	4.7 kΩ	1 W
P-1012939	100 kΩ	1 W

Transistors

Art. No.	Type	Current gain	Power dissipation
P-1012974	NPN BD137	40 – 250	5 W
P-1018845	NPN BC140	100 – 250	0.8 W
P-1012976	NPN BC550	420 – 800	0.5 W
P-1012975	PNP BD138	40 – 250	5 W
P-1018846	PNP BC160	100 – 250	3.7 W
P-1012977	PNP BC560	420 – 800	0.5 W
P-1018847	Darlington TIP 162	approx. 200	max. 3 W

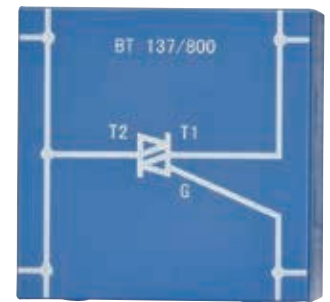
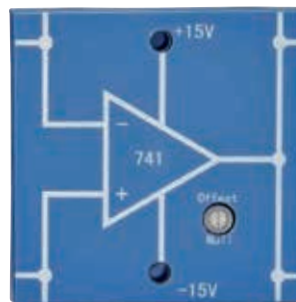
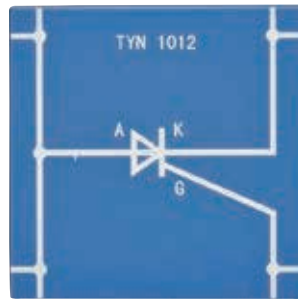

BF 244 Field Effect Transistor
 Type: BF244,
 N-channel-FET
 Power dissipation: 300 mW
P-1012978

TYN 1012 Thyristor
 Type: TYN 1012,
 N-channel FET
 Cut-off current: 8 A
P-1012979

LM 741 Operational Amplifier
 Operating voltage: ±15 V DC
 Output current: 15 mA
P-1012981

BT 137/800 Triac
 Type: BT 137/800
 Cut-off current: 3 A
P-1012980

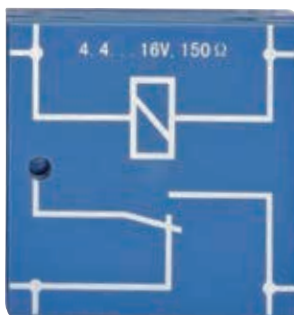

Relay with Change-Over Contacts
 Control voltage: 4–16 V DC
 Coil resistance: approx. 150 Ω
 Maximum switched power: 50 VA
P-1012992

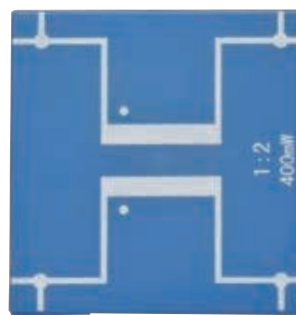

Low-Frequency Transformer, 1:2
P-1012982

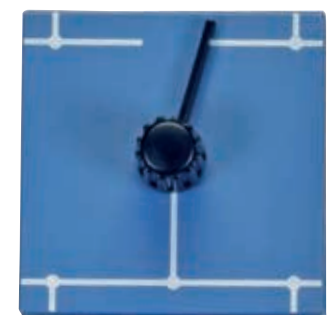

Single-Pole Change-Over Switch
P-1012993



Double-Pole Change-Over Switch
 Mechanical rocker switch with two switch positions on a square plug-in housing printed with the appropriate circuit symbol. Internal mechanical coupling with two change-over switches for each of the three switch positions to be reproduced in two circuits.
 Switch functions: 2 x ON-OFF, 2 x OFF-ON, 2 x ON-OFF-ON, 2 x Change-over
P-1012991



E 10 Socket

Art. No.	Type
P-1012986	Socket side facing
P-1012987	Socket upward facing

Additionally required:

E10 bulb from P-1010140, P-1010141, P-1010142, P-1010143, P-1010144, P-1010145, P-1010195, P-1010196, P-1010197, P-1010198 or P-1010199



Set of 10 Jumpers

Set of 10 jumpers with printed lines showing the connection between the two plugs, for assembling circuits on the plug-in component board (P-1012902).

Max. permitted current: 25 A
Plug separation: 19 mm

P-1012985

Battery Holder

Open housing with connectors for type IEC R 20 1.5-V batteries.

Plugs: 2
Plug separation: 50 mm

P-1012994

Non-inverting Schmitt trigger.

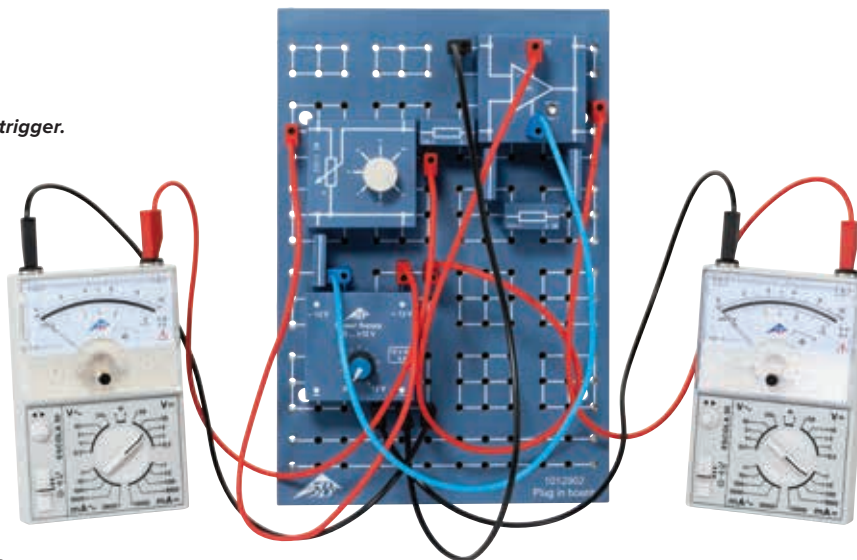

> NEW

Voltage Supply $\pm 12V$ P4W50

Symmetric, adjustable direct-voltage supply for electronic circuits, in particular, with operational amplifier LM 741 (P-1012981), e.g. non-wired, inverting and non-inverting operational amplifier, adder and subtractor, differentiating and integrating element or non-inverting Schmitt trigger. With a plug-in power supply, 12V AC, 500 mA.

- Safety transformer according to EN 61558-2-6.
- Safe isolation between the power supply network and output current circuits.

Output voltage: 0 ... +12 V, 0 ... -12 V (symmetric)
Residual ripple: < 3 mV
Output current (simultaneously per output): 150 mA, short-term 250 mA
Outputs: 4mm pins
Pin spacing: 50x50 mm²
Dimensions: approx. 65x65x70 mm³
Weight (with plug-in power supply): approx. 390 g

Voltage Supply $\pm 12V$ P4W50 (230V, 50/60 Hz)

P-1021621 £92.00

Voltage Supply $\pm 12V$ P4W50 (115V, 50/60 Hz)

P-1021622 £92.00



Experiment Topics:

- Measurement of charging and discharging curves for pairs of RC components
- Determination of ratings of integrated resistors
- Determination of ratings of integrated capacitors
- Determination of rating of an electrolytic capacitor
- Estimation of bounce times

Charge and Discharge Apparatus

Compact equipment for recording charging and discharging curves for capacitors at individual points. Includes 12 V AC plug-in power supply. The charger and discharger consists of three units in a single housing: a voltage comparator, a digital counter and three resistor-capacitor pairs. The comparator compares the charging and discharging voltages with a set comparison voltage, which can be selected from any of 11 values between 0 to 10 V. The digital counter indicates the charging and discharging times for the capacitor as soon as the set comparison voltage is attained. In addition there are pairs of sockets for connecting an external resistor and an external capacitor.

- Internal capacitor: 2067 μF
- Internal resistors: 2.2 k Ω , 5.1 k Ω , 10 k Ω
- Digital counter: 4-digit, quartz controlled
- Maximum value: 200 s
- Resolution: 100 ms
- Power supply: 12 V AC, 2000 mA plug-in power supply
- Dimensions: approx. 260x220x55 mm³
- Weight: approx. 1700 g, including plug-in power supply



**Charge and Discharge Apparatus (230 V, 50/60 Hz)
P-1017781**

**Charge and Discharge Apparatus (115 V, 50/60 Hz)
P-1017780**

Additionally recommended:

- P-1017806 Capacitor 1000 μF
- P-1012920 Resistor 4.7 k Ω
- P-1012922 Resistor 10 k Ω
- P-1012924 Resistor 22 k Ω

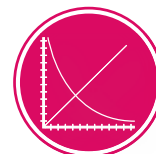

UE3050105
PDF online

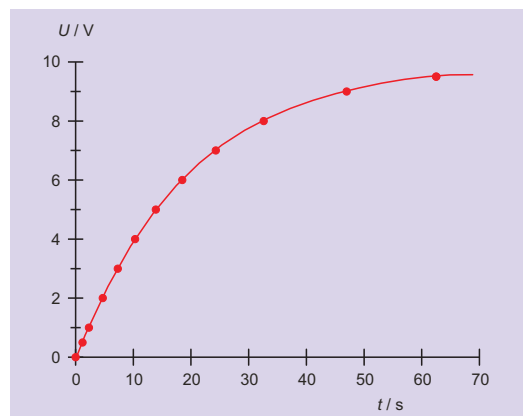

Charging curve

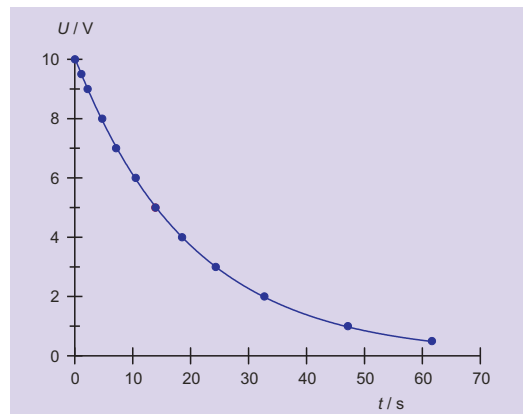

Discharging curve

Measurement at an external RC pair



Experiment Topics:

- Measurement at galvanic voltage sources
- Daniell cell, series and parallel circuits
- Electrochemical potentials (voltage sequence)
- Determination of the standard potentials of different metals and non metals
- How potentials depend on concentration
- How potentials depend on temperature
- Charge and discharge of a steel accumulator
- Leclanché cell
- Measurement of pH values

Electrochemistry Case

A complete equipment set in a case for basic experiments on electrochemistry. A cell block made of tough plastic, which can be unscrewed into two halves for ease of cleaning, allows four galvanic cells to be connected in parallel. A piece of filter paper stretched between the two halves of the cell acts as a diaphragm. Includes a handy, high-resistance meter for measuring potential differences with very little current and measuring pH values with the help of the supplied pH measuring probe.

Measurement device:

7 segment display:	3 digit
Height:	13 mm
Voltage ranges:	2 V DC and 20 V DC
Resolution:	1 mV
Input resistance:	200 M Ω
pH measuring range:	0.0 – 14.0 pH
Power supply:	Plug-in power supply, 12 V/0.5 A (as supplied) or 9-V block battery
Dimensions:	approx. 175x105x55 mm ³

Contents:

- 1 foam lined case
- 1 measurement device
- 1 pH combined electrode with BNC plug
- 1 plug-in power unit 12 V DC / 500 mA for 115/230 V AC mains voltage
- 1 Cell block, fitted with filter paper
- 2 Ag-electrodes, 42x28 mm²
- 1 Pt-electrode, 42x28 mm²
- 4 Zn-electrodes, 42x28 mm²
- 2 Fe-electrodes, 42x28 mm²
- 2 C-electrodes, 42x28 mm²
- 2 Al-electrodes, 42x28 mm²
- 2 Ni-electrodes, 42x28 mm²
- 4 Cu-electrodes, 42x28 mm²
- 1 Mg-electrode, 42x28 mm²
- 1 set of filter papers (50 units)
- 1 Sanding block for cleaning electrodes
- 3 experiment cables with crocodile clips, 20 cm, red
- 3 experiment cables with crocodile clips, 20 cm, blue
- 1 experiment cable with crocodile clip and 2 mm plug, 30 cm, red
- 1 experiment cable with crocodile clip and 2 mm plug, 30 cm, blue
- 2 graduated plastic beakers, 25 ml
- 2 drip pipettes with suction bulbs
- 1 Storage box with loose insert
- 1 operating instructions on CD-ROM

P-1002719

Additionally required:

Chemicals

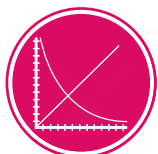

UE3020700
PDFonline

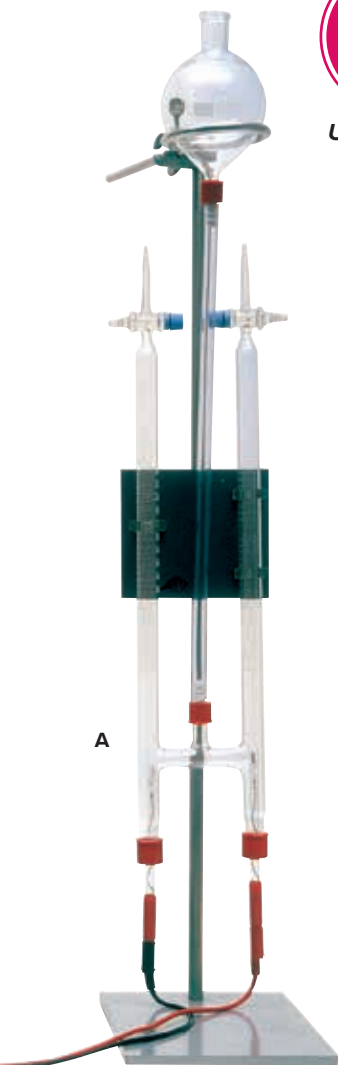

A. Hofmann's Voltmeter

Apparatus for electrolysis of water, the quantitative determination of the gases formed and establishing Faraday's laws. Consists of two scaled gas collection tubes connected by flexible plastic hose with levelling bulb for pressure compensation and hence for the exact measurement of gas volumes, on stand with retaining plate. GL threads provide secure mounting for electrodes.

Dimensions: approx. 800x150 mm²
Baseplate area: approx. 250x160 mm²
Rod: 750 mm x 12 mm diam.
Retaining plate: approx. 120x110 mm²

Contents:

1 gas collection tubes
2 platinum electrodes with 4 mm sockets
1 plastic hose with levelling bulb
1 stand ring for holding levelling bulb
1 universal bosshead
1 stand baseplate with rod and retaining plate

P-1002899

Additionally required:

P-1003312 DC Power Supply, 0 – 20 V, 0 – 5 A (230 V, 50/60 Hz)
or
P-1003311 DC Power Supply, 0 – 20 V, 0 – 5 A (115 V, 50/60 Hz)



B. Hofmann's Voltmeter S

Hofmann's voltameter is used for determining the chemical composition of water by volume. The apparatus consists of three vertical glass tubes connected to each other at the bottom. Taps at the top ends of the outside tubes are closed whilst the inner cylinder is open at the top to allow the addition of water via a reservoir. Gold sheet electrodes are fitted to the lower ends of the outside tubes and connected to a low-voltage power supply. The proportion of hydrogen and oxygen produced by electrolysis from the water can be read from the graduations on the side tubes. By opening the taps at the top of the tubes, gases can be collected for analysis. Carbon electrodes are also available for analysis of solutions where gold is unsuitable.

Dimensions: approx. 580x150 mm²
Stand base, A-shaped: 115 mm leg length
Operating voltage: 4 – 12 V DC

P-1003507

Additionally required:

P-1003312 DC Power Supply, 0 – 20 V, 0 – 5 A (230 V, 50/60 Hz)
or
P-1003311 DC Power Supply, 0 – 20 V, 0 – 5 A (115 V, 50/60 Hz)

Additionally recommended:

P-1003508 Carbon Electrodes

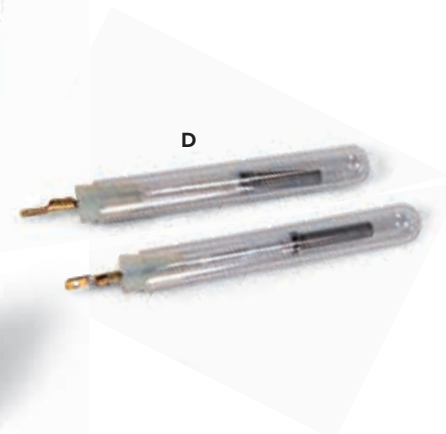

C. Daniell Cell

Galvanic cell (Daniell cell) named after John Frederic Daniell for studying the properties of an electrochemical cell. The Daniell cell consists of a cylindrical zinc and copper electrode, a clay vessel and a battery glass. Filled with cell electrolyte the Daniell cell supplies a voltage of approx. 1.1 volts. The cell is delivered empty.

Connections: 4 mm jacks
Dimensions: approx. 105 mm x 65 mm diam.
Suitable filling: Copper sulphate solution (CuSO₄), 10% concentration,
Zinc sulphate solution (ZnSO₄), 10% concentration

P-1002898

D. Carbon Electrodes

Pair of graphite electrodes for use with the Hofmann's voltameter S (P-1003507) for the analysis of ammonia solutions, solutions of table salt or other solutions with chloride radicals.

P-1003508

Equipment Set for Electrochemistry

Set for measuring electrochemical potentials of various metals in experiments intended for students. Includes digital multimeter.

Trough: approx. 85x70x45 mm³

Electrodes: approx. 76x40 mm²

Contents:

- 1 flat trough
- 1 copper plate
- 1 zinc plate
- 1 iron plate
- 2 nickel plates
- 1 aluminum plate
- 2 electrolyte-carbon plates
- 1 digital multimeter with 2 cables with crocodile clamps

P-1002711



Electrode plates (not shown)

Spare electrodes for the electrochemistry equipment set (P-1002711).

Dimensions: approx. 76x40 mm²

Art. No.	Material
P-1002712	Set of 10 Copper Plates
P-1002713	Set of 10 Zinc Plates
P-1002714	Set of 10 Iron Plates
P-1002715	Set of 5 Nickel Plates



Leclanché Cell

This model of a dry battery was invented by the French chemist Georges Leclanché in the 1860s. It consists of a cylindrical zinc electrode, a rod shaped carbon electrode, a clay vessel and a battery glass. Filled with cell electrolyte, the Leclanché cell supplies a voltage of approximately 1.5 volts. The cell is delivered empty.

Connections: 4 mm jacks
 Dimensions: approx. 175 mm x 65 mm diam.
 Suitable filling: Ammonium chloride solution (NH₄Cl), approx. 20% concentration

P-1002897

Experiment Topics:

- Conductors and non-conductors
- Determining electrolytes
- Distinguishing between 5 typical electrolytes

E. Conductivity Tester

Easy to use meter for determining conductivity of electrolytes (in water courses) and distinguishing between distilled water, rain water, tap water, brine and sea water, as well as between acids and alkalis. The display indicates the levels “very low”, “low”, “medium”, “high” and “very high” and has LED backlighting. Even the very low conductivity of distilled water is displayed. The device is protected against spray and can therefore be used without difficulty in the open air. It can be powered either by a 9-V block battery (not included) or by the supplied 12-V/500-mA plug-in power supply.

Measuring ranges:

- 2 – 20 μS/cm (very low),
- 20 – 100 μS/cm (low),
- 100 – 500 μS/cm (medium),
- 500 – 3000 μS/cm (high),
- > 3000 μS/cm (very high)

Dimensions: approx. 85x35x170 mm³

Battery capacity: approx. 10 hours

P-1012890

Additionally required:

P-1012889 Conductivity Electrode



F. Conductivity Electrode

Conductivity electrode for use with conductivity tester (P-1012890). With platinum wires and 0.8 m of cable tipped by two 4-mm plugs.

Cell constant: approx. 1/cm

Dimensions: 130 mm x 15 mm diam.

P-1012889

Magnetic Equipment Set

A selection of various magnets for introducing the subject of magnetism. Complete with a specially moulded storage tray.

Contents:

- 3 AlNiCo round magnets: 12 mm, 19 mm, 24 mm diam.
- 1 AlNiCo horseshoe magnet, 25 mm long
- 1 Chromium-steel horseshoe magnet, 100 mm long
- 2 Chromium-steel bar magnets, 100 mm x 6 mm diam.
- 2 Bar magnets in a protective plastic case, 80 mm long
- 5 Iron ring magnets, 25 mm diam.
- 5 Iron magnets, 19x19x5 mm³
- 1 Natural magnet
- 4 Coloured magnetic foils, 50x50 mm²
- 2 Drawing compasses, 19 mm diam.
- 2 Drawing compasses, 16 mm diam.

P-1003089

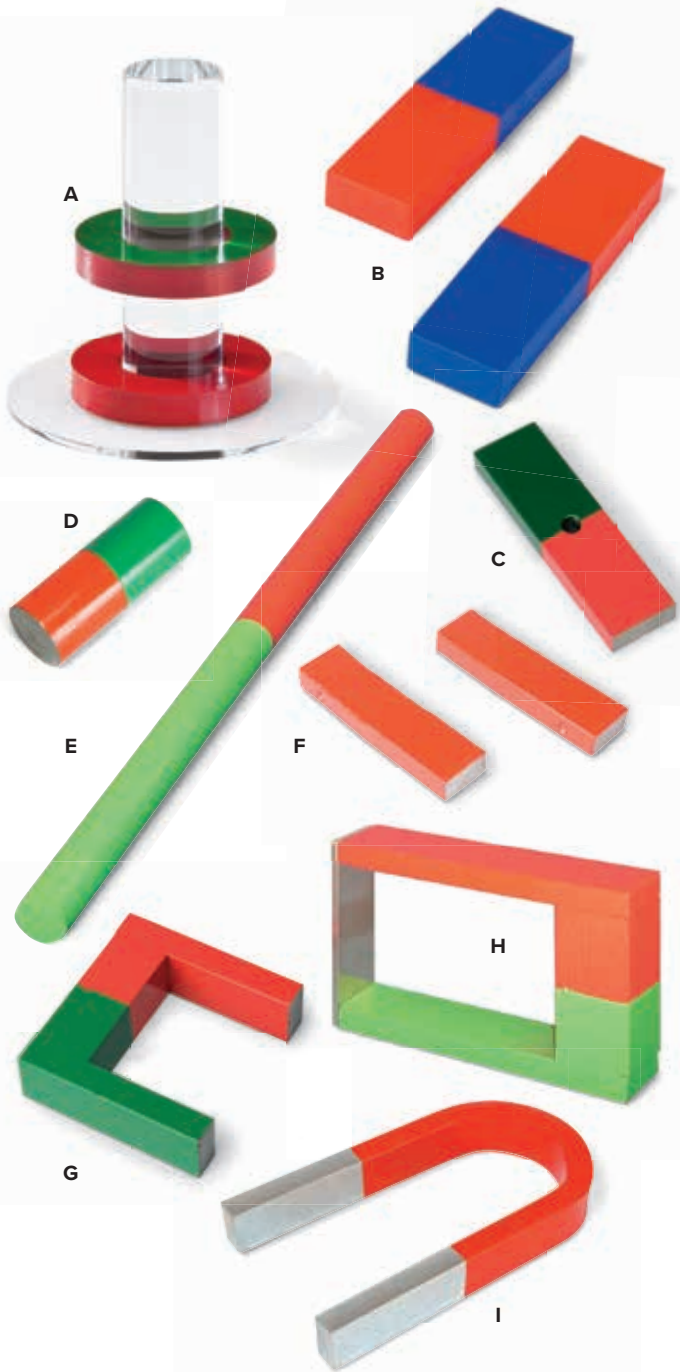

A. Suspended Magnet

Apparatus for demonstrating repulsion forces between magnets. Two ring magnets facing each other with identical poles are placed onto a rod.

Base: approx. 100 mm diam.
Rod: approx. 100 mm x 30 mm diam.
Weight: approx. 410 g

Contents:

- 1 Rod with Base
- 2 Ring magnets

P-1000943

B. Pair of Bar Magnets, 80 mm

Pair of bar magnets with poles marked red and blue. In plastic protective cover.

Dimensions: approx. 80x22x10 mm³

P-1003085

C. Bar Magnet, AlNiCo, 70 mm

AlNiCo bar magnet with poles marked red and green.

Dimensions: approx. 70x20x8 mm³
Weight: approx. 80 g

P-1003554

D. Cylindrical Bar Magnet 50x20

Round bar magnet with poles marked red and green.

Dimensions: approx. 50 mm x 20 mm diam.

P-1003556

E. Cylindrical Bar Magnet 200x10

Round bar magnet with poles marked red and green.

Dimensions: approx. 200 mm x 10 mm diam.

P-1003112

F. Pair of Bar Magnets, AlNiCo, 60 mm, with Two Iron Yokes

Pair of AlNiCo bar magnets, red, with north pole marked. Including two iron yokes.

Dimensions: approx. 60x15x5 mm³

P-1003086

G. Horseshoe Magnet, 70 mm

Horseshoe shaped AlNiCo magnet. Poles marked red and green.

Pole area: approx. 20x10 mm²
Distance between poles: approx. 50 mm
Length of shank: approx. 70 mm
Weight: approx. 400 g

P-1000929

H. Horseshoe Magnet 130 mm, with Yoke

Horseshoe shaped magnet with yoke. Poles coloured red/green.

Pull-off force of yoke: 250 N
Pole spacing: approx. 60 mm
Length: approx. 130 mm

P-1003114

I. Horseshoe Magnet 140 mm, with Yoke

Horseshoe shaped stainless steel magnet with yoke, poles coloured red and silver.

Pole area: approx. 20x10 mm²

Distance between poles: approx. 60 mm
Length of shank: approx. 140 mm

P-1003088

Equipment Kit "Hysteresis Curve"

Apparatus for recording the magnetic flux density as a function of the magnetic field strength in different samples.

Dimensions of the

iron samples: approx. 140 mm x 10 mm diam.

Number of turns: 850

Internal resistance: 3.2 Ω

Inductance

without core: 3.2 mH

Dimensions: approx. 200x145x65 mm³

Total weight: approx. 470 g

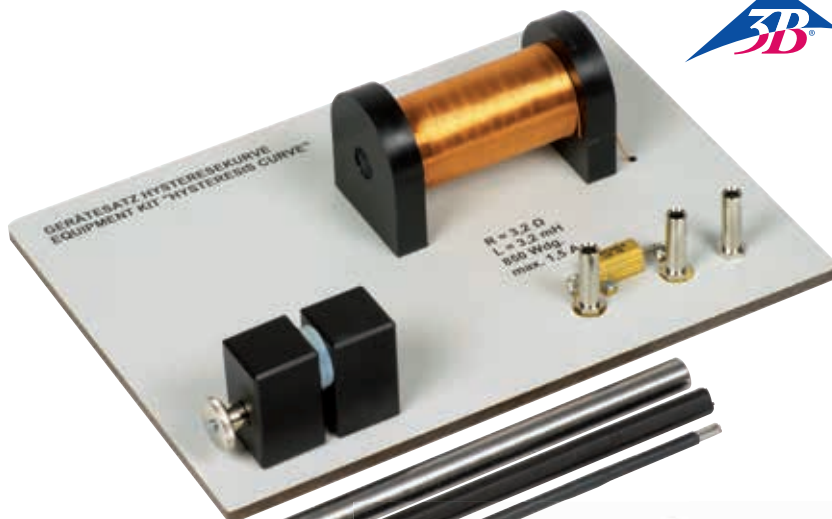

Contents:

Base plate with coil and holder for Hall sensors

3 Material samples (Vacon 11, spring steel and silver steel)

P-1018889

Additionally required:

P-1009957 Function Generator FG 100 (230 V, 50/60 Hz)

or

P-1001036 Function Generator FG 100 (115 V, 50/60 Hz)

Additionally recommended:

P-1001040 Magnetic Field Sensor, Axial/Tangential

P-1008537 Teslameter E

P-1020910 Digital Oscilloscope 2x30 MHz

Soft-Iron Bars

Set of 5, non-magnetic soft-iron bars for magnetic induction experiments.

Dimensions: approx. 155 mm x 10 mm diam.

P-1003090

Lodestone

Unfinished, walnut-sized stone made of magnetic iron ore (magnetite).

P-1003091



Compass Magnet with Plastic Bowl

Very powerful neodymium magnet covered with a plastic case which can float on the surface of water and faces North South when it comes to rest.

Complete with translucent plastic bowl marked with compass points.

Dimensions:

Magnet: 80 mm x 30 mm max diam.

Bowl: approx. 40 mm x 115 mm diam.

P-1003096



"Oersted's Needle" Device

Compact and easy to understand apparatus to demonstrate Oersted's experiment.

An electric current passing through a piece of enamelled copper wire creates a magnetic field around the wire, which can deflect a magnetic compass needle from its normal position.

Dimensions of base: 200x80 mm²

Copper wire: 3 mm diam.

Electrical

connections: 4 mm safety sockets

Maximum permissible current: 5 A

P-1009710

Additionally recommended:

P-1003312 DC-Power Supply 0 – 20 V,

0 – 5 A (230 V, 50/60 Hz)

or

P-1003311 DC-Power Supply 0 – 20 V,

0 – 5 A (115 V, 50/60 Hz)





Globe with Bar Magnet

Globe of the World with bar magnet along the axis of the Poles on an acrylic base, this demonstrates the shape of the Earth's magnetic field. A compass (P-1003093) or a magnetic field indicator (P-1003555) can be seen to align at the surface of the globe in accordance with a magnetic field parallel to the lines of longitude. The inclination can also be determined using the magnetic field sensor.

Dimensions: approx. 220x160x200 mm³
 Diameter (globe): approx. 120 mm
 Weight: approx. 340 g

P-1013123

Additionally recommended:

P-1003555 Magnetic Field Indicator

P-1003093 Compass



Experiment: Determination of the horizontal and vertical components of the Earth's magnetic field

Equipment:

P-1000906 Helmholtz Coils 300 mm

P-1003312 DC Power Supply 0 – 20 V, 0 – 5 A (230 V, 50/60 Hz)

or

P-1003311 DC Power Supply 0 – 20 V, 0 – 5 A (115 V, 50/60 Hz)

P-1002781 Digital Multimeter P1035

P-1006799 Inclination Instrument E

P-1003066 Rheostat 100 Ω

P-1002843 Set of 15 Safety Experiment Leads, 75 cm

Magnetic Field Indicator

Bar magnet, with Poles identified by colour and free to turn in space, for three-dimensional mapping of magnetic fields. On agate gimbal bearings pivot allowing free rotation in space, small bar magnet with colour pole coding. The handle and cardanic suspension are made of plastic to alleviate any adverse effects on magnetic field.

Magnet: approx. 25x3x3 mm³
 Handle length: approx. 95 mm

P-1003555

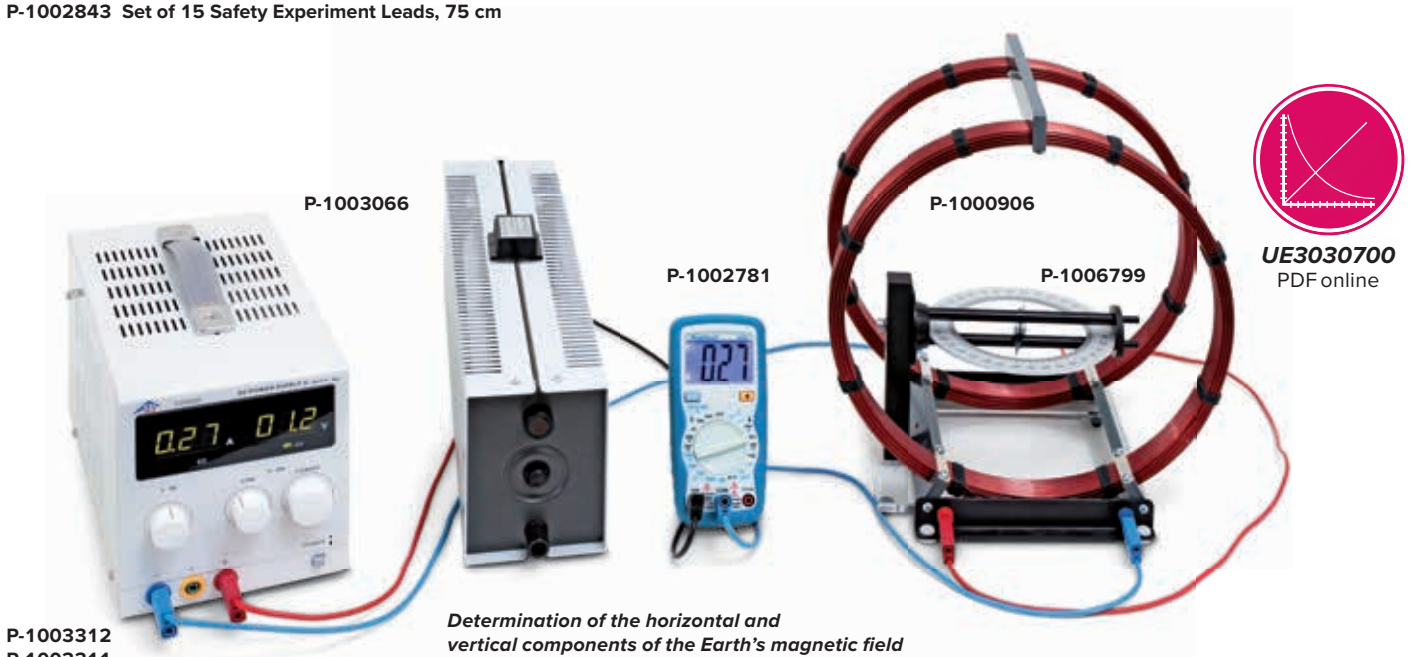

P-1003312
P-1003311

Determination of the horizontal and vertical components of the Earth's magnetic field

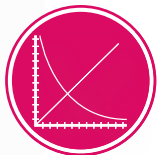

UE3030700
 PDF online



Inclination Instrument E

Instrument for measuring the inclination of the Earth's magnetic field and also for mapping the magnetic field of a current-carrying conductor. The agate bearings hold the magnetic needle which is mounted in a frame with reference circle. The frame is equipped with an additional reference circle. There are two 4 mm sockets included for the power supply.

Length of magnetic needle: approx. 100 mm
 Dimensions: approx. 180x100x220 mm³
 Weight: approx. 620 g

P-1006799

Additionally recommended:

P-1003312 DC Power Supply 0 – 20 V, 0 – 5 A (230 V, 50/60 Hz)

or

P-1003311 DC Power Supply 0 – 20 V, 0 – 5 A (115 V, 50/60 Hz)



Inclination Instrument

Instrument for measuring the inclination of the Earth's magnetic field and also for mapping the magnetic field of a current-carrying conductor. An aluminium conductor loop with 4 mm safety sockets, a magnetic needle with a pointed axle rotates on bearings above a full circle in transparent material with an angle scale, rotating around the horizontal axis and mounted on an acrylic base.

Diameter of circle: approx. 110 mm
 Length of magnetic needle: approx. 100 mm
 Strap length: approx. 150 mm
 Terminal: 4 mm safety sockets
 Base dimensions: approx. 100x90x185 mm³

P-1003192

Additionally recommended:

P-1003312 DC Power Supply 0 – 20 V, 0 – 5 A (230 V, 50/60 Hz)

or

P-1003311 DC Power Supply 0 – 20 V, 0 – 5 A (115 V, 50/60 Hz)



A. Compass

Compass in a stable housing, low friction needle bearing, including a compass card and angle scale.

Scale division: 2°
 Diameter: approx. 45 mm

P-1003093

B. Magnetic Needle, 80 mm

Magnetic needle mounted on base with pivot point.

Length: approx. 80 mm
 Height: approx. 110 mm

P-1000674

C. Set of 10 Tracing Compasses

Set of 10 compasses for tracing field lines. Aluminium housing, glazed on both sides. Markings for indicating compass directions.

Diameter: approx. 19 mm

P-1003095

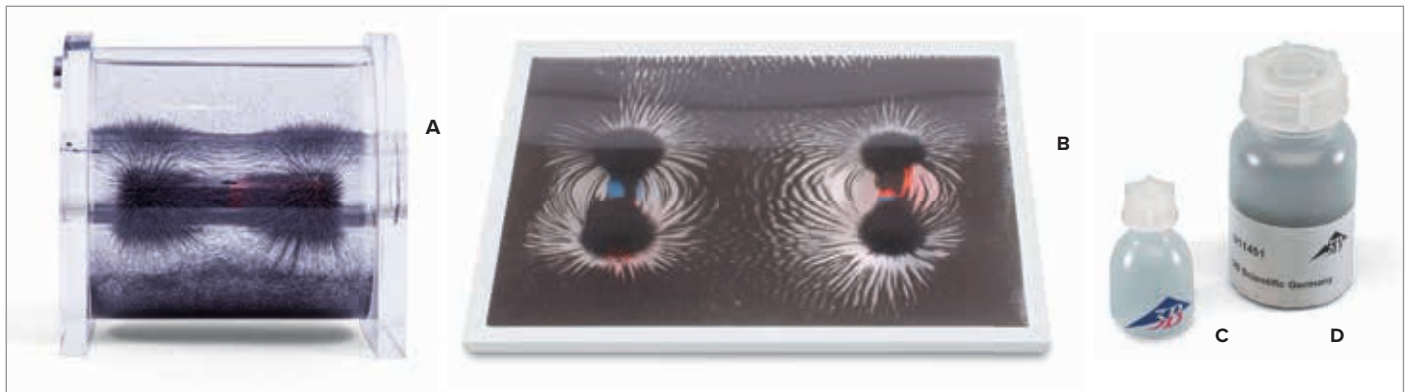

A. Three-Dimensional Magnetic Field Lines Device

Instrument for three-dimensional mapping of the magnetic field lines of a cylindrical bar magnet. The acrylic housing is filled with a special, highly viscous liquid and iron filings. After the magnet has been inserted into the central hole, the iron filings, which had previously been distributed randomly in the liquid, align themselves according to the direction of the field. An enclosed air bubble ensures that a good shake of the device causes the iron shavings to be evenly distributed.

Diameter of the hole: approx. 21 mm
 Dimensions: approx. 120x110x110 mm³
 Weight: approx. 0.8 kg

P-1009765

Additionally required:

P-1003556 Cylindrical Bar Magnet 50x20 mm

B. Two-Dimensional Magnetic Field Line Apparatus

Demonstration apparatus for two-dimensional display of magnetic field lines in combination with an overhead projector. It consists of a transparent plastic vessel filled with a liquid containing magnetic powder. Magnets and an experiment manual in English are included.

Dimensions: approx. 220x120x10 mm³

P-1003092

Additionally required:

Overhead projector

C. Shaker

Plastic flask with a fine hole for scattering iron filings evenly.

P-1000581

D. Iron Filings

250 g of iron filings for displaying magnetic field lines. In a storage flask.

P-1000580

Additionally recommended:

P-1000581 Shaker



Hexagonal Magnet Model

Demonstration apparatus for the properties of the crystal lattice of ferromagnetic materials, particularly Weiss domains, Barkhausen jumps, saturation, hysteresis and Curie temperature. 118 freely moving magnetic needles are supported in a hexagonal arrangement between two connected transparent acrylic plates. For projection on the overhead projector.

Length of magnetic needles: approx. 11 mm
 Dimensions of plate: approx. 150x150 mm²

P-1002975

Additionally recommended:

Overhead projector

P-1000942 Pair of Flat Coils



Pair of Flat Coils

Pair of coils for generating a near-uniform magnetic field for the hexagonal and cubic magnet models (P-1002975 and P-1002976). This makes it possible to observe changes in the magnetic flux when the magnetisation is changed.

Number of turns: 125
 Resistance: approx. 7 Ω
 Permitted current: 1 A
 Dimensions: approx. 150x30x18 mm³
 Weight: approx. 85 g

P-1000942

Additionally recommended:

P-1003312 DC-Power-Supply 0 – 20 V, 0 – 5 A (230 V, 50/60 Hz)

or

P-1003311 DC-Power-Supply 0 – 20 V, 0 – 5 A (115 V, 50/60 Hz)



Magnet Model, Cubic

Like P-1002975, but with magnets in a square arrangement.

P-1002976

Additionally recommended:

Overhead projector

P-1000942 Pair of Flat Coils

Experiment Topics:

- Magnetic flux lines of bar and horseshoe magnets
- Magnetic screening
- Magnetic induction
- To display the shapes adopted by magnetic field lines around a straight conductor, a conductor loop, a cylindrical coil, and an electromagnet



Set of Apparatus for Displaying Magnetic Fields

Equipment set for demonstration experiments designed to make visible the magnetic field distribution of permanent magnets and current carrying conductors. Also compatible for use with a daylight projector. The acrylic glass boxes containing iron filings are equipped with a pouring lip so that the used fillings can easily be refilled into the storage bottle.

Acrylic glass boxes: approx. 185x125x40 mm³
 Storage tray: approx. 430x380x25 mm³
 Weight: approx. 1.5 kg

Contents:

- 1 Straight conductor mounted on box made of transparent acrylic
- 1 Ring-shaped conductor mounted on box made of transparent acrylic
- 1 Cylindrical coil mounted on box made of transparent acrylic
- 1 Magnetic overlay with guide studs on acrylic box
- 1 Acrylic plastic box with smooth surface for scattering materials
- 2 Soft iron bars
- 1 Flat soft iron bar
- 2 Permanent flat bar magnets
- 1 Soft iron ring
- 1 Magnetic needle with holder
- 1 Scattering bottle with iron filings
- 1 Pre-molded storage tray

P-1000925

Additionally required:

P-1002771 DC-Power Supply, 0 – 16 V, 0 – 20 A (115/230 V, 50/60 Hz)

Additionally recommended:

Overhead Projector

Current Conductor on Acrylic Base

Current Conductor for demonstrating the magnetic fields of current-carrying conductors. The magnetic field can be made visible with iron powder. Acrylic glass base with two 4 mm safety sockets. For projection on the overhead projector.

Dimensions of acrylic glass base: approx. 185x150x30 mm³

Straight Conductor on Acrylic Base

P-1000926

Loop-Shaped Conductor on Acrylic Base

P-1000927

Coil on Acrylic Base

Number of turns: 7
 Coil diameter: approx. 35 mm
 Coil length: approx. 65 mm

P-1000928

Additionally required:

P-1002771 DC-Power Supply, 0 – 16 V, 0 – 20 A (115/230 V, 50/60 Hz)

P-1000580 Iron Filings

P-1000581 Shaker

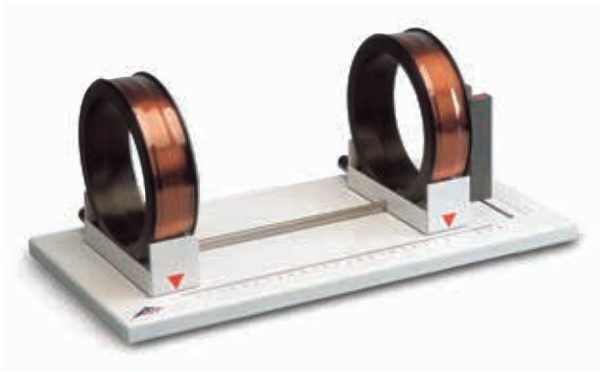

Pair of Helmholtz Coils on Mounting Plate

Pair of coils with variable separation for determining the optimum Helmholtz configuration and for quantitative testing of the uniformity of the magnetic field. The apparatus comprises a pair of coils arranged parallel to each other, mounted on a robust metal base plate with a holder for a magnetic field meter to measure the magnetic field. One coil and its holder are moveable. There are two scales printed on the base plate to allow coil separation to be read off and to determine how far the measurement probe's position deviates laterally from the coil axis respectively.

Average coil diameter: 125 mm
 Number of turns: 100 each
 Max. coil separation: 240 mm
 Max. permissible current: 5 A
 Terminals: 4 mm safety sockets
 Base plate: approx. 400x200 mm²

P-1003193



Magnetising Coil

This solenoid allows you to magnetise and demagnetise ordinary magnets or iron bars in addition to conducting inductance experiments. The rugged unit consists of insulated copper winding, mounted on a base with 4mm sockets and a switch.

Windings: 1000
 Coil length: 250 mm
 Coil radius: 35 mm internal
 Operating Voltage: max. 12 V DC or 12 V AC
 Dimensions: approx. 305x200x100 mm³
 Mass: approx. 2 kg

P-1003237

Stand for Cylindrical Coils

Made of acrylic.
 Dimensions: approx. 165x120x75 mm³
 Weight: approx. 185 g

P-1000964

*Measurement of the magnetic field
 around a current carrying coil*



A. Coil with Variable Number of Turns per Unit Length

Cylindrical coil of variable length for investigating the magnetic field strength as a function of the closeness of the turns.

Coil diameter: 100 mm
 Number of turns: 30
 Coil length: 490 mm
 Max. Current: 10 A, for short periods 20 A
 Terminal: 4 mm safety sockets

P-1000965

Additionally recommended:

P-1000964 Stand for Cylindrical Coils

Field Coils

Cylindrical coils for experiments investigating magnetic field intensity as a function of the current and the number of turns, for demonstrating that the field intensity is independent of the coil cross section. Coil bobbins made of acrylic.

Number of turns: 120
 Coil length: 490 mm
 Max. current: 10 A, for short periods 20 A
 Terminal: 4 mm safety sockets

B. Field Coil 100 mm diam.

P-1000591

C. Field Coil 120 mm diam.

P-1000592

Additionally recommended:

P-1000964 Stand for Cylindrical Coils

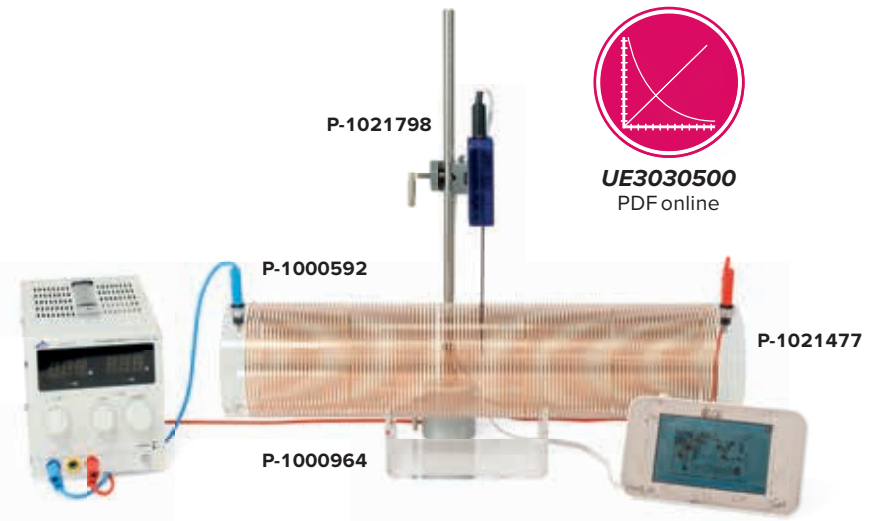

UE3030500
 PDF online

Determining the Helmholtz Configuration: Measurement of Magnetic Field for a Pair of Coils with Variable Separation



Art. No.	Description
P-1003193	Pair of Helmholtz Coils on Mounting Plate
P-1021669	Teslameter N (230 V, 50/60 Hz)
or	
P-1021671	Teslameter N (115 V, 50/60 Hz)
P-1003312	DC Power Supply 0 – 20 V, 0 – 5 A (230 V, 50/60 Hz)
or	
P-1003311	DC Power Supply 0 – 20 V, 0 – 5 A (115 V, 50/60 Hz)
P-1002849	Pair of Safety Experiment Leads, 75 cm

Measurement of the magnetic field for a pair of coils with variable separation

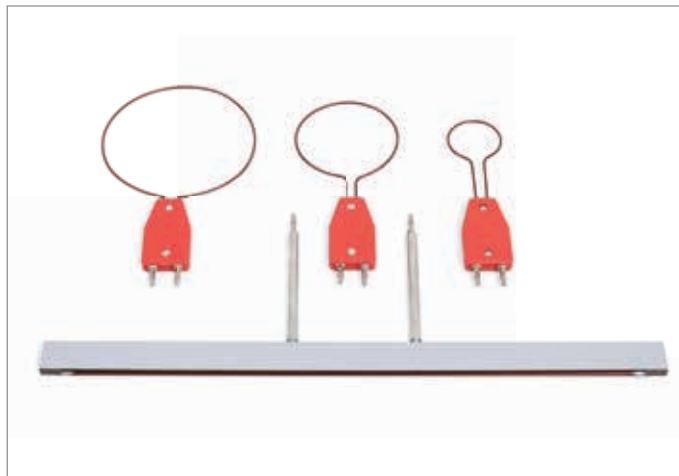

Set of Four Conductors for Biot-Savart Experiments

Equipment set comprising a straight conductor and three circular ones for experimental investigation of how magnetic flux density is calculated according to the Biot-Savart law.

- Connectors: 4-mm plug
- Maximum continuous current: 20 A
- Diameter of circular conductors: 120 mm, 80 mm and 40 mm
- Length of straight conductor: 350 mm

P-1018478

Additionally recommended:

- P-1018449 Holder for Plug-in Components
- P-1019212 Holder for Magnetic Field Sensor
- P-1012892 Flexible Magnetic Field Sensor
- or
- P-1001040 Magnetic Field Sensor, Axial/Tangential
- P-1008537 Teslameter E
- P-1003040 Optical Bench U, 600 mm
- P-1003041 Optical Rider U, 75 mm (2x)
- P-1002771 DC Power Supply 0 – 16 V, 0 – 20 A
- P-1002849 Pair of Safety Experiment Leads, 75 cm



Holder for Magnetic Field Sensor

Holder on a stem to accommodate magnetic field sensor in experiments to confirm the Biot-Savart law.

P-1019212



P-1002771

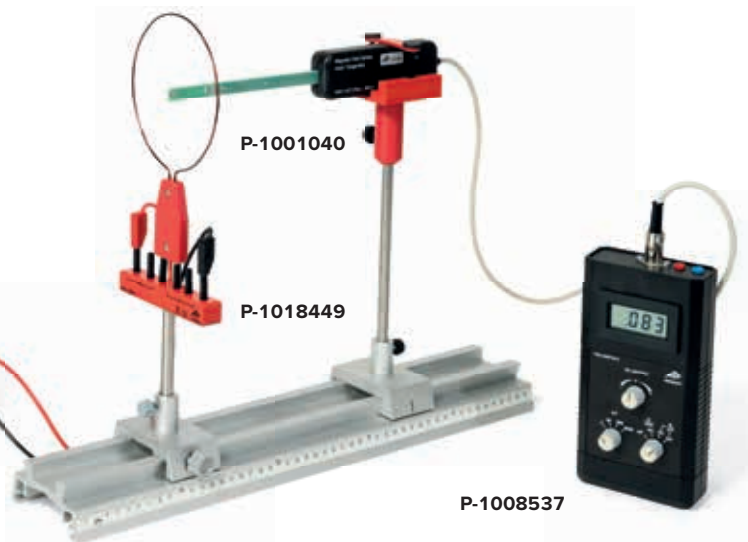

P-1001040

P-1018449

P-1008537

Current Balance Equipment Set

Equipment set for measuring force on a current-carrying conductor in a magnetic field as a function of the current, of the magnetic field or of the length of the conductor. The force is composed of the apparent change in the weight of the holder for the permanent magnets, which is measured by means of a sensitive set of scales.

Max. current: 5 A
Weight: approx. 500 g

Contents:

6 Conductors
Holder for permanent magnets
6 Permanent magnets
Folding power feed and holder for conductors

P-1021822

Additionally required:

P-1002933 Steel Rod 25 cm
P-1002835 Tripod Stand, 150 mm
P-1002850 Pair of Experiment Leads
P-1020859 Electronic Scale Scout SKX 420 g
P-1003312 DC Power Supply 0 – 20 V, 0 – 5A (230 V, 50/60 Hz)
or
P-1003311 DC Power Supply 0 – 20 V, 0 – 5A (115 V, 50/60 Hz)

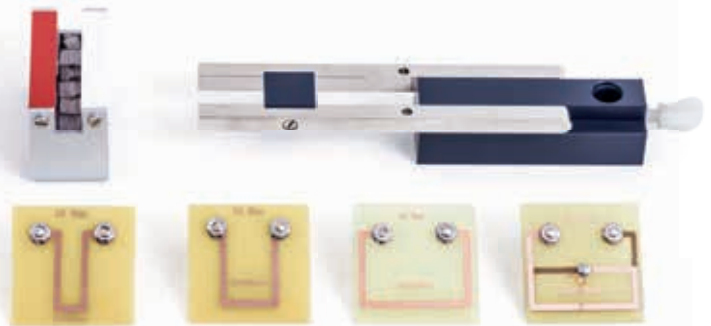

Lorentz Force Apparatus

The apparatus consists of a powerful U shaped magnet, a pair of brass rails complete with 4mm sockets and a brass axle. A power supply unit is connected to the rails. When the axle is placed on the rails the electric circuit is completed and the axle is repelled along the rails in a direction either towards or away from the magnetic field. Reversing the current will have the opposite effect.

Dimensions: approx. 175x65x70 mm³

P-1003251

Additionally required:

P-1003312 DC Power Supply 0 – 20 V, 0 – 5 A (230 V, 50/60 Hz)
or
P-1003311 DC Power Supply 0 – 20 V, 0 – 5 A (115 V, 50/60 Hz)

Experiment Topics

- Diamagnetism and paramagnetism
- Waltenhofen's pendulum
- Force on a conductor in a magnetic field in parallel and transverse configurations
- Measuring currents with a current balance

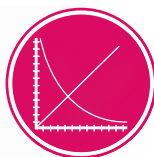
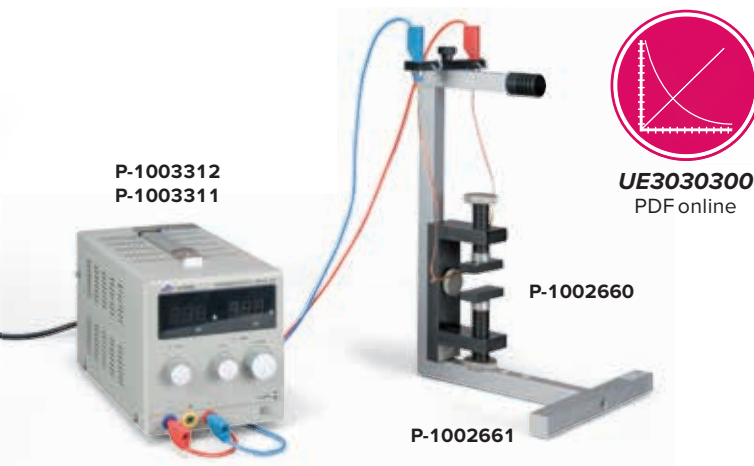

UE3030300
PDF online



Equipment Set Electromagnetism

This equipment consists of a stable, firm, anodised-aluminium tripod with pre-defined magnet positions and accessory mountings. The deflection of the conductor swing can be adjusted in steps of 0, 15, 30 and 45 mm for current balance experiments.

Contents:

- 1 Aluminium tripod, anodised
- 1 Conductor swing with 4 mm safety jacks
- 2 Waltenhofen pendulums (solid and slotted)
- 1 Glass rod and polyester thread with hook
- 1 Aluminium rod and polyester thread with hook
- 1 Knurled screw

P-1002661



Lorentz Motor

Comprising a motor armature without an iron core, this device is intended for installation inside the permanent magnet with adjustable pole spacing (P-1002660). The coil is rotated purely by the Lorentz force, its direction of rotation depending on the direction of the current.

P-1002662

Additionally required:

- P-1002660** Permanent Magnet with Adjustable Pole Spacing
- P-1003312** DC Power Supply 0 – 20 V, 0 – 5 A (230 V, 50/60 Hz)
- or
- P-1003311** DC Power Supply 0 – 20 V, 0 – 5 A (115 V, 50/60 Hz)

Additionally required:

- P-1002660** Permanent Magnet with Adjustable Pole Spacing
- P-1003312** DC Power Supply 0 – 20 V, 0 – 5 A (230 V, 50/60 Hz)
- or
- P-1003311** DC Power Supply 0 – 20 V, 0 – 5 A (115 V, 50/60 Hz)

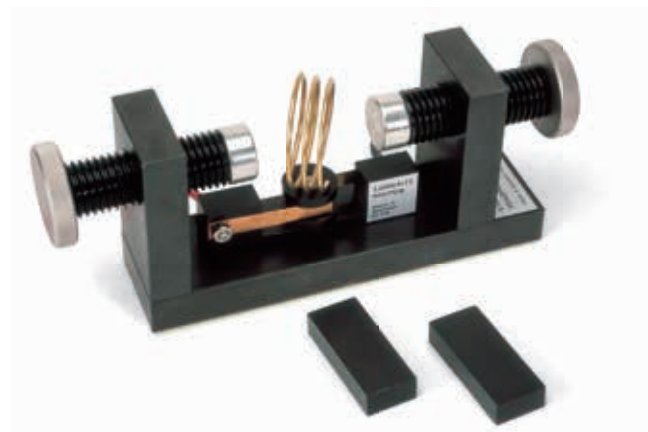

Permanent Magnet with Adjustable Pole Spacing

This permanent magnet has an adjustable pole spacing and a high field strength arising from the use of two neodymium magnet elements. It comes with a black-finished iron yoke, knurled handles made of high-grade steel and attachable pole shoes. This magnet system can be installed horizontally or vertically.

Magnet:	20x10 mm ²
Pole shoes:	20x50 mm ²
Pole spacing:	2 – 80 mm
Field strength at centre of gap:	20 mT – 1000 mT

P-1002660

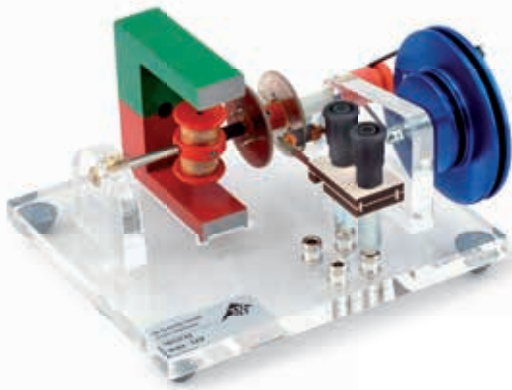

Electric Motor and Generator, Complete

Functioning model for demonstration of how a DC motor, as well as DC and AC generators, work. The model is equipped with a commutator, slip ring, pick-ups and armature coil and is mounted on a transparent acrylic plate with connection sockets, drive pulley and rubber drive belt. Includes horseshoe magnet, 70 mm.

Dimensions: approx. 130x150 mm²

Weight: approx. 850 g

P-1017801



Operating as an AC generator



Operating as a DC generator

Induction Apparatus

Apparatus for demonstrating the induced voltage in a frame coil that is moved through the magnetic field produced by a magnet plate of limited area or by the rotation of a current-carrying conductor in the magnetic field of the magnet plate. By varying the speed of motion of the frame coil, the direction of motion and the number of turns in the coil, the induction law can be derived experimentally and quantitatively. The transparent design of the magnetic plate and coils means that they can be demonstrated on the overhead projector. An unfoldable support permits inclined set-up.

Operating voltage: 2–12 V DC

Frame coil: approx. 185x125 mm²

Total dimensions: approx. 585x200x55 mm³

Weight: approx. 3 kg

Contents:

1 Induction apparatus with retractable magnetic plate

1 Frame coil

1 Rolling conductor loop

P-1000968

Additionally required:

P-1003312 DC-Power Supply Unit 0 – 20 V, 0 – 5 A (230 V, 50/60 Hz)
or

P-1003311 DC-Power Supply Unit 0 – 20 V, 0 – 5 A (115 V, 50/60 Hz)

P-1013526 Analogue Multimeter Escola 30

Additionally recommended:

Overhead Projector

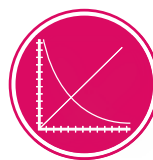

UE3040200

PDF online

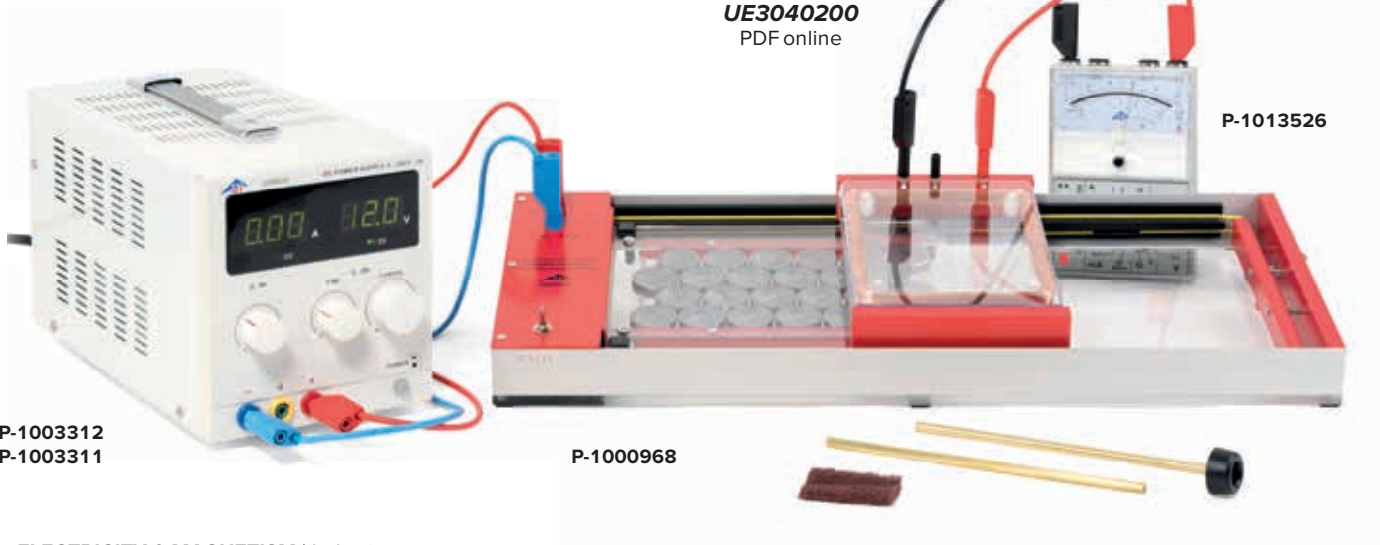

P-1003312

P-1003311

P-1000968

P-1013526



Tube with Six Induction Coils

Plastic tube with six identical induction coils connected in series. When the bar magnet provided is allowed to fall through the tube, a voltage is induced in each of the coils in turn. As the velocity of the magnet increases with time during its fall, the amplitudes of the voltage peaks also increase, and their width decreases. The area under each voltage peak remains constant.

Coil width: 10 mm
 Distance between coils: 190 mm
 Dimensions: approx. 1500 mm x 20 mm diam.
 Weight: approx. 500 g

P-1001005

Additionally required:

- P-1021478** €Lab
- P-1021681** Voltage Sensor 500 mV, Differential
- P-1021514** Sensor Cable

Flat Coil in a Rotatable Frame

Flat coil in a plexiglas frame, mounted so that it can be rotated, for use in combination with 300 mm Helmholtz coils (P-1000906). When the flat coil is rotated in the magnetic field of the Helmholtz coils, an alternating voltage is induced. The electrical connection to the coil is established via sliding contacts. A hand crank and pulley on the rotary frame's axle are used to drive the coil.

Number of turns: 4000
 Effective area: 42 cm²
 Dimensions: approx. 110x80x11 mm³
 Weight: approx. 360 g

P-1013131

Additionally required:

- P-1000906** Helmholtz Coils, 300 mm
- P-1013526** Analogue Multimeter Escala 30
- P-1003312** DC-Power Supply Unit 0 – 20 V, 0 – 5 A (230 V, 50/60 Hz)

or

- P-1003311** DC-Power Supply Unit 0 – 20 V, 0 – 5 A (115 V, 50/60 Hz)

Helmholtz Coils 300 mm

Pair of coils with large diameter in Helmholtz configuration used to produce a homogeneous magnetic field. The coils can be switched in parallel or in series. A spring clip on the top crossbar is used to mount the Hall sensor during measurements of the magnetic field.

Coil diameter: approx. 300 mm
 Number of turns per coil: 124 each
 DC resistance: 1.2 Ω each
 Maximum coil current: 5 A each
 Terminals: 4 mm safety sockets
 Weight: approx. 4.1 kg

P-1000906



The induced voltage as a function of time

P-1001005

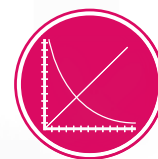

UE3040100
 PDF online

P-1021478
P-1021681

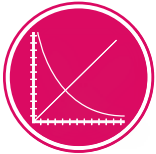

UE3040400
PDF online



Waltenhofen's Pendulum

Equipment set for the demonstration of the effects of eddy currents and braking. A pendulum object composed of a solid steel plate swings back and forth between the poles of an electromagnet with the power switched off. When the magnet is switched on, the pendulum motion of the object comes to an almost immediate halt. If the plate contains slots more time elapses before the plate stops moving, i.e. the braking effect is severely reduced. The equipment set consists of a pendulum rod and four aluminium pendulum plates with various shapes: rectangle, rectangle with slits, circular disk, ring and ring with slits.

Rectangular: approx. 100x60 mm²
Ring: approx. 30 mm diam. (interior),
approx. 60 mm diam. (exterior)

P-1000993

Additionally required:

P-1000976 Transformer Core D

P-1000978 Pair of Pole Pieces

P-1000989 Coil with 1200 Turns (2x)

P-1003312 DC-Power Supply 0 – 20 V, 0 – 5 A (230 V, 50/60 Hz)
or

P-1003311 DC-Power Supply 0 – 20 V, 0 – 5 A (115 V, 50/60 Hz)

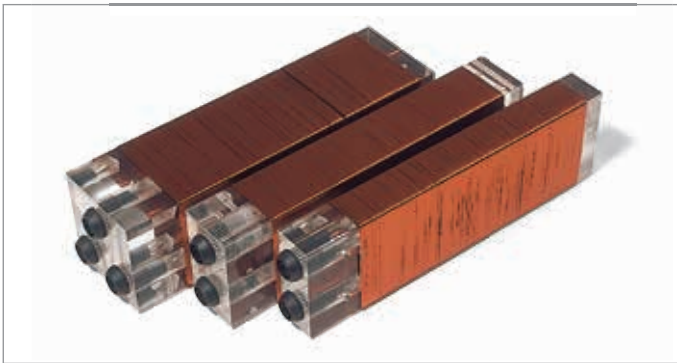

Set of 3 Induction Coils

Coils for experiments on induction in combination with the 120 mm diameter field coil (P-1000592) and for experiments on resonant electric circuits. The coils are only designed for safety extra low voltage (SELV). The spools are made of transparent acrylic plastic.

Connection: 4 mm safety sockets

Coil length: 170 mm

Coil 1

Number of turns: 300 with taps at 100 and 200 turns

Coil cross section: 50x50 mm²

Coil 2

Number of turns: 300

Coil cross section: 50x30 mm²

Coil 3

Number of turns: 300

Coil cross section: 50x20 mm²

P-1000590

Additionally recommended:

P-1000592 Field Coil 120 mm diam.

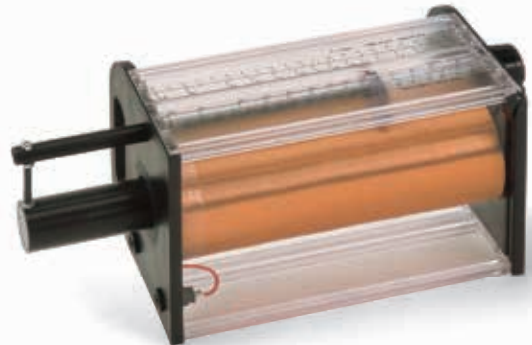

Variable Inductance Coil

Coils for measuring inductance and self-inductance of a current-carrying coil depending on the insertion of an iron core and for investigating AC circuits. Coil of copper wire in a shock-resistant plastic casing with lifting handles. A coated iron core is mounted on a worm screw for moving in and out of the coil. With printed scale in cm for reading the length of core inserted into the coil.

Number of windings: 3000

Max. permissible voltage: 30 V AC, 60 V DC

Max. permissible current: 2 A

Inductance at 1 A: approx. 0.15 – 1.4 H, continuously adjustable

Resistance: 12.5 Ω

Terminals: 4 mm safety plugs

Dimensions: approx. 265x145x130 mm³

Weight: approx. 6.2 kg

P-1003194

Lenz's Law Copper Tube

Handy demonstration apparatus for illustrating Lenz's law and induction of eddy currents. A small steel cylinder and a magnet of the same weight fall at different speeds through a copper tube because the motion of the magnet causes eddy currents to be induced, resulting in a magnetic field which slows the fall of the magnet. Includes 2 plastic caps so that the tube can be used as a container.

Length: approx. 320 mm
 Diameter: approx. 15 mm

P-1009716



P-1009716

Lenz's Law Apparatus

Instrument for demonstrating Lenz's Law qualitatively by bringing a magnet close to it. One closed and one open conductor loop, with point bearing on base.

Length: approx. 195 mm
 Height: approx. 110 mm

P-1009959



P-1009959

Additionally required:

P-1003112 Cylindrical Bar Magnet 200x10

Experiment Motor with Gearbox

Experiment motor for universal use in experiments on rotational motion, e.g. for experiments using Watt's governor (P-1009695). Can also be used as a generator in conjunction with the included hand crank. Robust clockwise and counter-clockwise rotating IDC motor with epicyclic gearbox and quick-action chuck in a tough anodized aluminum casing with removable and adjustable stainless steel stand rod. Speed of rotation is adjusted by altering the supply voltage. Adjustable torque. Includes 3 belt pulleys of different diameters on a mounting axle.

Speed without load: approx. 650 rpm at 18 V
 Speed sensitivity: approx. 36 rpm per V
 Span of chuck: 0.8 - 10 mm
 Pulleys: 10 mm diam., 20 mm diam., 40 mm diam.
 Axle: 10 mm diam.
 Drive belt: 130 mm diam. x 4 mm
 Nominal voltage: 1.5 - 18 V DC
 Connection: via 4 mm safety sockets
 Dimensions: approx. 210x110x70 mm³
 Mass: approx. 1.2 kg

Contents:

Experiment motor
 Stand rod with knurled screws
 Hand crank
 Pulleys
 Drive belt
P-1021806



P-1021806

Additionally required:

P-1003312 DC Power Supply 0 – 20 V, 5 A (230 V, 50/60 Hz)

or

P-1003311 DC Power Supply 0 – 20 V, 5 A (115 V, 50/60 Hz)

Additionally recommended:

P-1003331 Digital Stroboscope (230 V, 50/60 Hz)



Experiment Topics:

- Voltage transformation
- Transformer under load
- Current transformation
- Autotransformer
- Leakage field experiments
- Induction oven
- Point welding
- Fusing experiments
- High voltage experiment

P-1000976
P-1000987
P-1000986
P-1000985



P-1000987



UE3040500
PDF online

P-1000988

P-1000990

P-1000989



Transformer Core D

U shaped core made of high grade laminated transformer plates, with removable yoke. Provided with two clips for securing the yoke or attaching special pole shoes with drilled holes (P-1000978).

Cross-section of core: 40x40 mm²
U-core: approx. 150x130 mm²
Length of yoke: approx. 150 mm
Weight: approx. 6 kg

P-1000976

High Voltage Coil D including 2 Horn Shaped Electrodes

Secondary coil for transformer core D (P-1000976), generating high voltages which can cause spark discharges between two shielded horn electrodes. Covered with impact resistant plastic, safe to touch.

Number of turns: 24000
Open-circuit voltage: approx. 9200 V
Resistance: 10 kΩ
Max. current: 0.02 A
Inductance: 28 H

P-1000991

Additionally required:

P-1000976 Transformer Core D

P-1000987 Mains Coil D with Connecting Lead (230 V, 50/60 Hz)
or

P-1000986 Mains Coil D with Connecting Lead (115 V, 50/60 Hz)

Primary or Secondary Coils for Transformer Core D

Coils, covered with impact resistant plastic so that they are safe to touch, for use as primary or secondary coils in combination with transformer core D (P-1000976). With safety connection sockets. As secondary coils these can output either low or high voltage, depending on the primary voltage, and therefore they cannot be used in student experiments.

	P-1000988	P-1000989	P-1000990
Number of turns	600	1200	6000
Taps	200/600	400/1200	2000/6000
Resistance	3 Ω	12 Ω	300 Ω
Max. current	2.2 A	1.2 A	0.2 A
Inductance	15 mH	60 mH	1,5 H

Low Voltage Coil D

Secondary coil for use with a transformer core D (P-1000976) to generate low voltages up to 24 V. With five tapping points. Covered by impact resistant plastic, safe to touch.

Terminals: Safety sockets
Number of turns: 72
Taps: 6/ 30/ 54/ 66/ 72
Resistance: 0,1 Ω
Max. current: 12 A
Inductance: 0.23 mH

P-1000985

Additionally required:

P-1000976 Transformer Core D

P-1000987 Mains Coil D with Connecting Lead (230 V, 50/60 Hz)
or

P-1000986 Mains Coil D with Connecting Lead (115 V, 50/60 Hz)

Mains Coil D with Connecting Lead

Coil that is safe to touch with mains connecting lead for use as primary coil in combination with the transformer core D (P-1000976). Covered by impact resistant plastic, safe to touch.

High Current Coil D for Nail Fusing Experiment

Secondary coil for use with the transformer core D (P-1000976) to generate a large current sufficient to melt nails. Covered by impact resistant plastic.

Number of turns: 6
Resistance: 3 mΩ
Max. current: 60 A
Inductance: 0.25 mH

P-1000984



	P-1000987	P-1000986
Description	Mains Coil D with Connecting Lead (230 V, 50/60 Hz)	Mains Coil D with Connecting Lead (115 V, 50/60 Hz)
Number of turns	600	300
Resistance	3 Ω	0.75 Ω
Max. current	2.2 A	4.4 A
Inductance	15 mH	7.5 mH



Thomson's ring experiment

Coil D, 900 Turns

Coil with 900 turns and thermal overload protection. For generating powerful magnetic fields in conjunction with the U-core (P-1000979).

Number of turns: 900
 Inductance: approx. 34 mH
 Resistance: approx. 4.8 Ω (at room temperature)
 approx. 6.0 Ω (at maximum amperage)

Maximum permissible amperage: 5 A (for approx. 7 minutes)

Waiting time for reactivation after thermal overload: approx. 10 minutes
 Weight: approx. 1.6 kg

P-1012859



Metal Ring

Metal ring for performing Thomson's ring experiment in conjunction with the mains coil (P-1000987 resp. P-1000986) and the transformer core D (P-1000976). First the metal ring is fitted around one stem of a U core and allowed to rest on the mains coil. The stem of the U core is extended by the yoke positioned vertically on top of it. When the mains coil is switched on the ring jumps into the air.

Diameter: 55 mm

P-1000992

Additionally required:

P-1000976 Transformer Core D

P-1000987 Mains Coil D with Connecting Lead (230 V, 50/60 Hz)

or

P-1000986 Mains Coil D with Connecting Lead (115 V, 50/60 Hz)

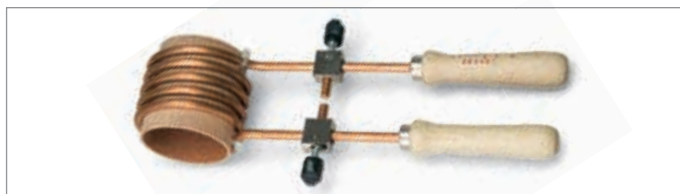

High Current Coil with Five Turns

Secondary coil for transformer core D (P-1000976), generating high voltages which can be used for spot-welding of metal sheets up to 2 mm thick.

Number of turns: 5
 Short-circuit current: approx. 260 A
 Coil diameter: 57 mm
 Weight: approx. 650 g

P-1000981

Additionally required:

P-1000982 Set of Metal Strips

P-1000976 Transformer Core D

P-1000987 Mains Coil D with Connecting Lead (230 V, 50/60 Hz)

or

P-1000986 Mains Coil D with Connecting Lead (115 V, 50/60 Hz)

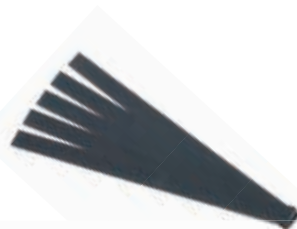

Set of Metal Strips

Five metal strips used to demonstrate spot welding techniques in conjunction with a coil with 5 turns (P-1000981).

Dimensions: 120x10 mm²

P-1000982



Set of 20 Nails for Nail Fusing Experiment

20 nails for experiments involving fusing using high current coil (P-1000984).

P-1000983



Fusion Ring

Circular copper channel with insulated handle for demonstrating the principle of induction melting, when used as a secondary coil with the transformer core D (P-1000976).

Max. current: approx. 1300 A
 Internal diameter: approx. 57 mm
 Weight: approx. 80 g

P-1000980

Suitable melting materials:

Wood's Alloy, Tin

Additionally required:

P-1000976 Transformer Core D

P-1000987 Mains Coil D with Connecting Lead (230 V, 50/60 Hz)

or

P-1000986 Mains Coil D with Connecting Lead (115 V, 50/60 Hz)

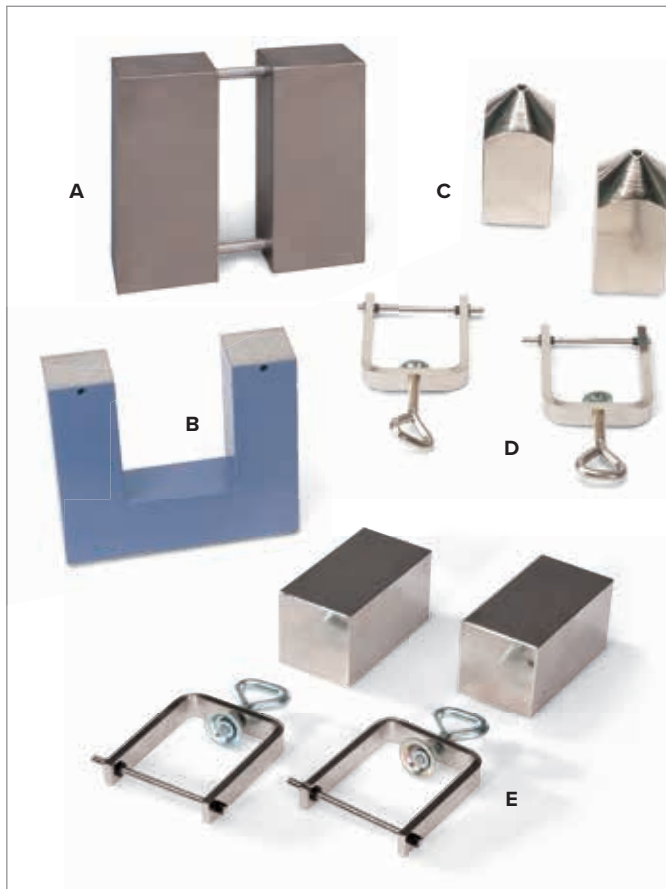

A. Pole Shoe Fitting D

Pole shoe fitting with adjustable separation for generating a uniform magnetic field on a U-shaped core D (P-1000979). Includes two 20-mm spacers, four 10 mm spacers and four 5 mm spacers.
 Dimensions: approx. 150x120x40 mm³
 Weight: approx. 5.7 kg
P-1008525

B. U Core D

U shaped transformer core D (P-1000976).
P-1000979

C. Pair of Pole Shoes D

Pair of pole shoes with conical ends for generating a highly non uniform magnetic field when fitted onto the U core D (P-1000979). Provided with holes for optical experiments in a magnetic field.
 Pole shoe: approx. 40x40 mm²
 Weight: approx. 1.7 kg
P-1000978

D. Pair of Clamps D

Pair of clamps from the transformer core D (P-1000976).
P-1000977

E. Pair of Pole Shoes and Clamping Brackets D for Hall Effect

Pair of pole pieces for experiments on the semiconductor Hall effect. Including clamping brackets for mounting on the U-core D (P-1000979).
 Pole shoe dimensions: 40x40x75 mm³
 Total weight: approx. 2 kg
P-1009935

Experiment Topics:

- Voltage transformation
- Transformer under load
- Current transformation
- Autotransformer
- Leakage field experiments
- Fusing experiments



Transformer Coils S

Impact resistant plastic covered coils, safe to touch, for assembling a transformer in conjunction with the transformer core S (P-1001004).
 Maximum voltage: 50 V (safety extra-low voltage)
 Terminals: 4 mm safety sockets
 Opening for iron cores: approx. 20x20 mm²

Art. No.	Number of turns	Max. current	Inductance
P-1001000	600	800 mA	approx. 6 mH
P-1001001	800	600 mA	approx. 10 mH
P-1001002	1200	400 mA	approx. 25 mH
P-1001003	2400	200 mA	approx. 100 mH



Transformer Core S

U-core with removable yoke made of high quality transformer laminate.
 Core cross section: approx. 20x20 mm
 U-core: approx. 70x70 mm
 Length of yoke: approx. 70 mm
P-1001004

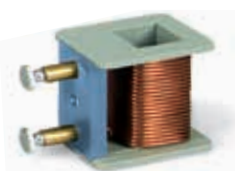

High Current Coil S

Secondary coil for transformer core S (P-1001004) for generating high current output.
 No. of windings: 22
 Max. Current: 10 A
P-1000999

Experiment Topics:

- Hertzian waves (high frequency electromagnetic waves)
- Absorption and transmission
- Corona discharge
- Spark discharge
- Wireless transmission of energy to a fluorescent lamp
- Standing waves on a Tesla coil

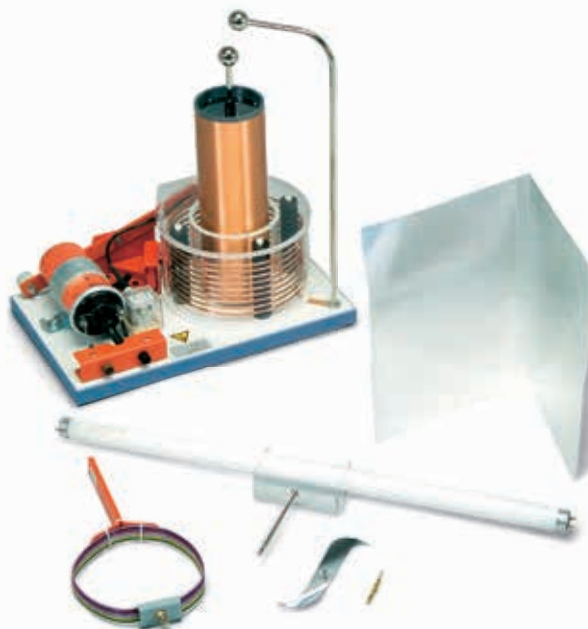

Tesla Transformer

Classic Tesla transformer for the generation of a safe high frequency high voltage starting from approx. 100 kV. The well-conceived, open configuration of all components facilitating demonstration of both design and function. The apparatus is rendered shock proof on account of its extra low voltage operation.

No. of turns in the primary coil:	2 – 10
No. of turns in the secondary coil:	1150
Primary voltage:	20 V AC
Secondary voltage:	>100 kV
Transformer:	approx. 330x200x120 mm ³
Secondary coils:	approx. 240 mm x 75 mm diam.
Weight:	approx. 3 kg

Contents:

- 1 Tesla transformer, basic apparatus
- 1 Hand coil
- 1 Secondary coil
- 1 Spherical electrode, short
- 1 Spherical electrode, long
- 1 Needle electrode with spray wheel
- 1 Fluorescent tube
- 1 Reflector

P-1000966

Additionally required:

P-1003593 AC/DC Power Supply 0 – 30 V, 6 A (230 V, 50/60 Hz)
or
P-1008692 AC/DC Power Supply 0 – 30 V, 6 A (115 V, 50/60 Hz)

Additionally recommended:

P-1000967 Additional Coil for Tesla Transformer



Additional Coil for Tesla Transformer

Additional secondary coil for Tesla transformer (P-1000966).
Dimensions: approx. 240 mm x 75 mm diam.
P-1000967



AC/DC Power Supply, 0 – 30 V, 0 – 6 A

Combined power supply with separate AC and DC outputs plus separate displays of output voltage and current. The DC output can be used as a voltage source or current source and can be set to any value within its range. The AC output features current limiting and is electronically protected against overload.

DC voltage:	0 – 30 V
DC current:	0 – 6 A
AC voltage:	0 – 30 V
AC current:	max. 6 A
Dimensions:	approx. 380x140x300 mm ³
Weight:	approx. 12 kg

AC/DC Power Supply, 0 – 30 V, 0 – 6 A (230 V, 50/60 Hz) **P-1003593**

AC/DC Power Supply, 0 – 30 V, 0 – 6 A (115 V, 50/60 Hz) **P-1008692**

Important Note:

Equipment used in training, teaching and research establishments which are designed for the investigation of electromagnetic phenomena is permitted to exceed the limits for interference emissions specified in the EMC directive. The interference generated by this apparatus is in excess of the permitted limits for interference emission according to the applicable EMC standards and could adversely affect the functionality of other electronic equipment in the building and its environment. Users are responsible for the reduction and avoidance of such adverse effects and are expected to take the necessary precautions if any interference should occur which causes problems.

Experiment Topics:

- Thermionic emission of electrons
- Linear propagation of electrons in field free spaces
- Deflection in magnetic and electric fields
- Determination of the polarity of electron charges
- Determination of specific charge e/m
- Inelastic electron collisions
- Luminescence
- Wave and particle nature of electrons



TELTRON® Electron Tubes D

Known throughout the world, tried and trusted over many years: Electron tubes with thermionic cathodes for experimental investigations of the properties of the free electron.

- Thermionic emission of electrons
- Linear propagation of electrons in field free spaces
- Deflection in magnetic and electric fields
- Determination of the polarity of electron charges
- Determination of specific charge e/m
- Inelastic electron collisions
- Luminescence
- Wave and particle nature of electrons

There is no need to take precautions against ionising radiation, since it is not necessary to use a high voltage of more than 5 kV to operate the tubes.

Electron Diffraction Tube D

Highly evacuated electron tube for demonstrating the wave nature of electrons through the observation of interference caused by passage of electrons through a polycrystalline graphite lattice (Debye-Scherrer diffraction) and rendered visible on a fluorescent screen. Also intended for determining the wavelength as a function of the anode voltage from the radii of the diffraction rings and the lattice plane spacing of graphite, as well as confirming de Broglie's hypothesis.

Filament voltage: 6.3 V AC
Max. anode voltage: 5000 V
Anode current: approx. 0.1 mA at 4000 V
Lattice constant of graphite: $d_{10} = 0.213$ nm, $d_{11} = 0.123$ nm

P-1013885

Additionally required:

P-1008507 Tube Holder D

P-1002847 Set of Leads for Electron Tube Experiments

P-1003310 High Voltage Power Supply, 5 kV (230 V, 50/60 Hz)

or

P-1003309 High Voltage Power Supply, 5 kV (115 V, 50/60 Hz)

Additionally recommended:

P-1009960 Three-Pole Protective Adaptor

Note:

When using just one high-voltage power supply, the anode voltage and capacitor voltage cannot be selected independently of one another.

Recording in a darkened room with 3 kV and 4,5 kV.

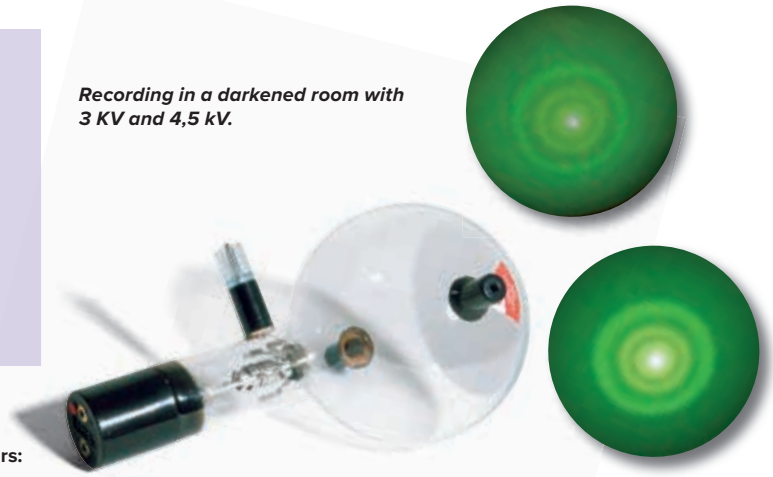

Electron Deflection Tube D

Highly evacuated electron tube with focusing electron gun and fluorescent screen inclined relative to the beam axis, so that the path of the beam can be seen and the effects of electric and magnetic fields can be studied. The electron beam can be deflected electrically in the electric field of the built-in plate capacitor, and magnetically by using the Helmholtz pair of coils D (P-1000644). By adjusting the electric field so that it cancels the magnetic deflection, it is possible to determine the specific charge e/m and the velocity of the electrons.

Filament voltage: 6.3 V AC
Max. anode voltage: 5000 V
Anode current: approx. 0.1 mA at 4000 V
Max. capacitor voltage: 5000 V
Fluorescent screen: approx. 90x60 mm²
Glass bulb: approx. 130 mm diam.
Total length: approx. 260 mm

P-1000651

Additionally required:

P-1008507 Tube Holder D

P-1002847 Set of Leads for Electron Tube Experiments

P-1000644 Helmholtz Pair of Coils D

P-1003310 High Voltage Power Supply, 5 kV (230 V, 50/60 Hz) (2x)

P-1003312 DC-Power Supply 0 – 20 V, 0 – 5 A (230 V, 50/60 Hz)

or

P-1003309 High Voltage Power Supply, 5 kV (115 V, 50/60 Hz) (2x)

P-1003311 DC-Power Supply 0 – 20 V, 0 – 5 A (115 V, 50/60 Hz)

Additionally recommended:

P-1009961 Two-Pole Protective Adaptor





Perrin Tube D

Highly evacuated electron tube with focusing electron gun, fluorescent screen, and Faraday cage positioned on one side. For demonstrating the negative polarity of electrons and estimating the specific electron charge (charge-to-mass ratio) e/m by magnetic deflection into the Faraday cage, which is connected to an electroscopes (P-1003048). It is also possible to investigate the deflection of electrons by two magnetic fields at right-angles to each other and to demonstrate the effects, for example by generating Lissajou figures.

Filament voltage:	6.3 V AC
Max. anode voltage:	5000 V
Anode current:	approx. 0.1 mA at 4000 V
Beam current:	4 μ A at 4000V
Glass bulb:	approx. 130 mm diam.
Luminescent screen:	85 mm diam.
Total length:	approx. 260 mm

P-1000650

Additionally required:

- P-1008507 Tube Holder D
- P-1002847 Set of Leads for Electron Tube Experiments
- P-1000644 Helmholtz Pair of Coils D
- P-1003310 High Voltage Power Supply, 5 kV (230 V, 50/60 Hz)
- P-1003312 DC-Power Supply 0 – 20 V, 0 – 5 A (230 V, 50/60 Hz)
- or
- P-1003309 High Voltage Power Supply, 5 kV (115 V, 50/60 Hz)
- P-1003311 DC-Power Supply 0 – 20 V, 0 – 5 A (115 V, 50/60 Hz)

Additionally recommended:

- P-1003048 Electroscopes
- P-1000645 Auxiliary Coil
- P-1009961 Two-Pole Protective Adaptor

Luminescence Tube D

Highly evacuated electron tube with divergent electron gun and three fluorescent strips in red, green and blue. For demonstrating stimulated light emission during and after electron bombardment.

Filament voltage:	6.3 V AC
Max. anode voltage:	5000 V
Anode current:	approx. 0.1 mA at 4000 V
Glass bulb:	approx. 130 mm diam.
Total length:	approx. 260 mm

P-1000648

Additionally required:

- P-1008507 Tube Holder D
- P-1002847 Set of Leads for Electron Tube Experiments
- P-1003310 High Voltage Power Supply, 5 kV (230 V, 50/60 Hz)
- or
- P-1003309 High Voltage Power Supply, 5 kV (115 V, 50/60 Hz)

Additionally recommended:

- P-1009961 Two-Pole Protective Adaptor



Maltese-Cross Tube D

Highly evacuated electron tube with divergent electron gun, fluorescent screen and Maltese cross. For demonstrating the straight line propagation of electrons in the absence of any electric or magnetic field by projecting the shadow of a Maltese cross onto the fluorescent screen and for introducing students to electron optics.

Filament voltage:	6.3 V AC
Max. anode voltage:	5000 V
Anode current:	approx. 0.1 mA at 4000 V
Glass bulb:	approx. 130 mm diam.
Luminescent screen:	85 mm diam.
Total length:	approx. 260 mm

P-1000649

Additionally required:

- P-1008507 Tube Holder D
- P-1002847 Set of Leads for Electron Tube Experiments
- P-1003310 High Voltage Power Supply, 5 kV (230 V, 50/60 Hz)
- or
- P-1003309 High Voltage Power Supply, 5 kV (115 V, 50/60 Hz)

Additionally recommended:

- P-1009961 Two-Pole Protective Adaptor
- P-1000644 Helmholtz Pair of Coils D
- P-1003312 DC-Power Supply 0 – 20 V, 0 – 5 A (230 V, 50/60 Hz)
- or
- P-1003311 DC-Power Supply 0 – 20 V, 0 – 5 A (115 V, 50/60 Hz)



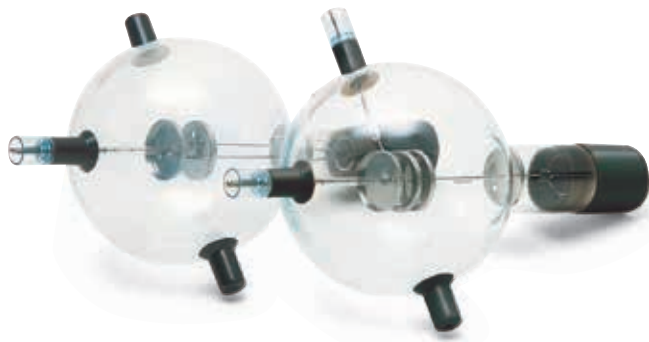

Triode D

Highly evacuated electron tube with thermionic cathode, control grid and anode for quantitative investigation of controllable high vacuum tubes, plotting the characteristics of a triode, demonstrating the negative polarity of the electron charge, studying the practical applications of a triode as an amplifier and generating undamped oscillations in LC circuits.

Max. heater voltage: 7.5 V AC/DC
 Max. anode voltage: 500 V
 Anode current: approx. 2 mA at 200 V anode voltage
 Glass bulb: approx. 130 mm diam.
 Total length: approx. 260 mm

P-1000647

Additionally required:

P-1008507 Tube Holder D
P-1002847 Set of Leads for Electron Tube Experiments
P-1013527 Analogue Multimeter ESCOLA 100
P-1003308 DC Power Supply, 0 – 500 V (230 V, 50/60 Hz)
 or
P-1003307 DC Power Supply, 0 – 500 V (115 V, 50/60 Hz)

Additionally recommended:

P-1009961 Two-Pole Protective Adaptor

Diode D

Highly evacuated electron tube with thermionic cathode and anode for investigating the thermoelectric effect (Edison effect) and measuring the emission current as a function of the heating power applied to the cathode. Also for plotting diode characteristics and for demonstrating the rectifying effect of a diode.

Max. heater voltage: 7.5 V AC/DC
 Max. anode voltage: 500 V
 Anode current: approx. 2 mA at 200 V Anode voltage
 Glass bulb: approx. 130 mm diam.
 Total length: approx. 260 mm

P-1000646



Gas Triode D

Electron tube filled with low pressure helium gas, with thermionic cathode, control grid, and anode for quantitative investigations of the typical properties of a gas-filled triode, recording the $I_A - U_A$ characteristics of a thyatron, observing independent and dependent discharges as well as discontinuous energy release of He atoms during inelastic collisions with free electrons.

Max. heater voltage: 7.5 V AC/DC
 Max. anode voltage: 500 V
 Anode current: approx. 10 mA at 200 V anode voltage
 Glass bulb: approx. 130 mm diam.
 Total length: approx. 260 mm

P-1000653

Additionally required:

P-1008507 Tube Holder D
P-1002847 Set of Leads for Electron Tube Experiments
P-1013527 Analogue Multimeter ESCOLA 100
P-1003308 DC Power Supply, 0 – 500 V (230 V, 50/60 Hz)
 or
P-1003307 DC Power Supply, 0 – 500 V (115 V, 50/60 Hz)

Additionally recommended:

P-1009961 Two-Pole Protective Adaptor

Additionally required:

P-1008507 Tube Holder D
P-1002847 Set of Leads for Electron Tube Experiments
P-1013527 Analogue Multimeter ESCOLA 100
P-1003308 DC Power Supply, 0 – 500 V (230 V, 50/60 Hz)
 or
P-1003307 DC Power Supply, 0 – 500 V (115 V, 50/60 Hz)

Additionally recommended:

P-1009961 Two-Pole Protective Adaptor



		P-1000646	P-1000647	P-1000653
P-1008507	Tube Holder D	Diode D	Triode D	Gas Triode D
P-1002847	Set of Leads for Electron Tube Experiments	required	required	required
P-1003308 or P-1003307	Power Supply, 500 V DC	required	required	required
P-1003310 or P-1003309	High Voltage Power Supply, 5 kV	–	–	–
P-1000644	Helmholtz Pair of Coils D	–	–	–
P-1003312 or P-1003311	DC-Power Supply 20 V	–	–	–
P-1013527	Analogue Multimeter ESCOLA 100	required	required	required
P-1009961	Two-Pole Protective Adaptor	recommended	recommended	recommended
P-1009960	Three-Pole Protective Adaptor	–	–	–
P-1000645	Auxiliary Coil	–	–	–
P-1003048	Electroscope	–	–	–

Dual Beam Tube D

Part evacuated electron tube, filled with neon at low pressure, with tangential and axial electron gun. For determining specific charge e/m from the diameter of the filament beam in the case of tangential bombardment and a perpendicularly aligned magnetic field, and observing spiral paths of electrons in the case of axial bombardment and a co-axial magnetic field.

The electron paths are rendered visible in the form of fine luminescent beams through impact excitation of the neon atoms.

- Max. filament voltage: 7.5 V
- Anode voltage: approx. 150 V DC
- Max. anode current: < 30 mA
- Max. deflection voltage: 50 V DC
- Glass bulb: approx. 130 mm diam.
- Total length: approx. 260 mm

P-1000654

Additionally required:

P-1008507 Tube Holder D

P-1002847 Set of Leads for Electron Tube Experiments

P-1000644 Helmholtz Pair of Coils D

P-1003308 DC Power Supply, 0 – 500 V (230 V, 50/60 Hz)

or

P-1003307 DC Power Supply, 0 – 500 V (115 V, 50/60 Hz)

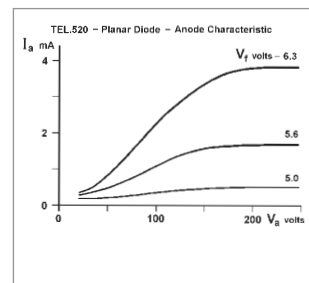
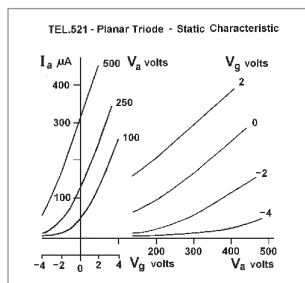
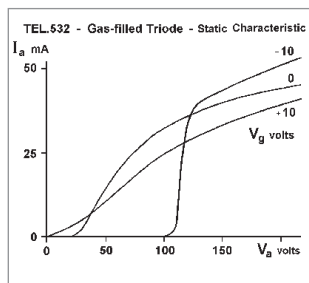
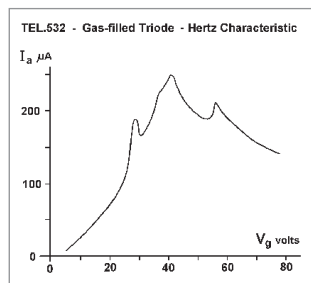
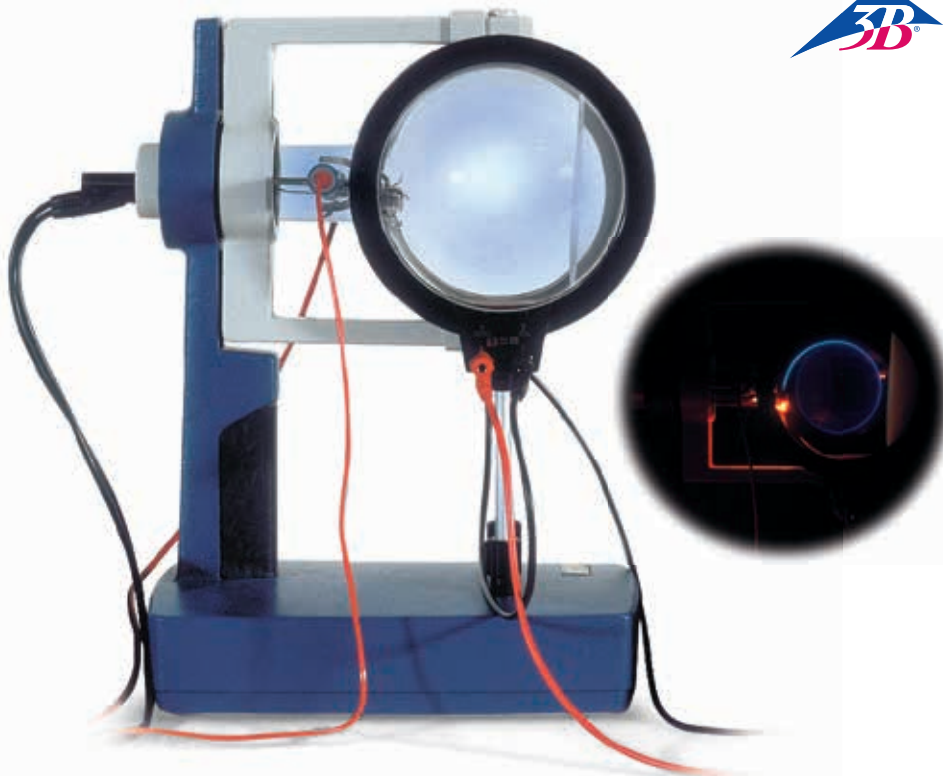

P-1000653:

Electron collision excitation in Helium as a function of the acceleration voltage U_A

P-1000653:

Anode current I_A as a function of the anode voltage U_A at different grid voltages U_G

P-1000647:

Anode current I_A as a function of the grid voltage U_G and as a function of the anode voltage U_A at different grid voltage U_G

P-1000646:

Anode current I_A as a function of the anode voltage U_A

P-1000654	P-1000648	P-1000649	P-1000650	P-1000651	P-1013885
Dual Beam Tube D	Luminescence Tube D	Maltese Cross Tube D	Perrin Tube D	Electron Deflection Tube D	Electron Diffraction Tube D
required	required	required	required	required	required
required	required	required	required	required	required
required	–	–	–	–	–
–	required	required	required	2x required	required
required	–	recommended	required	required	–
–	–	recommended	required	required	–
–	–	–	–	–	–
–	recommended	recommended	recommended	recommended	–
–	–	–	–	–	recommended
–	–	–	recommended	–	–
–	–	–	recommended	–	–



Tube Holder D

Tube holder made of robust plastic for holding electron tubes of the D series and the optical equivalent (P-1000656). With 360° rotating clamp made of heat-resistant plastic and two holes for fixing the Helmholtz coil pair D (P-1000644).

On rubber feet to prevent slipping.

Dimensions: approx. 230x175x320 mm³

Weight: approx. 1.5 kg

P-1008507

Auxiliary Coil

Extra coil for generating an additional magnetic field in a Perrin tube, for example, to demonstrate the principle of an oscilloscope and for generating Lissajou's figures.

Number of turns: 1000

DC resistance: approx. 7 Ω

Load rating: max. 2 A

Connections: 4 mm jacks

Dimensions: approx. 33 mm x 80 mm diam.

P-1000645



Protective Adaptor, 2-Pole

Adaptor for electron tubes D for connection of the heater voltage via safety experiment leads. Includes internal protective circuitry to protect the heating filament against excess voltage. Dimensions match the two-pole connector for the tubes.

P-1009961



Protective Adaptor, 3-Pole

Adaptor for electron diffraction tube D (P-1013885) for connection of the heater voltage via safety experiment leads. Includes internal protective circuitry to protect the heating filament against excess voltage. Dimensions match the three-pole connector for the tube.

P-1009960



Helmholtz Pair of Coils D

Pair of coils for generating a uniform magnetic field perpendicular to the axis of a tube when using the tube holder D (P-1008507).

In plastic sleeve on an insulated stand rod.

Coil diameter: 136 mm

Number of turns: 320 each

Effective resistance: approx. 6.5 Ω each

Load rating: 1.5 A each

Terminals: 4 mm sockets

Rod: approx. 145 mm x 8 mm diam.

P-1000644

Additionally recommended:

P-1003312 DC-Power Supply 0 – 20 V, 0 – 5 A (230 V, 50/60 Hz)
or

P-1003311 DC-Power Supply 0 – 20 V, 0 – 5 A (115 V, 50/60 Hz)

Optical Equivalent to Debye-Scherrer Interference

Aluminium disc with ball bearing mounted optical lattice grating for illustrating the principle of Debye-Scherrer interference using visible light. The rotating lattice grating serves as a model for the polycrystalline graphite lattice in the electron diffraction tube. Includes an aperture and red and green colour filters.

Cross lattice: 20 grid points/mm, 3 mm diam.

Flywheel: 100 mm diam.

Pinhole aperture: 1 mm dia.

Aperture frame: approx. 50x50 mm²

Filter: approx. 80x100 mm²

P-1000656

Additionally recommended:

P-1008507 Tube Holder D

P-1020630 Optical Lamp

P-1003023 Convex Lens, f = 100 mm

P-1000855 Object Holder on Stem

P-1000608 Projection Screen

P-1002835 Tripod Base

P-1001046 Barrel Foot (3x)



P-1000656

Experiment Topics:

- Thermionic emission of electrons
- Linear propagation of electrons in field free spaces
- Deflection in magnetic and electric fields
- Determination of the polarity of electron charges
- Determination of specific charge e/m
- Luminescence
- Excitation spectra of noble gases
- Inelastic electron collisions
- Resolution of primary and secondary quantum numbers of atomic excitation levels
- Wave and particle nature of electrons

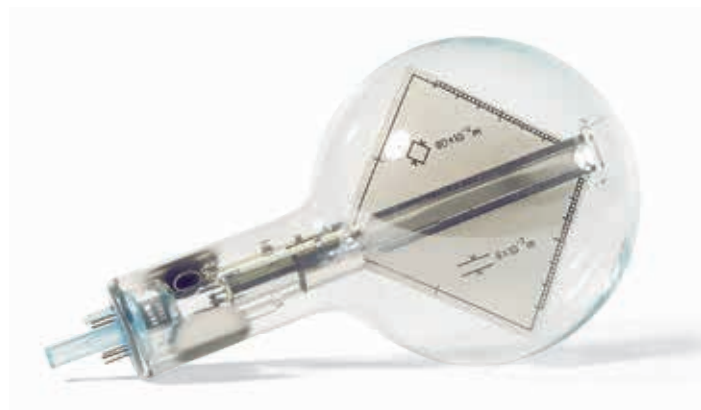

TELTRON® Electron Tubes S

Known throughout the world, tried and trusted over many years: Electron tubes with thermionic cathodes for experimental investigations of the properties of the free electron.

- Thermionic emission of electrons
- Linear propagation of electrons in field free spaces
- Deflection in magnetic and electric fields
- Determination of the polarity of electron charges
- Determination of specific charge e/m
- Luminescence
- Excitation spectra of noble gases
- Inelastic electron collisions
- Resolution of primary and secondary quantum numbers of atomic excitation levels
- Wave and particle nature of electrons

There is no need to take precautions against ionising radiation, since it is not necessary to use a high voltage of more than 5 kV to operate the tubes

Thomson Tube S

Highly evacuated electron tube with focusing electron gun and fluorescent screen inclined relative to the beam axis, so that the path of the beam can be seen and the effects of electric and magnetic fields can be studied.

The electron beam can be deflected electrically in the electric field of the built-in plate capacitor, and magnetically by using the Helmholtz coil pair S (P-1000611). By adjusting the electric field so that it cancels the magnetic deflection, it is possible to determine the specific charge e/m and the velocity of the electrons.

Filament voltage:	6.3 V AC
Max. anode voltage:	5000 V
Anode current:	approx. 0.1 mA at 4000 V
Max. Capacitor voltage:	500 V
Glass bulb:	approx. 130 mm diam.
Total length:	approx. 250 mm

P-1000617

Additionally required:

- P-1014525 Tube Holder S
- P-1002843 Set of 15 Safety Experiment Leads, 75 cm
- P-1000611 Helmholtz Pair of Coils S
- P-1003310 High Voltage Power Supply, 5 kV (230 V, 50/60 Hz)
- P-1003308 Power Supply, 500 V DC (230 V, 50/60 Hz)
- or
- P-1003309 High Voltage Power Supply, 5 kV (115 V, 50/60 Hz)
- P-1003307 Power Supply, 500 V DC (115 V, 50/60 Hz)

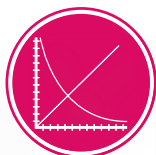

UE3070500

PDF online



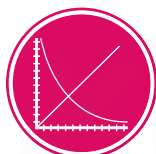

UE3070300
PDF online



UE3070400
PDF online



Maltese Cross Tube S

Highly evacuated electron tube with divergent electron gun, fluorescent screen and Maltese cross. For demonstrating the straight line propagation of electrons in the absence of any electric or magnetic field by projecting the shadow of a Maltese cross onto the fluorescent screen and for introducing students to electron optics.

Filament voltage:	6.3 V AC
Max. anode voltage:	5000 V
Anode current:	approx. 0.1 mA at 4000 V
Glass bulb:	approx. 130 mm diam.
Luminescent screen:	approx. 85 mm diam.
Total length:	approx. 250 mm

P-1000011

Additionally required:

P-1014525 Tube Holder S

P-1002843 Set of 15 Safety Patch Cords, 75 cm

P-1003310 High Voltage Power Supply, 5 kV (230 V, 50/60 Hz)

or

P-1003309 High Voltage Power Supply, 5 kV (115 V, 50/60 Hz)

Additionally recommended:

P-1000611 Helmholtz Pair of Coils S

P-1003312 DC-Power Supply 0 – 20 V, 0 – 5 A (230 V, 50/60 Hz)

or

P-1003311 DC-Power Supply 0 – 20 V, 0 – 5 A (115 V, 50/60 Hz)

Perrin Tube S

Highly evacuated electron tube with focusing electron gun, fluorescent screen, and Faraday cage positioned on one side. For demonstrating the negative polarity of electrons and estimating the specific electron charge (charge to mass ratio) e/m by magnetic deflection into the Faraday cage, which is connected to an electroscope (P-1003048). It is also possible to investigate the deflection of electrons by two alternating magnetic fields at right-angles to each other or by parallel electric and magnetic fields and to demonstrate the effects, for example by generating Lissajous figures.

Filament voltage:	6.3 V AC
Max. anode voltage:	5000 V
Anode current:	approx. 0.1 mA at 4000 V
Beam current:	4 μ A at 4000V
Glass bulb:	approx. 130 mm diam.
Luminescent screen:	approx. 85 mm diam.
Total length:	approx. 250 mm

P-1000616

Additionally required:

P-1014525 Tube Holder S

P-1002843 Set of 15 Safety Patch Cords, 75 cm

P-1000611 Helmholtz Pair of Coils S

P-1003310 High Voltage Power Supply, 5 kV (230 V, 50/60 Hz)

P-1003312 DC-Power Supply 0 – 20 V, 0 – 5 A (230 V, 50/60 Hz)

or

P-1003309 High Voltage Power Supply, 5 kV (115 V, 50/60 Hz)

P-1003311 DC-Power Supply 0 – 20 V, 0 – 5 A (115 V, 50/60 Hz)

Additionally recommended:

P-1003048 Electroscop

P-1000645 Auxiliary Coil

Luminescence Tube S

Highly evacuated electron tube with divergent electron gun and three fluorescent strips in red, green and blue. For demonstrating stimulated light emission during and after electron bombardment.

Filament voltage:	6.3 V AC
Max. anode voltage:	5000 V
Anode current:	approx. 0.1 mA at 4000 V
Glass bulb:	approx. 130 mm diam.
Total length:	approx. 250 mm

P-1000615

Additionally required:

P-1014525 Tube Holder S

P-1002843 Set of 15 Safety Patch Cords, 75 cm

P-1003310 High Voltage Power Supply, 5 kV (230 V, 50/60 Hz)

or

P-1003309 High Voltage Power Supply, 5 kV (115 V, 50/60 Hz)

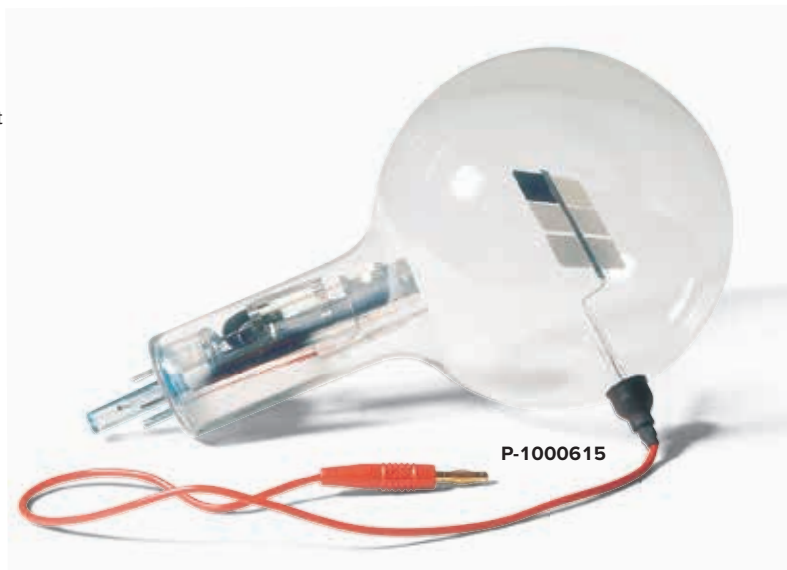

P-1000615

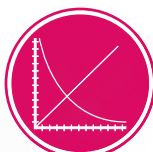

UE3070100
UE3070200
PDF online

P-1000614
P-1000618



P-1003308
P-1003307



P-1014525

P-1013527



Diode S

Highly evacuated electron tube with thermionic cathode and anode for investigating the thermoelectric effect (Edison effect) and measuring the emission current as a function of the heating power applied to the cathode. Also for plotting diode characteristics and for demonstrating the rectifying effect of a diode.

Max. heater voltage: 7.5 V AC/DC
Max. anode voltage: 500 V
Anode current: approx. 2 mA at 200 V Anode voltage
Glass bulb: approx. 130 mm diam.
Total length: approx. 250 mm

P-1000613

Additionally required:

P-1014525 Tube Holder S
P-1002843 Set of 15 Safety Patch Cords, 75 cm
P-1013527 Analogue Multimeter ESCOLA 100
P-1003308 Power Supply, 500 V DC (230 V, 50/60 Hz)
or
P-1003307 Power Supply, 500 V DC (115 V, 50/60 Hz)

Gas Triode S

Electron tube filled with low pressure helium gas resp. neon gas, with thermionic cathode, control grid, and anode for quantitative investigations of the typical properties of a gas-filled triode, recording the $I_A - U_A$ characteristics of a thyratron, observing independent and dependent discharges as well as discontinuous energy release of He or Ne atoms during inelastic collisions with free electrons.

Max. heater voltage: 7.5 V AC/DC
Max. anode voltage: 500 V
Anode current: approx. 10 mA at 200 V anode voltage
Glass bulb: approx. 130 mm diam.
Total length: approx. 250 mm

Gas Triode S with He Filling
P-1000618

Gas Triode S with Ne Filling
P-1000619

Additionally required:

P-1014525 Tube Holder S
P-1002843 Set of 15 Safety Patch Cords, 75 cm
P-1013527 Analogue Multimeter ESCOLA 100
P-1003308 Power Supply, 500 V DC (230 V, 50/60 Hz)
or
P-1003307 Power Supply, 500 V DC (115 V, 50/60 Hz)

Triode S

Highly evacuated electron tube with thermionic cathode, control grid and anode for quantitative investigation of controllable high vacuum tubes, plotting the characteristics of a triode, demonstrating the negative polarity of the electron charge, studying the practical applications of a triode as an amplifier and generating undamped oscillations in LC circuits

Max. heater voltage: 7.5 V AC/DC
Max. anode voltage: 500 V
Anode current: approx. 2 mA at 200 V anode voltage
Glass bulb: approx. 130 mm diam.
Total length: approx. 250 mm

P-1000614

Additionally required:

P-1014525 Tube Holder S
P-1002843 Set of 15 Safety Patch Cords, 75 cm
P-1013527 Analogue Multimeter ESCOLA 100
P-1003308 Power Supply, 500 V DC (230 V, 50/60 Hz)
or
P-1003307 Power Supply, 500 V DC (115 V, 50/60 Hz)



P-1000613

P-1000614
P-1000618
P-1000619

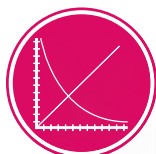

UE5010500
PDF online



Electron Diffraction Tube S

Highly evacuated electron tube for demonstrating the wave nature of electrons through the observation of interference caused by passage of electrons through a polycrystalline graphite lattice (Debye-Scherrer diffraction) and rendered visible on a fluorescent screen. Also intended for determining the wavelength as a function of the anode voltage from the radii of the diffraction rings and the lattice plane spacing of graphite, as well as confirming de Broglie's hypothesis.

Filament voltage: 6.3 V AC
 Max. anode voltage: 5000 V
 Anode current: approx. 0.1 mA at 4000 V
 Lattice constant of graphite: $d_{10} = 0.213 \text{ nm}$, $d_{11} = 0.123 \text{ nm}$

P-1013889

Additionally required:

P-1014525 Tube Holder S

P-1002843 Set of 15 Safety Experiment Leads, 75 cm

P-1003310 High Voltage Power Supply, 5 kV (230 V, 50/60 Hz)

or

P-1003309 High Voltage Power Supply, 5 kV (115 V, 50/60 Hz)

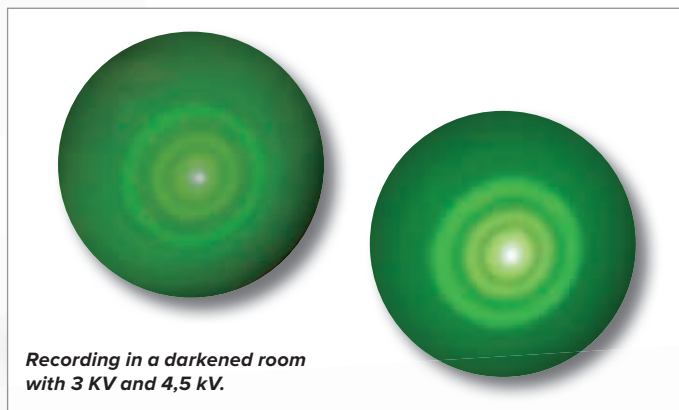

Recording in a darkened room with 3 kV and 4.5 kV.



Dual Beam Tube S

Part evacuated electron tube, filled with neon at low pressure, with tangential and axial electron gun. For determining specific charge e/m from the diameter of the filament beam in the case of tangential bombardment and a perpendicularly aligned magnetic field, and observing spiral paths of electrons in the case of axial bombardment and a co-axial magnetic field. The electron paths are rendered visible in the form of fine luminescent beams through impact excitation of the neon atoms.

Max. filament voltage: 7.5 V AC/DC
 Anode voltage: approx. 150 V DC
 Max. anode current: < 30 mA
 Max. deflection voltage: 50 V DC
 Glass bulb: approx. 130 mm diam.
 Total length: approx. 250 mm

P-1000622

Additionally required:

P-1014525 Tube Holder S

P-1002843 Set of 15 Safety Patch Cords, 75 cm

P-1000611 Helmholtz Pair of Coils S

P-1003308 Power Supply, 500 V DC (230 V, 50/60 Hz)

or

P-1003307 Power Supply, 500 V DC (115 V, 50/60 Hz)

		P-1000613	P-1000614	P-1000618	P-1000619	P-1000622
		Diode S	Triode S	Gas Triode S with He Filling	Gas Triode S with Ne Filling	Dual Beam Tube S
P-1014525	Tube Holder S	required	required	required	required	required
P-1002843	Set of 15 Safety Patch Cords, 75 cm	required	required	required	required	required
P-1002839	Experiment Lead, Safety Plug and Socket	–	–	–	–	–
P-1003308 or P-1003307	Power Supply, 500 V DC	required	required	required	required	required
P-1003310 or P-1003309	High Voltage Power Supply, 5 kV	–	–	–	–	–
P-1000611	Helmholtz Pair of Coils S	–	–	–	–	required
P-1003312 or P-1003311	DC-Power Supply, 20 V	–	–	–	–	–
P-1013527	Analogue Multimeter ESCOLA 100	required	required	required	required	–
P-1000645	Auxiliary Coil	–	–	–	–	–
P-1003048	Electroscope	–	–	–	–	–

Tube Holder S

Tube holder to support all S series electron tubes for easy and safe operation. The five pin sockets for the tube are concealed inside the tube holder. A cathode protection switch is integrated into the tube holder, to protect the heated cathode from excessive voltage. The base plate has a slot for attaching the Helmholtz pair of coils S (P-1000611).

Terminals : 4 mm safety sockets
 Dimensions: approx. 130x190x250 mm³
 Weight: approx. 570 g

P-1014525



Replacement Circuit Board for Tube Holder S

The quality of the electron beam in electron defraction tube S (P-1013889) is affected by the resistance between sockets C5 (cathode) and F4 (heating filament) on the tube. For optimum results, the resistance needs to be 390 k Ω . Tube holder S (P-1014525) is accordingly designed such that this resistance is present. Older designs feature a much smaller resistance and need to be modified in order to work with the new S-series electron deflection tube (P-1013889).

Tube holders affected: U18500, U185001, P-1000610

P-4008573

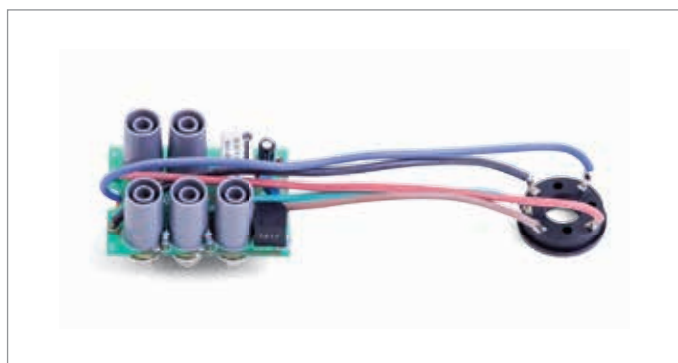

Helmholtz Pair of Coils S

Pair of coils for generating a uniform magnetic field perpendicular to the axis of a tube when using the tube holder S (P-1014525).

Number of turns: 320 each
 Coil diameter: 138 mm each
 Load rating: 1.0 A (Continuous operation) each
 1.5 A (Short-term operation)
 Effective Resistance: approx. 6,5 Ω each
 Terminals: 4 mm safety sockets

P-1000611

Additionally recommended:

P-1003312 DC-Power Supply 0 – 20 V, 0 – 5 A (230 V, 50/60 Hz)

or

P-1003311 DC-Power Supply 0 – 20 V, 0 – 5 A (115 V, 50/60 Hz)



P-1000615	P-1000011	P-1000616	P-1000617	P-1013889	P-1000624
Luminescence Tube S	Maltese Cross Tube S	Perrin Tube S	Thomson Tube S	Electron Defraction Tube S	Gas Discharge Tube S
required	required	required	required	required	required
required	required	required	required	required	–
–	–	–	–	–	2x required
–	–	–	required	–	–
required	required	required	required	required	required
–	recommended	required	required	–	–
–	recommended	required	–	–	–
–	–	–	–	–	–
–	–	recommended	–	–	–
–	–	recommended	–	–	–



Gas Discharge Tube S

Evacuatable glass tube with fluorescent screens at both ends for observation of electrical discharges in gases under reduced pressure as well as for investigation of cathode beams and canal rays, which appear at low pressure outside the discharge path. Demountable design, installation in tube holder (P-1014525). Includes a needle ventilation valve and vacuum hoses.

Length: approx. 280 mm
 Polarization voltage: ≤ 5 kV
 Discharge current: approx. 1.2 mA
 Connections: 4 mm contact pins

P-1000624

Additionally required:

P-1014525 Tube Holder S

P-1002839 Experiment Lead, Safety Plug and Socket (2x)

P-1003317 Rotary-Vane Vacuum Pump, Two-Stage

P-1003310 High Voltage Power Supply, 5 kV (230 V, 50/60 Hz)

or

P-1003309 High Voltage Power Supply, 5 kV (115 V, 50/60 Hz)

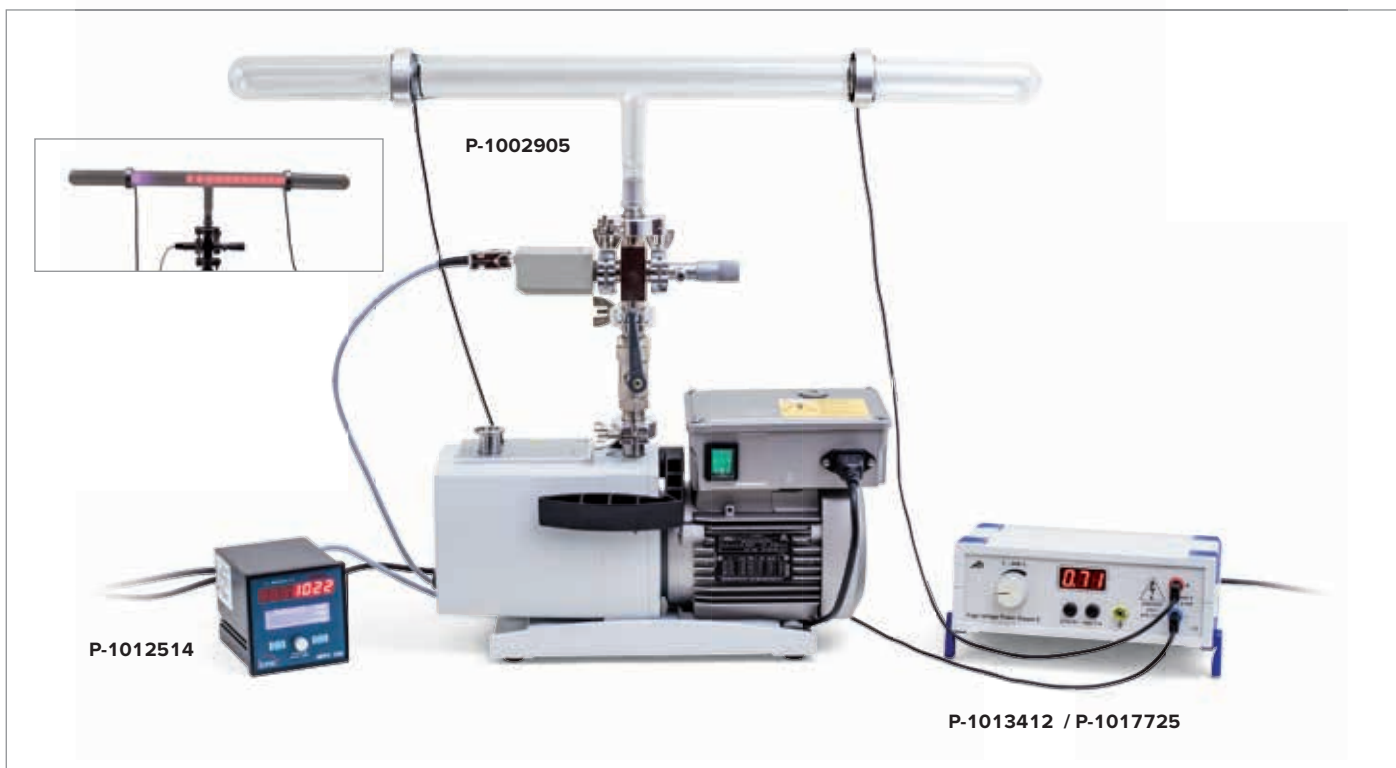

Gas Discharge Tube

Evacuatable glass tube for observation of luminous effects of electrical discharges in gases under reduced pressure. Glass tube with graded seal, disc shaped, perforated electrodes and 4 mm jacks for connecting the voltage supply.

Material: glass
 Dimensions: approx. 700 mm x 40 mm diam.
 Vacuum connection: graded seal NS 19/26

P-1002905

Additionally recommended:

P-1003310 High Voltage Power Supply E, 5 kV (230 V, 50/60 Hz)

or

P-1003309 High Voltage Power Supply E, 5 kV (115 V, 50/60 Hz)

P-1002919 Rotary Vane Pump P 4 Z

P-1012514 Pirani Vacuum Gauge

P-1002923 2-Way Ball Valve DN 16 KF

P-1002924 Crosspiece DN 16 KF

P-1002929 Adaptor Flange DN 16 – Core NS 19/26

P-1002926 Ventilation Valve DN 16 KF

P-1002930 Tension Ring DN 10/16 KF (5x)

P-1002931 KF External Centring Ring DN 10/16 KF (5x)



Experiment Topics:

- Linear propagation of electrons in a zero-field space
- Deflection of electron beams in an electrical field
- Deflection of electron beams in a magnetic field
- Magnetic lens
- Phase displacement, superimposition of magnetic fields, Lissajous figures
- Determination of an electron's specific charge
- Determination of an electron's speed

Training Oscilloscope

Electron tube mounted on a terminal base for investigating the design and operation of a cathode ray tube. The electron beam can be deflected by an electric field produced by the deflection plates integrated into the tube, and by a magnetic field from three external coils mounted on a ring. A Wehnelt cylinder is used to focus the beam. The gas filling and the fluorescent screen make it possible to observe the beam in the tube. A continuously adjustable saw-tooth generator can be used to analyse and visualize time dependent processes. The device comes with a socket and printed wiring diagram.

Anode voltage:	200 – 350 V DC
Anode current:	max. 1 mA
Filament voltage:	6 – 12 V DC
Filament current:	0.3 A
Wehnelt voltage:	0 – -50 V DC
Deflection plate dimensions:	approx. 12x20 mm ²
Plate spacing:	approx. 14 mm
Electric deflection sensitivity:	0,2 mm/V
Screen diameter:	approx. 100 mm
Tube length:	approx. 260 mm

Residual gas:	Neon
Gas pressure:	10 ⁻⁴ hPa
Sweep frequency:	10 – 200 Hz, continuously adjustable
3 deflection coils:	600 turns each, with a centre pick up
Weight:	approx. 1.6 kg

P-1000902

Additionally recommended:

P-1003308 DC Power Supply, 0 – 500 V (230 V, 50/60 Hz)

P-1009957 Function Generator FG100 (230 V, 50/60 Hz)

or

P-1003307 DC Power Supply, 0 – 500 V (115 V, 50/60 Hz)

P-1009956 Function Generator FG100 (115 V, 50/60 Hz)

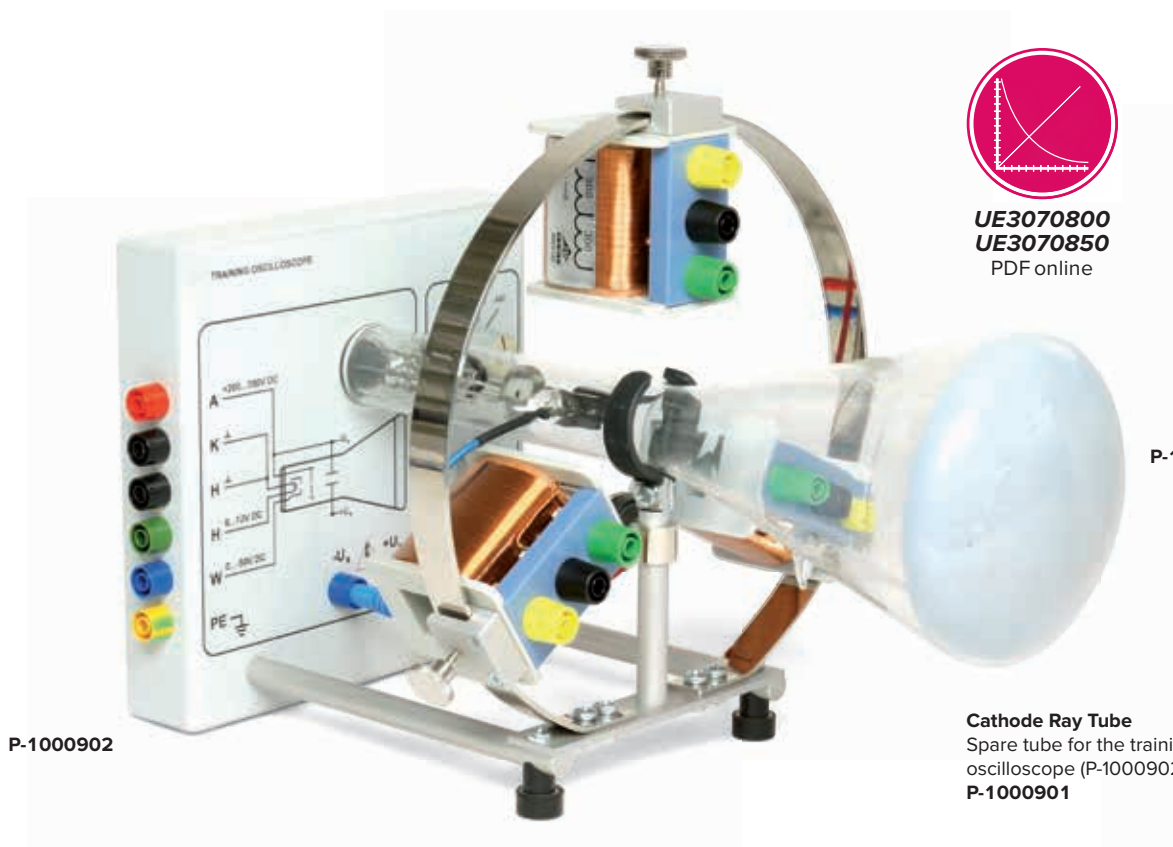

P-1000902



UE3070800
UE3070850
 PDF online

P-1000901

Cathode Ray Tube

Spare tube for the training oscilloscope (P-1000902).

P-1000901

Experiment Topics:

- Deflection of electrons in a closed circular path inside a magnetic field
- Determination of specific charge of an electron e/m

Fine Beam Tube on Connection Base R

For examining the deflection of electron beams in a uniform magnetic field using a pair of Helmholtz coils (P-1000906) and for the quantitative determination of the specific charge of the electron e/m . Glass vessel with integrated electron beam system, consisting of an indirectly heated oxide cathode, a Wehnelt cylinder and a perforated anode, in neon residual gas atmosphere with precisely set gas pressure and with integrated measurement marks for parallax-free determination of the diameter of the fine beam. Gas atoms are ionized along the electron path and produce a sharply defined, visible fluorescent beam. Tube mounted on base with colour coded connectors.

Gas filling:	Neon
Gas pressure:	1.3×10^{-5} hPa
Filament voltage:	5 – 7 V DC
Filament current:	< 150 mA
Wehnelt voltage:	0 – -50 V
Anode voltage:	200 – 300 V
Anode current:	< 0.3 mA
Circular path diameter:	20 – 120 mm
Division spacing:	approx. 20 mm
Tube diameter:	approx. 160 mm
Dimensions:	approx. 115x115x35 mm ³
Weight:	approx. 820 g

P-1019957

Additionally required:

P-1000906 Helmholtz Coils

P-1003308 Power Supply, 500 V DC (230 V, 50/60 Hz)

or

P-1003307 DC Power Supply, 0 – 500 V (115 V, 50/60 Hz)

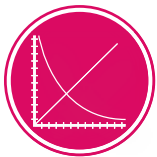
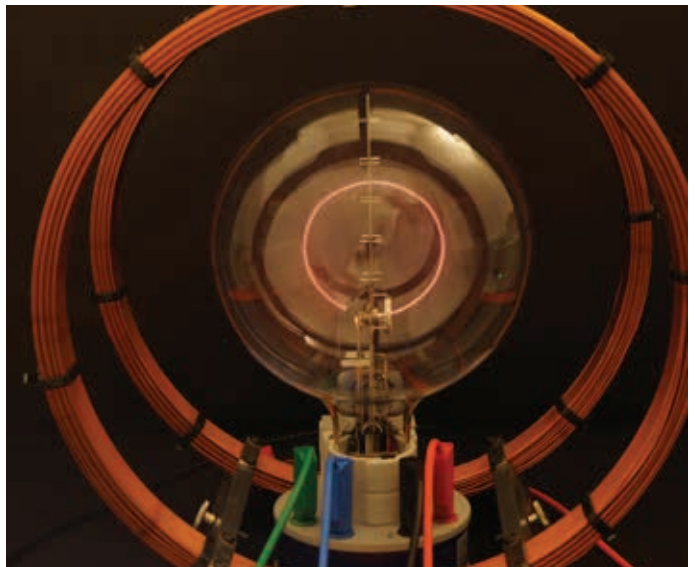
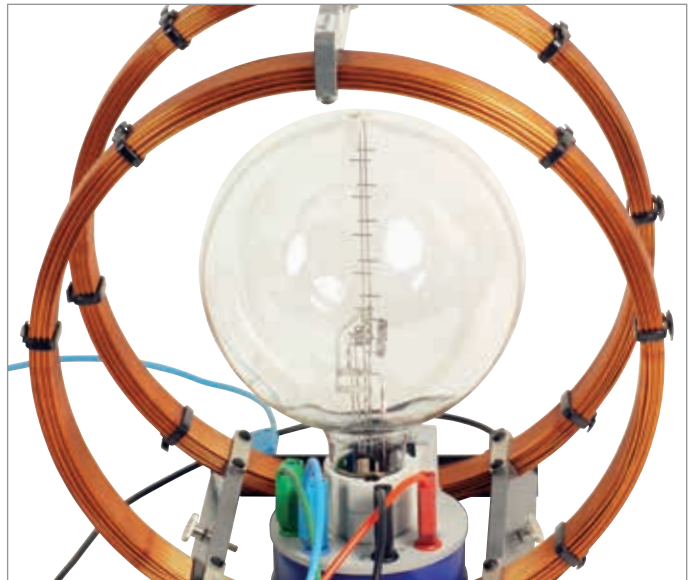

UE3070700

PDF online



Experiment Topics:

- Electron deflection in a uniform magnetic field
- Closed orbit or spiral path
- Determining an electron's specific charge e/m

Complete Fine Beam Tube System

This complete experimental system is used to determine an electron's specific charge and investigate the deflection of electron beams in a uniform magnetic field. The system comes complete with a fine-beam tube, Helmholtz coil pair for generating a uniform magnetic field, and operating unit for power supply. The fine beam tube and Helmholtz coil pair are mounted on the operating unit, the fine beam tube being rotatable around its vertical axis. The tube and coil pair are both connected internally to the operating unit without a need for external wiring. All supply voltages for the tube and the current through the Helmholtz coils are adjustable. The anode voltage and coil current are displayed digitally and can be tapped additionally as equivalent voltage values. Inside the fine beam tube, a sharply delimited electron beam is generated by a system comprising an indirectly heated oxide cathode, perforated anode and Wehnelt cylinder. Impact ionization of neon atoms creates a very bright, also sharply delimited trace of the electron path in the tube. If the tube is aligned optimally and an appropriate current flows through the Helmholtz coils, the electrons are deflected into a circular orbit, whose diameter can be easily determined when the electrons strike one of the equidistant measurement marks, causing its end to light up. Diameter, anode voltage and magnetic field are the parameters used to determine the electron's specific charge. The magnetic field can be calculated from the coil current, the geometry of the Helmholtz coil pair being known.

Fine-beam tube:

Gas filling: Neon
 Gas pressure: 1.3×10^{-5} hPa
 Bulb diameter: 165 mm
 Orbit diameter: 20 – 120 mm
 Measurement mark spacing: 20 mm

Helmholtz coil pair:

Coil diameter: approx. 300 mm
 Winding count: 124
 Magnetic field: 0 – 3.4 mT (0.75 mT/A)

Operating unit:

Coil current: 0 – 4.5 A, 3-figure digital display
 Measurement output: $1 V_B^2 / A$
 Anode voltage: 15 – 300 V, 3-figure digital display
 Measurement output: $0.01 \cdot U_A$
 Heating voltage: 5 – 7 V
 Wehnelt voltage: 0 – -50 V

General data:

Tube's rotary angle: -10° – 270°
 Supply voltage: 100 – 240 V, 50/60 Hz
 Power supply cable: EU, UK and US
 Dimensions: approx. 310x275x410 mm³
 Weight: approx. 7.5 kg

P-1013843

The complete fine-beam tube system consists of the following parts:

**Fine Beam Tube T
 P-1008505**

**Operating Unit for Fine-Beam Tube
 P-1009948**

➤ Recording in a darkened room



Spiral path



Circular path



ATOMIC AND NUCLEAR PHYSICS

PERIODENSYSTEM DER ELEMENTE PERIODIC TABLE OF THE ELEMENTS

This is a standard periodic table of elements. The top left is labeled 'PERIODENSYSTEM DER ELEMENTE' and the top right is 'PERIODIC TABLE OF THE ELEMENTS'. The table is organized into groups and periods. The main groups are labeled I through VIII. The transition elements are labeled with Roman numerals from IIIa to VIIIa. The lanthanoids and actinoids are shown as separate rows at the bottom. The table includes element symbols, atomic numbers, and names in both German and English. The periodicity is indicated by the numbers 1 through 7 on the right side.

P-1017655

Periodensystem der Elemente
Periodic System of the Elements
Système périodique des éléments
Sistema periódico de los elementos

This is a periodic table of elements where each element's cell contains a small photograph of the element. The table is organized into groups and periods. The main groups are labeled with Roman numerals from I to VIII. The transition elements are labeled with Roman numerals from IIIA to VIIIA. The lanthanoids and actinoids are shown as separate rows at the bottom. The table includes element symbols, atomic numbers, and names in four languages: German, English, French, and Spanish. The periodicity is indicated by the numbers 1 through 7 on the right side.

P-1013907

Periodic Table of the Elements, with Electron Configurations

Chart of the periodic table of the elements showing the configurations of electron shells. On strong laminated material with rods and hanging cord. Bilingual.

Dimensions: approx. 1950x1380 mm²

Languages: English and German

P-1017655

Periodic Table of the Elements, with Pictures

Chart of the periodic table of the elements with pictures of the elements. On strong laminated material with rods and hanging cord. In four languages.

Dimensions: approx. 1950x1380 mm²

Languages: English, German, French, Spanish

P-1013907

Experiment Topics:

- Millikan's experiment
- Discrete nature (quantisation) of electric charge
- Elementary electric charge
- Charged oil droplets in an electric field
- Stokes viscous drag, weight, buoyancy
- Equilibrium voltage
- Velocity of fall and velocity of rise



Advantages:

- Compact instrument with built-in measurement and display unit
- Touch-sensitive screen for simple and ergonomic operation
- Maintenance-free lighting unit for uniform lighting via two green LEDs
- Built-in pressure and temperature sensor for automatically determining the relevant parameters, temperature, viscosity and pressure

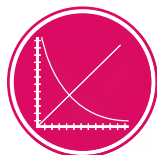

UE5010400
PDF online



Millikan's Apparatus

Compact apparatus for demonstrating the discrete nature (quantisation) of electric charge and for determining the elementary charge of an electron. Comprising an experiment chamber kit for assembly with plate capacitor and connected oil atomiser, lighting unit with two green LEDs, measuring microscope, voltage adjustment knob and switch to set the capacitor voltage, switch for starting and stopping rise and fall time measurements and a display unit with touch screen.

Measurements can be made using the floating method or the rising and falling method. Measured rise and fall times for a charged droplet of oil are displayed on the touch screen along with the configured voltage. Parameters relevant to the evaluation of the results, temperature, viscosity and pressure are also displayed. Includes plug-in power supply, 12 V AC, 1 A.

Dimensions (including measuring microscope): approx. 370x430x235 mm³

Weight (including plug-in power supply): approx. 4.3 kg

Contents:

- 1 Basic apparatus with experiment chamber and display unit
- 1 Measuring microscope
- 1 Oil atomiser
- 50 ml of oil for Millikan's apparatus
- 1 Plug-in power supply, 12 V AC, 1 A

Millikan's Apparatus (230 V, 50/60 Hz)

P-1018884

Millikan's Apparatus (115 V, 50/60 Hz)

P-1018882

Additionally recommended:

P-1021162 Moticam 1

P-1021536 Moticam Adapter Ring



Millikan device with attached Moticam

Moticam 1

Low-cost digital colour camera for connection to a PC or laptop via USB port. With the help of the adapter ring (P-1021536), the camera can be attached to the eyepiece of the Millikan device's measuring microscope. This extends the Millikan device for demonstration experiments and enables nearly effortless work. Further information on Moticam is provided on P.292.

P-1021162

Additionally required:

P-1021536 Moticam Adapter Ring

Adapter Ring Moticam (not shown)

Adapter for fitting the Moticam on the eyepiece of the Millikan device's measuring microscope.

P-1021536

Oil for Millikan's (not shown)

50 ml of oil for experiments using Millikan's apparatus.

P-1019304



Organic/Inorganic Molecule Set D

Molecule building set for assembling three-dimensional models of organic and inorganic molecules and for clarification of their spatial configurations. Many chemical compounds can be represented clearly. These include simple molecules such as hydrogen, oxygen and water, organic compounds such as ethane, ethene, ethyne, benzene, alanine, glucose, and cyclohexane and also more complex structures such as the tetrammino zinc ion or tetraphosphorous decoxide.

P-1005279

Contents:

Atoms						
14	C	black	4 wholes	tetrahedral	109°	
6	C	dark blue	5 wholes	tribipyramidal	90°, 120°	
12	H	white	1 whole	one sided		
2	H	white	1 whole	linear	180°	
16	O	red	2 wholes	angular	105°	
6	O	red	4 wholes	tetrahedral	109°	
6	N	blue	4 wholes	tetrahedral	109°	
4	N	blue	3 wholes	pyramidal	107°	
4	S	yellow	4 wholes	tetrahedral	109°	
1	S	yellow	6 wholes	octahedral	90°	
8	S	yellow	2 wholes	angular	105°	
8	Cl, (F)	green	1 wholes	one sided		
4	P	purple	4 wholes	tetrahedral	109°	
1	P	purple	5 wholes	tribipyramidal	90°, 120°	
2	P	purple	3 wholes	pyramidal	107°	
4	Na	grey	1 whole	one sided		
3	Ca, Mg	grey	2 wholes	angular	105°	
2	Al	grey	3 wholes	trigonal	120°	
4	Si, Cu	grey	4 wholes	tetrahedral	109°	
1	metal atom	grey	6 wholes	octahedral	90°	

Electron clouds

6	lone pair	light beige
6	unhybridised p-lobe	purple
6	unhybridised p-lobe	pink

Links

38	medium	light grey
12	medium	purple
36	long, flexible	grey

Organic Molecule Set S

Molecule building set for assembling three-dimensional models of organic molecules and for clarification of their spatial configurations. Many chemical compounds can be represented clearly and phenomena such as structural isomerism, optical isomerism and geometric isomerism can be illustrated. The spectrum ranges from simple molecules such as alkanes, alkenes and alkynes, alcohols, aldehydes, ketones, carboxylic acids, esters, ethers, halogenated compounds, amines, amides, cycloalkanes to biochemical molecules, amino acids, aromatic molecules and polymers.

P-1005290

Contents:

Atoms						
12	C	black	4 wholes	tetrahedral	109°	
20	H	white	1 whole	one sided		
6	O	red	2 wholes	angular	105°	
2	N	blue	4 wholes	tetrahedral	109°	
2	N	blue	3 wholes	pyramidal	107°	
1	S	yellow	4 wholes	tetrahedral	109°	
1	S	yellow	6 wholes	octahedral	90°	
4	Cl, (F)	green	1 whole	one sided		
1	P	purple	4 wholes	tetrahedral	109°	
1	Na	grey	1 whole	one sided		

Links

26	short	white
6	medium	light grey
12	long, flexible	grey

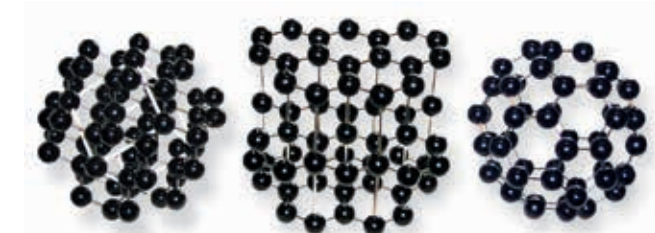

Set of 3 Carbon Configurations

Set of 3 easy-to-use models of various carbon crystal structures: diamond, graphite and fullerene, for demonstrating the fundamental differences between the structures.

Ball diameter: approx. 25 mm

Lengths of sides: approx. 150 mm

P-1012836

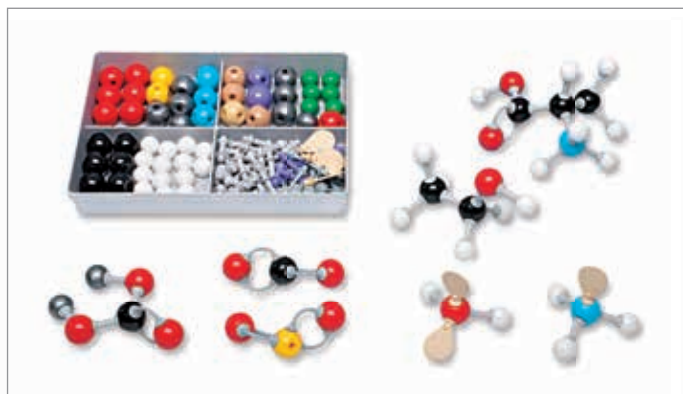

Organic/Inorganic Molecule Set S

Molecule building set for assembling three-dimensional models of organic and inorganic molecules and for clarification of their spatial configurations. Many chemical compounds can be represented clearly. These include inorganic molecules such as hydrogen, oxygen, water, acids, salts, metal oxides, and non metal oxides and also organic compounds such as ethane, ethene, ethyne, benzene, alanine, glucose, and cyclohexane.

P-1005291

Contents:

Atoms					
6	C	black	4 wholes	tetrahedral	109°
14	H	white	1 whole	one sided	
6	O	red	2 wholes	angular	105°
1	O	red	4 wholes	tetrahedral	109°
2	N	blue	4 wholes	tetrahedral	109°
1	N	blue	3 wholes	pyramidal	107°
1	S	yellow	4 wholes	tetrahedral	109°
1	S	yellow	6 wholes	octahedral	90°
6	Cl, (F)	green	1 wholes	one sided	
1	P	purple	5 wholes	tribipyramidal	90°, 120°
1	P	purple	3 wholes	pyramidal	107°
2	Na	grey	1 wholes	one sided	
2	Ca, Mg	grey	2 wholes	angular	105°
1	Be	grey	2 wholes	linear	180°
1	Al	grey	3 wholes	trigonal	120°
1	Si, Cu	grey	4 wholes	tetrahedral	109°
1	metal atom	grey	6 wholes	octahedral	90°
1	B	light beige	3 wholes	trigonal	120°
1	atom	beige	4 wholes	tetrahedral	109°
1	atom	beige	5 wholes	tribipyramidal	90°, 120°
1	atom	beige	6 wholes	octahedral	90°

Electron clouds

3	lone pair	light beige
---	-----------	-------------

Links

20	medium	light grey
5	medium	purple
12	lang flexibel	grey



Organic Molecule Set D

Molecule building set for assembling three-dimensional models of organic molecules and for clarification of their spatial configurations. Many chemical compounds can be represented clearly and phenomena such as structural isomerism, optical isomerism and geometric isomerism can be illustrated. The spectrum ranges from simple molecules such as alkanes, alkenes and alkynes, alcohols, aldehydes, ketones, carboxylic acids, esters, ethers, halogenated compounds, amines, amides, cycloalkanes to biochemical molecules, amino acids, aromatic molecules and polymers.

P-1005278

Contents:

Atoms					
24	C	black	4 wholes	tetrahedral	109°
6	C	dark grey	3 wholes	trigonal	120°
2	C	dark grey	2 wholes	linear	180°
6	C	dark blue	5 wholes	tribipyramidal	90°, 120°
40	H	white	1 whole	one sided	
12	O	red	2 wholes	angular	105°
4	N	blue	4 wholes	tetrahedral	109°
1	S	yellow	4 wholes	tetrahedral	109°
1	S	yellow	2 wholes	angular	105°
8	Cl, (F)	green	1 whole	one sided	
4	P	purple	4 wholes	tetrahedral	109°
2	Na	grey	1 whole	one sided	
1	Ca, Mg	grey	2 wholes	angular	105°

Electron clouds

6	lone pair	light beige
6	unhybridised p-lobe	purple
6	unhybridised p-lobe	pink

Links

60	short	white
55	medium	light grey
25	long, flexibel	grey

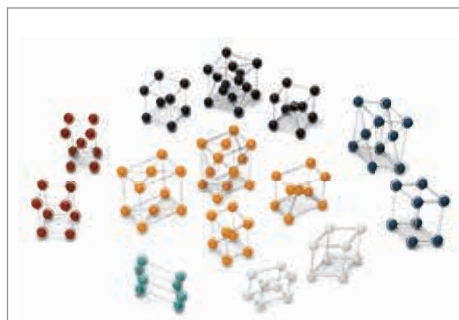

Set 14 Bravais Lattices

Set of easy to handle models of the 14 fundamental lattice types (Bravais lattices), from which Auguste Bravais postulated that practically all naturally occurring crystal lattices can be derived by shifting along the axes. Made of wooden balls in six different colours connected via metal rods. The six colours distinguish the six different systems into which the lattice types are categorised.

Diameter of balls: approx. 25 mm
Length of sides: approx. 150 mm

P-1012837

Experiment Topics:

- Energy of a photon
- Mean emission wavelength for a light emitting diode
- Characteristic of an LED
- Cut-off voltage

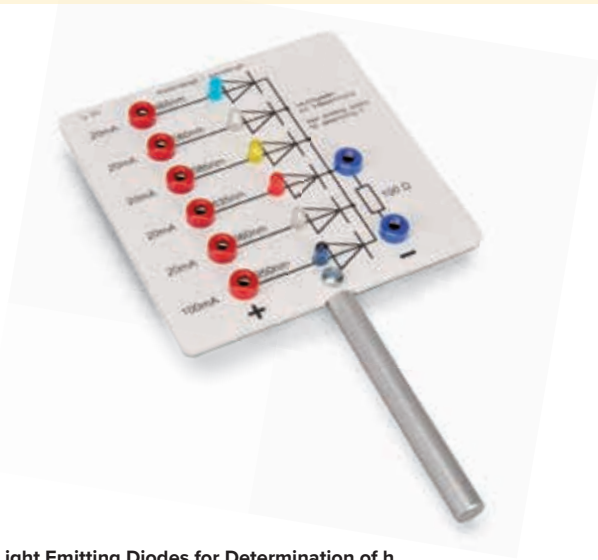

Light Emitting Diodes for Determination of h

Mounting plate with six coloured light-emitting diodes with different emission wavelengths for determining Planck's constant h by measuring the cut-off voltage as a function of the frequency of the emitted light. Light-emitting diodes with series resistors mounted on a base plate with a stem. Contact can be made from the rear via safety connector plugs..

Wavelengths: 465 nm, 560 nm, 585 nm, 635 nm, 660 nm, 950 nm
 Series resistor: 100 Ω
 Max. voltage: 6 V
 Dimensions: approx. 115x115 mm²
 Weight: approx. 120 g

P-1000917

Additionally required:

P-1003312 DC-Power Supply 0 – 20 V, 0 – 5 A (230 V, 50/60 Hz)

or

P-1003311 DC-Power Supply 0 – 20 V, 0 – 5 A (115 V, 50/60 Hz)

P-1013527 Analogue Multimeter, Escola 100

P-1001046 Stand base

Experiment leads

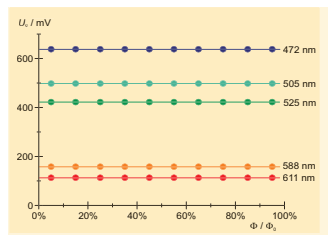

Cut-off voltage U_0 as a function of intensity (Planck's Constant Apparatus)

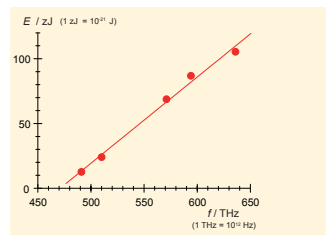

Graph of energy against frequency (Planck's Constant Apparatus)

Experiment Topics:

- Energy of a photon
- Mean emission wavelength for a light emitting diode
- Photocell
- Photo-electric effect and kinetic energy of electrons
- How electron energy depends on wavelength.
- How electron energy is independent of light intensity



Advantages:

- Simple, safe and quick-to-operate compact device
- Accuracy < 5%
- Capable of demonstrating how electron energy is independent of light intensity

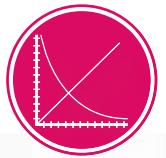

UE5010200
PDF online



Planck's Constant Apparatus

Simple, safe and quick-to-operate, compact apparatus with integrated photocell as well as a voltmeter and nano-ammeter for determining Planck's constant and the work done in emitting an electron using the stopping potential method. Five light emitting diodes (LEDs) of known mean wavelengths act as light sources of differing frequencies. The intensity of the light emitted by them can be varied from 0 to 100%.

Wavelengths: 472 nm, 505 nm, 525 nm, 588 nm, 611 nm
 Dimensions: approx. 280x150x130 mm³
 Weight: approx. 1.3 kg

Contents:

- 1 Basic apparatus with photocell, voltmeter, nano-ammeter and power supply for light sources
- 5 LEDs in casings with connector leads
- 1 Plug-in power supply 12 V AC

Planck's Constant Apparatus (230 V, 50/60 Hz)
P-1000537

Planck's Constant Apparatus (115 V, 50/60 Hz)
P-1000536



Vacuum Photocell

Evacuated photocell for demonstrating the photoelectric effect and showing that the emission of electrons increases with increasing light intensity. Mounted ready for use on a base plate with electrical wiring and clamping bar.

Cathode:	Caesium on oxidised silver
Cathode area:	2.4 cm ²
Operating voltage:	50 V, max. 200 V
Working resistance:	1 MΩ
Dark current:	<0.05 μA
Sensitivity:	20 μA/lumen
Photoelectric current density:	max. 3.0 μA/cm ²

P-1000915



Gas Filled Photocell

Gas-filled photocell for demonstrating the photoelectric effect with simple measuring instruments for use by students that also shows how the emission of electrons increases with increasing light intensity. Mounted ready for use on a base plate with electrical wiring and clamping bar.

Cathode:	Caesium on oxidised silver
Cathode area:	2.4 cm ²
Operating voltage:	50 V, max. 90 V
Working resistance:	1 MΩ
Dark current:	<0.1 μA
Sensitivity:	125 μA/Lumen
Photoelectric current density:	max. 0.7 μA/cm ²

P-1000916

External Photoelectric Effect (Hallwachs Effect)

Equipment:

- P-1000852 High-Pressure Mercury Vapour Lamp
- P-1006813 Electrometer Accessories
- P-1002835 Tripod Stand, 150 mm
- P-1002933 Stainless Steel Rod, 250 mm
- P-1002830 Universal Clamp
- P-1013526 Analogue Multimeter Escola 30

- P-1021409 Control Unit for Spectrum Lamps (230 V, 50/60 Hz)
- P-1008535 DC Power Supply 450 V (230 V, 50/60 Hz)
- P-1001025 Electrometer (230 V, 50/60 Hz)
- or
- P-1003195 Control Unit for Spectrum Lamps (115 V, 50/60 Hz)
- P-1008534 DC Power Supply 450 V (115 V, 50/60 Hz)
- P-1001024 Electrometer (115 V, 50/60 Hz)

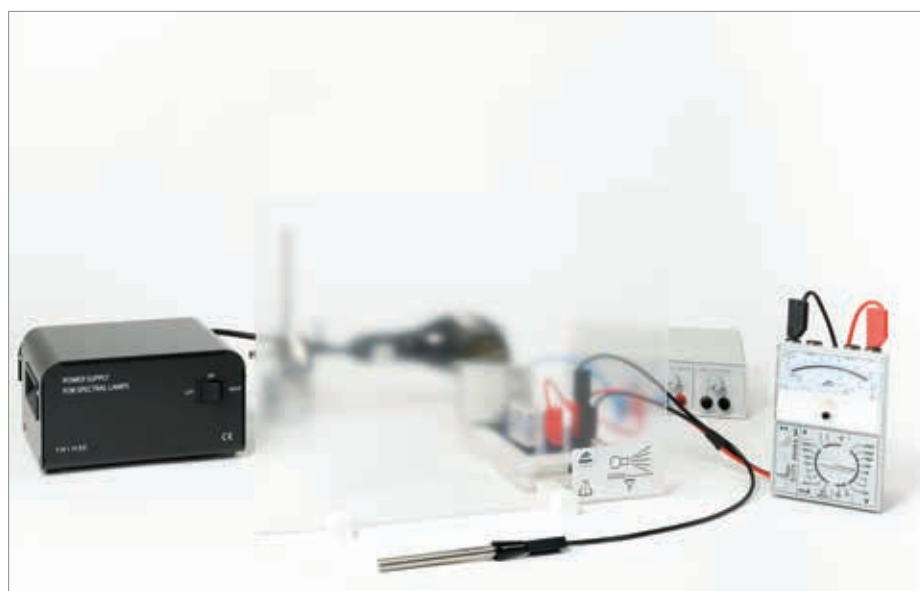

High-Pressure Mercury Vapour Lamp

High-pressure mercury vapour lamp in hardened glass bulb made of blackened borosilicate glass, with tube-shaped hole allowing emission of unfiltered ultra-violet radiation. Includes E27 lamp holder on stem and see-through screen to protect users from UV radiation.

Wavelength ranges:	UV-A, UV-B, UV-C
Power consumption:	125 W

P-1000852

External photoelectric effect with the high-pressure mercury vapour lamp

➤ Experiment set-up: Normal Zeeman effect

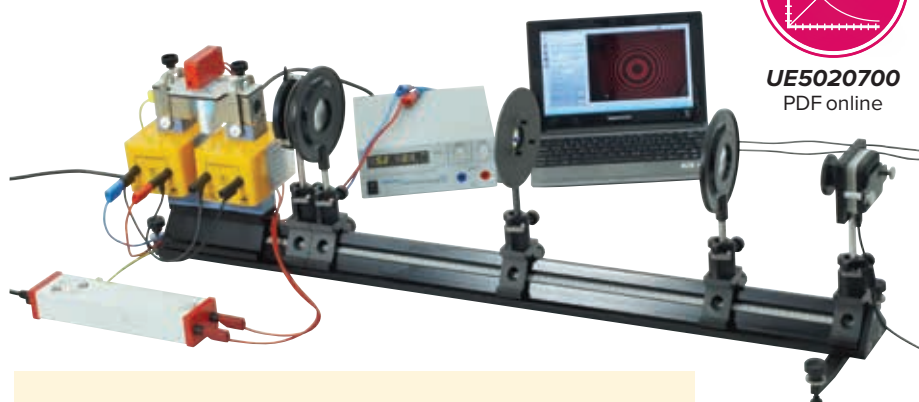

UE5020700
PDF online

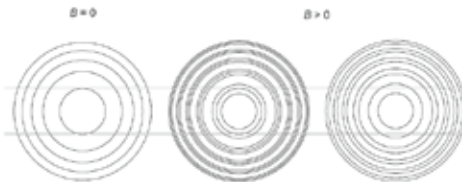

Interference pattern from etalon (left), triplet splitting with transverse Zeeman effect (centre) and doublet splitting with longitudinal Zeeman effect (right)

Experiment Topics:

- Observing splitting of red cadmium line in external magnetic field
- Transverse and longitudinal Zeeman effect
- Investigation of polarisation of doublet and triplet components
- Bohr magneton, charge per unit mass of electron

Experiment to Demonstrate Normal Zeeman Effect

This experiment involves observing the splitting of the red cadmium line perpendicular in transverse configuration or parallel in longitudinal configuration to an external magnetic field. The observation in longitudinal configuration is made possible by a stepped hole on the pole piece of the electromagnet. The light from the cadmium lamp passing through the Fabry-Pérot etalon causes interference rings to arise, which like the spectral lines themselves are split into doublets or triplets depending on the direction of the external magnetic field. The splitting of the interference rings is recorded with the help of a Moticam 1 digital camera. A red filter on the focussing lens of the Moticam selects the light of the red cadmium line, while an aperture optimises the depth of field. The accompanying software allows for qualitative observation of the live image as well as quantitative assessment with the help of photographs of the screen. The occurrence of linear or circular polarisation is analysed with the help of the polarising filter or the four-wavelength base plate with a polarising attachment. The whole experiment is set up on a stable precision optical bench system.

1 Cadmium Lamp with Accessories

1 U-Shaped Core D

2 Coils D, 900 Windings

1 Electromagnet Accessory for Zeeman Effect

1 DC Power Supply, 1 – 32 V, 0 – 20 A @230 V

In countries with 110-120 V mains voltage, a power supply unit corresponding to the power supply unit 1012857 is required.

1 Set of 15 Experiment Leads, 75 cm, 1 mm²

1 Fabry-Pérot Etalon

2 Converging Lens on Rod, f = 100 mm

1 Four Wavelength Base on Rod

1 Polarising Attachment

1 Polarisation Filter on Rod

1 Optical Bench D, 100 cm

1 Optical Base D

5 Optical Sliders D 90/36

1 Holder and Filter for Moticam

1 Moticam 1 Digital Camera

P-1021366

P-1000979

P-1012859

P-1021365

P-1012857

P-1002840

P-1020903

P-1003023

P-1021353

P-1021364

P-1008668

P-1002628

P-1009733

P-1012401

P-1021367

P-1021162



Cadmium Lamp with Accessories

For the experiment to demonstrate the normal Zeeman effect. The casing of the lamp is made of heat-resistant plastic and has both longitudinal and lateral openings, such that it is only necessary to rotate the electromagnet by 90° when swapping from transverse to longitudinal configuration. Power is supplied from the ballast unit specifically designed for the cadmium lamp, which also provides protective earthing via a connection from the ballast unit to the pole piece of the electromagnet accessory for the Zeeman effect. The cadmium lamp is positioned in the air gap of the electromagnet by securing the lamp's base plate to the pole pieces of the magnet with the help of the clamp for the Zeeman effect electromagnet (P-1021365).

Cadmium lamp:

Electrical power: max. 15 W
Operating temperature range: 5 – 40°C
Warm-up time (90% of light output): approx. 5 mins.

Lamp casing:

Dimensions: approx. 110x70x20 mm²
Weight including lamp: approx. 160 g

Ballast:

Electrical power consumption in operation with lamp: approx. 110 W
Dimensions: approx. 260x60x45 mm³
Weight: approx. 930 g

Base plate:

Dimensions: approx. 130x80x5 mm³
Weight: approx. 55 g

Protection class:

P-1021366

CAT II

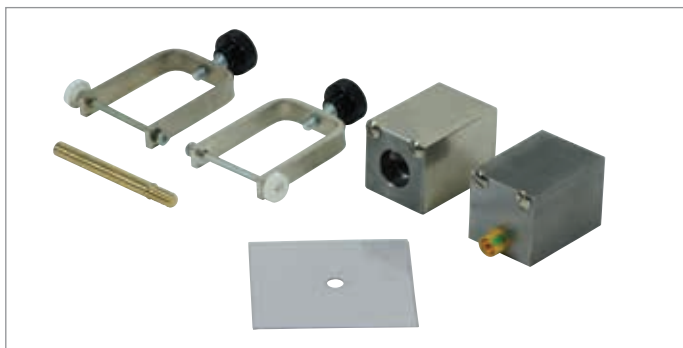

Electromagnet Accessory for Zeeman Effect

The electromagnet accessory provides a low-friction rotating bearing between the U-shaped core D (P-1000979) and the optical base D (P-1009733) and allows pole pieces and the base plate for the cadmium lamp (P-1021366) to be attached to the U-shaped core D.

Pole pieces with PE connectors:

Dimensions: 40x40x70 mm³

Pole pieces with stepped hole:

Dimensions: 40x40x70 mm³

Diameter of stepped hole: 5 – 20 mm

Clamps:

Dimensions: approx. 95x52x16 mm³

Axle pin:

Dimensions: 8x80 mm²

Thread: M8 x 14 mm

Weight: approx. 1.6 kg

P-1021365



Fabry-Pérot Etalon

For optical filtering and generation of interference rings in the experiment to demonstrate the normal Zeeman effect. The fixed etalon consists of a substrate with highly reflective, if only partially reflecting, mirror coatings on both sides. The substrate and mirrors form an optical resonator which fulfils the resonance conditions for a specific wavelength of 643.8 nm, which is that of the red cadmium line.

The inclination of the etalon to the optical axis can be adjusted by means of adjustment screws in the frame, allowing the pattern of the interference rings to be shifted both horizontally and vertically.

Wavelength: 644 nm

Substrate material: Suprasil

Refractive index: 1,4567

Coefficient of reflection: 0,85

Flatness: 32 nm ($\lambda/20$)

Aperture: 22 mm

External diameter: 130 mm

Diameter of rod: 10 mm

Height from end of rod to optical axis: 150 mm

P-1020903



Holder and Filter for Moticam

Supplement for Moticam to create an imaging system for the experiment to demonstrate the normal Zeeman effect. A red filter, which can be clipped onto the focussing lens of the Moticam camera, selects the wavelength of the red cadmium line. An aperture optimises the depth of field.

Holder:

Dimensions not including rod and threaded sleeves: approx. 80x85x10 mm³

Diameter of rod: 10 mm

Height from end of rod to optical axis: 150 mm

Red filter:

Diameter: approx. 41 mm

Thickness: 3 mm

Aperture:

Aperture: 2.2 mm

P-1021367



Polarising Attachment

For mounting on four-wavelength base (P-1021353). The combination of the two components allows for investigation of polarisation for doublet components in the case of a longitudinal Zeeman effect. An arrow marks the 0° setting for the polarisation filter.

Diameter of polarising filter: 32 mm

External diameter: 100 mm

Dimensions of attachment lugs: 20x12 mm²

Dimensions of holes: 3x5.5 mm²

Weight: approx. 62 g

P-1021364

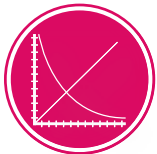

UE5020300
PDF online



Franck-Hertz experiment with neon

Franck-Hertz Experiment

The quantization of energy and the generation, recording and evaluation of spectra, along with the experimental verification thereof, is included in most of the curricula used around the world. The well known experiment first performed by James Franck and Gustav Hertz in 1913 is critically important in terms of demonstrating discrete energy states in atoms.

Power Supply Unit for Franck-Hertz Experiment

Power supply unit for operating the mercury filled Franck-Hertz tube (P-1006795 resp. P-1006794), the neon filled Franck-Hertz tube (P-1000912) or the critical potential tubes (P-1000620 and P-1000621). The equipment provides all the voltages needed to power the tubes and includes a sensitive built-in DC amplifier for measuring collector current. The voltages can simultaneously be read off a display. The accelerating voltage can be set-up manually on the apparatus or set to a saw-tooth wave form. Additional measuring inputs are also available for the anode current and accelerating voltage.

Filament voltage U_F : 4 – 12 V, continuously adjustable
 Control voltage U_G : 0 – 12 V, continuously adjustable
 Accelerating voltage U_A : 0 – 80 V
 Modes of operation: manually adjusted / saw-tooth
 Countervoltage U_E : 0 – ± 12 V, continuously adjustable, switchable polarity

Output U_E for collector current I_E : $I_E = U_A \cdot 38 \text{ nA/V}$ (0 – 12 V)
 Output U_Y for accelerating voltage U_A : $U_X = U_A / 10$
 Outputs: 4 mm safety sockets
 Input: BNC socket
 Dimensions: approx. 160x132x210 mm³
 Weight: approx. 3.4 kg

Power Supply Unit for Franck-Hertz Experiment (230 V, 50/60 Hz) P-1012819

Power Supply Unit for Franck-Hertz Experiment (115 V, 50/60 Hz) P-1012818

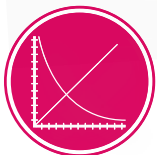

UE5020400
PDF online



Franck-Hertz experiment with mercury



Franck-Hertz Tube with Neon Filling on Base

Highly evacuated electron tube containing neon, mounted on a base with socket connection for demonstrating that free electrons colliding with neon atoms emit energy in quantized packets and for determining the excitation energy of the 3P_0 or 3S_1 states at about 19 eV. When excited, these states emit visible light due to the energy drop from intermediate levels to a ground state at an excitation energy of about 16.7 eV. The light so emitted is in the red-yellow region of the spectrum. Parallel bands of light are formed between the control grid and the accelerator grid and can be observed through a window. The Franck-Hertz neon tube can be operated at room temperature. Tetrode with indirectly heated cathode, mesh control grid, mesh accelerating grid and collector (counter) electrode. Mounted on a base with colour coded connection sockets.

Filament voltage:	4 – 12 V
Control voltage:	9 V
Accelerating voltage:	max. 80 V
Counter voltage:	1.2 – 10 V
Tube:	approx. 130 mm x 26 mm diam.
Base with connector sockets:	approx. 190x115x115 mm ³
Weight:	approx. 450 g

P-1000912

Additionally required:

P-1012819 Power Supply Unit for Franck-Hertz Experiment (230 V, 50/60 Hz)

or

P-1012818 Power Supply Unit for Franck-Hertz Experiment (115 V, 50/60 Hz)

P-1020910 Digital Oscilloscope 2x30 MHz

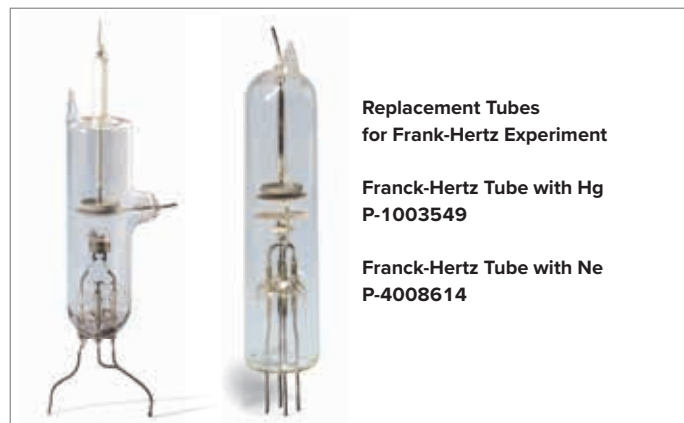

Replacement Tubes for Franck-Hertz Experiment

Franck-Hertz Tube with Hg
P-1003549

Franck-Hertz Tube with Ne
P-4008614



Franck-Hertz Tube with Mercury Filling and Heating Chamber

Highly evacuated electron tube containing mercury in a heating chamber for demonstrating the discrete nature (quantization) of the energy released by free electrons in collisions with mercury atoms, and for determining the excitation energy of the mercury resonance line ($6^1S_0 - 6^3P_1$), which is 4.9 eV. The electron tube must be heated in the chamber to generate the necessary mercury vapour pressure to achieve a sufficiently high probability of collisions between electrons and mercury atoms. Electron tube with a plane parallel electrode system consisting of an indirectly heated oxide cathode with aperture, a grid and a collecting electrode. Front plate with printed tube symbol visible from a distance. Electric heating chamber with continuous temperature control and digital temperature display showing actual and set-point temperatures. In lacquered metal housing with two observation windows, opening with spring clip for thermometer, and thermally insulated carrying handle. Temperature measurement and control is handled by an integrated microcontroller and a Pt100 thermocouple.

Heater voltage:	4 – 12 V
Grid voltage:	0 – 70 V
Suppressor voltage:	approx. 1.5 V
Tube dimensions:	approx. 130 mm x 26 mm diam.
Heater output:	400 W
Temperature range:	160° C – 240° C
Temperature constancy:	approx. $\pm 1^\circ$ C
Overall dimensions:	approx. 335x180x165 mm ³
Weight:	approx. 5.6 kg

Franck-Hertz Tube with Mercury Filling and Heating Chamber (230 V, 50/60 Hz)
P-1006795

Franck-Hertz Tube with Mercury Filling and Heating Chamber (115 V, 50/60 Hz)
P-1006794

Additionally required:

P-1012819 Power Supply Unit for Franck-Hertz Experiment (230 V, 50/60 Hz)

or

P-1012818 Power Supply Unit for Franck-Hertz Experiment (115 V, 50/60 Hz)

P-1020910 Digital Oscilloscope 2x30 MHz

Gustav Hertz Experiment:

Gustav Hertz' experiment is a development of the Franck-Hertz experiment. Atoms are excited or even ionised by means of inelastic collisions with electrons inside an evacuated tube. If the kinetic energy of the electrons exactly matches a critical potential or ionisation level, the electrons transfer all their energy to the atoms and can then be drawn away to the collector ring in the tube with the help of a small voltage. At this point, the collector voltage reaches a maximum.



Control Unit for Critical Potentials Tubes

Control unit for operating the critical potentials tubes. Equipped with an output for sawtooth acceleration voltages; adjustable upper and lower limits of the acceleration voltage. Integrated pico-ammeter amplifier for anode current measurement. Allows recording of the acceleration voltage as a function of the anode current. A slow sawtooth voltage (approx. 6 seconds per cycle) is available with an interface or XY-recorder; a sawtooth voltage with a repetition rate of 20 Hz is available for oscilloscopic observations. Includes plug-in power supply.

- Input: Anode current measurement via a BNC jack
- Outputs:

 - Tube: Sawtooth acceleration voltage of 0 – 60 V, 20 Hz
 - Fast: Voltage signal of 0 – 1 V, proportional to the acceleration voltage, for oscilloscopic observations
 - Slow: Voltage signal of 0 – 1 V proportional to the acceleration voltage, for recording data with an XY-recorder or interface
 - Anode current: Voltage signal of 0 – 1 V proportional to the anode current (1 V/nA)
 - Supply voltage: 12 V AC
 - Dimensions: approx. 170x105x45 mm³

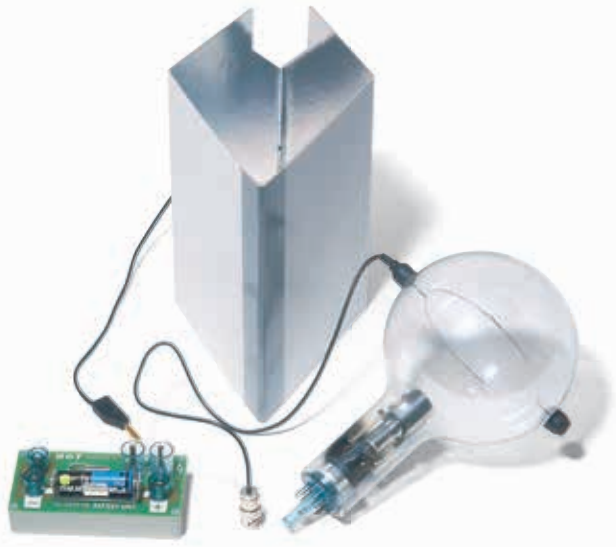

Critical Potentials Tube S

Hertz electron tube for quantitative investigations of inelastic collisions of electrons with inert gas atoms, determination of ionization energy of helium resp. neon, as well as resolution of the energy states of various primary and orbital angular-momentum quantum numbers. Includes shielding and battery unit for the collector voltage (battery not included).

- Cathode filament voltage: $U_F \leq 7 \text{ V}$
- Anode voltage: $U_A \leq 60 \text{ V}$
- Anode current: $I_A \leq 10 \text{ mA}$
- Collector voltage: $U_C = 1.5 \text{ V}$
- Collector current: $I_C \leq 200 \text{ pA}$

Critical Potentials Tube S with He Filling

Critical potentials of helium:

- 2³S: 19,8 eV
- 2¹S: 20,6 eV
- 2³P: 21,0 eV
- 2¹P: 21,2 eV
- 3³S: 22,7 eV
- 3¹S: 22,9 eV
- 3³P: 23,0 eV
- 3¹P: 23,1 eV
- 4³S: 23,6 eV
- 4¹S: 23,7 eV
- Ionisation: 24,6 eV

P-1000620

Critical Potentials Tube S with Ne Filling

Critical potentials of neon:

- 2p5³s¹: 16,6 eV
- 2p5³p¹: 18,4 eV
- 2p5⁴s¹: 19,7 eV
- 2p5⁴p¹: 20,3 eV
- 2p5⁴d¹: 20,6 eV
- Ionisation: 21,6 eV

P-1000621

Control Unit for Critical Potentials Tubes (230 V, 50/60 Hz) P-1008506

Control Unit for Critical Potentials Tubes (115 V, 50/60 Hz) P-1000633

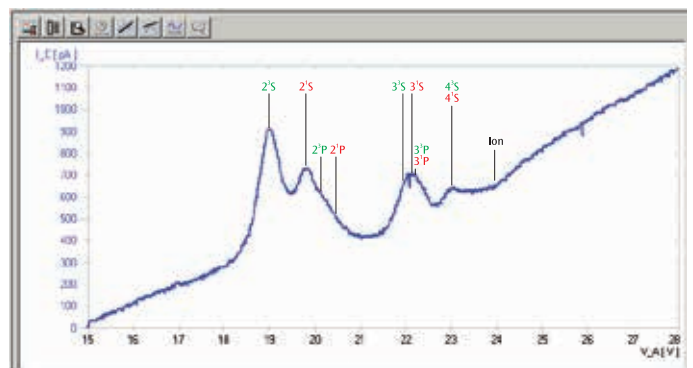

Collector current I_R as a function of accelerating voltage U_A . Gas filling: He.



UE5020500
PDF online

➤ Experiment set-up with the control unit for critical potentials tubes

Additionally required:

- P-1014525 Tube Holder S
 - P-1008506 Control Unit for Critical Potentials Tubes (230 V, 50/60 Hz)
 - P-1003312 DC-Power Supply 0 – 20 V, 0 – 5 A (230 V, 50/60 Hz)
- or
- P-1000633 Control Unit for Critical Potentials Tubes (115 V, 50/60 Hz)
 - P-1003311 DC-Power Supply 0 – 20 V, 0 – 5 A (115 V, 50/60 Hz)

Additionally recommended:

- P-1002785 Digital-Multimeter P3340
- P-1020857 PC Oscilloscope, 2x25 MHz
- P-1002748 HF Patch Cord, BNC/4 mm Plug (2x)
- P-1002843 Set of 15 Safety Experiment Leads 75 cm

➤ Experiment set-up with the control unit for the Franck-Hertz experiment

Additionally required:

- P-1014525 Tube Holder S
 - P-1012819 Control Unit for the Franck-Hertz Experiment (230 V, 50/60 Hz)
- or
- P-1012818 Control Unit for the Franck-Hertz Experiment (115 V, 50/60 Hz)

Additionally recommended:

- P-1020857 PC Oscilloscope, 2x25 MHz
- P-1002748 HF Patch Cord, BNC/4 mm Plug (2x)
- P-1002843 Set of 15 Safety Experiment Leads 75 cm





Experiment set-up for transmissive illumination of sodium fluorescence tube with a beam of white light

Experiment Topics:

- Sodium resonance fluorescence
- Absorption of Na spectral lines in a sodium mist



Absorption of white light (left) and yellow sodium light (right) in a glass tube containing sodium vapour. In each case, the light is dispersed far enough for it to pass unobstructed to the left and right of the tube.

Sodium Fluorescence Tube on Furnace Wall

Highly evacuated glass tube containing multiply distilled sodium for demonstrating the resonance fluorescence of sodium vapour. Filled with argon. The tube is heated in the furnace up to temperatures of between 180°C and 200°C in order to achieve sufficient pressure of sodium vapour. The entire tube emits yellow light at the wavelength of the sodium D line when it is brought to the heated state and illuminated with sodium spectral light. The sharply defined sodium D line appears in the spectrum. If it is instead illuminated with white incandescent filament light, the transmitted light exhibits a dark absorption line at the position of the sodium D line. Absorption can be demonstrated even without the use of a spectrometer due the clear shadow formed when yellow sodium light passes through the tube.

Dimensions of tube: 170 mm x 42 mm diam.

Dimensions of hotplate: approx. 230x160 mm²

Weight: approx. 550 g

P-1000913

Additionally required:

P-1012820 Heating Chamber (230 V, 50/60 Hz)

or

P-1006796 Heating Chamber (115 V, 50/60 Hz)

Additionally recommended:

P-1003541 Sodium Vapour Spectrum Lamp

P-1021409 Choke for Spectrum Lamps (230 V, 50/60 Hz)

or

P-1003195 Choke for Spectrum Lamps (115 V, 50/60 Hz)

P-1020630 Optical LED Lamp

P-1002835 Tripod Stand, 150 mm

P-1003022 Convex lens on stem, 50 mm

P-1001045 Barrel Foot, 0.9 kg

P-1001045 Hand Held Spectroscope with Amici Prism



Observation of sodium vapour in yellow sodium light



Heating Chamber

Electric heating chamber with continuous temperature control and digital temperature display showing actual and set-point temperatures. In lacquered metal housing with two viewing windows, opening with spring-clip for thermometer and thermally insulated carrying handle. Temperature measurement and control is handled by an integrated microcontroller and a Pt100 thermocouple.

Dimensions of front opening: approx. 230x160 mm²
Heating power: 400 W

Maximum temperature: 300°C (230 V, 50/60 Hz)
250°C (115 V, 50/60 Hz)

Temperature constancy: approx. ±1°C

Dimensions: approx. 335x180x165 mm³
Weight: approx. 5.6 kg

Heating chamber (230 V, 50/60 Hz)
P-1012820

Heating chamber (115 V, 50/60 Hz)
P-1006796



X-Ray Apparatus

The experiment chamber is contained in a closed, radiation-proof housing with a transparent synthetic-glass shield. If the synthetic-glass shield is opened, the high-voltage source for the X-ray tube is deactivated automatically. The high-vacuum X-ray tube with a directly heated tungsten cathode and copper anode is positioned in a borosilicate glass chamber with a thin-walled, concave ray emission window. A lead-glass hood with a collimator causes X-rays to emerge in parallel with the experiment plane and provides a shield against scattered radiation. The horizontal counter-tube goniometer consists of a central sample holder and a swiveling arm. In the form of a slide tray, this arm serves as a mount for the Geiger-Müller tube (P-1000661), Ionisation chamber (P-1000668) as well as experimental devices in slide format or on a 5x5 cm base plate (for example, from P-1000665, P-1000666, P-1000667). The swiveling arm can be rotated manually independently of the sample holder, or at a fixed mutual angle with a ratio of 2:1, for instance, for experiments involving Bragg's reflection. The device is equipped with angle and millimeter scales, position markings for experimental devices, as well as radiation-proof bushings for cables and hoses. Including one cable to measure the tube current.

Anode voltage:	20/30 kV, switchable and electronically stabilised
Emission current:	0 to 80 μ A, continuously adjustable and electronically stabilised
Cathode heating:	4 V, 1 A
Focal spot:	5x1 mm ²
Anode material:	Cu
Lead-glass collimator:	radiation emission aperture with 5 mm diam.
Ray divergence:	better than 10°
Characteristic radiation wavelength:	Cu-K _{α} : 154 pm, Cu-K _{β} : 138 pm
Cable to measure tube current:	approx. 50 cm, 2.5 mm jack / 4 mm plugs (red / black)

Counter-tube goniometer:

Swiveling ranges:	0°, +10° to +130° and -10° to +130° relative to the ray axis
Angular coupling:	independent of the sample holder or with a ratio of 2:1
Measurement accuracy of Bragg's angle:	5 arc minutes
Timer:	0 to 55 minutes, continuously adjustable
Power consumption:	100 VA

Dimensions:

X-ray apparatus:	approx. 250 mm x 370 mm diam.
X-ray tube:	approx. 100 mm x 32 mm diam.
Weight:	approx. 9 kg

X-Ray Apparatus (230 V, 50/60 Hz) P-1000657

X-Ray Apparatus (115 V, 50/60 Hz) P-1000660

Spare Tube for X-Ray Apparatus (not shown)

Spare tube with Cu anode for X-ray apparatus (P-1000657) and X-ray apparatus (P-1000660).
P-1000664

Experiment Topics:

- Properties of X-rays:
 - Transmission
 - Linear propagation
 - Ionisation
 - X-ray photography
- Fluorescent radiation
- Shielding of X-rays
- Absorption experiments
- Distance law
- Dosimetry and radiation protection
- Diffraction of X-rays:
 - Laue's recordings
 - Debye-Scherrer's recordings
 - Bragg's reflection
 - Duane-Hunt's displacement law (h-determination)
- Moseley's law

Motor Drive Debye-Scherrer (230 V, 50/60 Hz)

For structural investigations using the rotating-crystal method, suitable for the Debye-Scherrer camera (contained in P-1000665). Power transmission via bevel gears.

Power consumption: 3 VA

P-1019216

Recommended for operation at a mains supply voltage of 100 – 120 V:

Voltage Transformer 120 V / 230 V (not shown)

P-1003649



Crystallography Accessories

These accessories for the basic equipment set (P-1000665) are intended for additional crystallographic experiments as well as treatments of Moseley's law, the Debye-Scherrer method, Bragg's reflection and material tests.

Contents:

4 foils, Fe, V, Mn, Cr

2 single crystals, KCl, RbCl

5 powder samples, NaF, SiC, NH₄Cl, MgO, Al

2 wire samples, Al, Nb (3x each) for Debye-Scherrer experiments

10 polyethylene threads

1 disc for calculating Bragg's angle

P-1000666



Radiography Accessories

These accessories for the basic equipment set (P-1000665) are intended for investigating the following topics: scattering, absorption; dependence on acceleration voltage, emission current and penetration power, resolving power; shielding, half width; exposure time, non destructive materials testing.

Contents:

1 Maltese cross

1 phantom

1 pin diaphragm

1 aluminium layer, stepped

5 aluminium absorbers, 0.1/0.25/0.5/1.0/2.0 mm

1 lead absorber, 0.5 mm

1 plastic absorber

2 magnets

4 materials testing models (porosity, fissures, welding seam, painting)

P-1000667





Geiger-Müller Tube T

Self-extinguishing halogen-trigger counter tube for registering alpha, beta, gamma and X-radiation. Enclosed in a plastic housing with a holder for mounting on the swiveling arm of the X-ray apparatus (P-1000657 or P-1000660); equipped with a firmly installed BNC patch cord. Includes a retention clip for other types of mounting.

Dose-rate range: $10^{-3} - 10^2 \text{ mGy/h}$
 Mass of the active surface: Mica: $2.0 - 3.0 \text{ mg/cm}^2$
 Operating voltage: 500 V
 Dimensions: approx. $50 \times 50 \text{ mm}^2 \times 22 \text{ mm}$ diam.
 Cable length: approx. 1 m

P-1000661



Basic Set Bragg

Basic equipment set for Bragg's reflection experiment with a LiF and a NaCl crystal.

Contents:

- 1 slit diaphragm collimator, 1 mm
- 2 slit diaphragms, 1 mm/3 mm
- 2 single crystals, LiF, NaCl
- 1 Geiger Müller tube (P-1000661)

P-1008508



Basic Equipment Set

Equipment set for qualitative and quantitative experiments involving, for instance, linear propagation, ionisation, penetration capacity of X-radiation and X-ray photography; also for demonstrating the wave nature of X-radiation, investigating fluorescent X-radiation and determining mass-absorption coefficients. In a specially moulded storage box.

P-1000665

Contents:

- 1 fluorescent screen
- 1 Debye-Scherrer camera
- 2 film cassettes
- 1 lead mask
- 2 plate electrodes on a 4 mm contact pin
- 1 slit diaphragm collimator, 1 mm
- 1 pin diaphragm collimator, 1 mm diam.
- 1 ancillary magazine with a circular aperture
- 2 slit diaphragms, 1 mm/3 mm
- 1 pin diaphragm, 9.5 mm diam.
- 2 single crystals, LiF, NaCl
- 2 mini crystals, LiF
- 1 powder sample, LiF
- 10 copper wires
- 4 absorption foils, Ni, Cu, Co, Zn
- 1 scattering-foil revolver, coated with V, Cr, Mn, Fe, Co, Ni, Cu, Zn
- 1 set of assembly aids (acetate adhesive, clips)
- 1 storage box, specially moulded

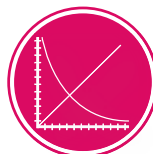

UE7010100
PDF online

Bragg Driver

The Bragg driver is a combination of hardware and software which allows the user to collect X-ray diffraction data in combination with the X-ray apparatus (P-1000657 or P-1000660). It provides the high voltage and counting circuitry for the Geiger Müller tube (P-1000661) and includes a software program that allows the user to control the driver and collect data. It includes the USB powered drive, a drive gear, an USB cable and a powder compressor. Scans can be obtained for all crystals available in the basic equipment set (P-1000665) and the crystallography accessories (P-1000666). An additional feature includes the ability to scan powders and foils. The software allows selection of scan angles, resolution, and time per step. Once the experiment is completed the software permits zoom-in on the data and the facility to add comments to the file. Data can be exported to a spreadsheet for further analysis.

Time interval for automatic data saving:	30 s
Angular range:	12° – 120°
Time per step:	≥ 0.1 s
Angular step:	≥ 0.05°
GM tube voltage:	0 – 1000 V

P-1012871

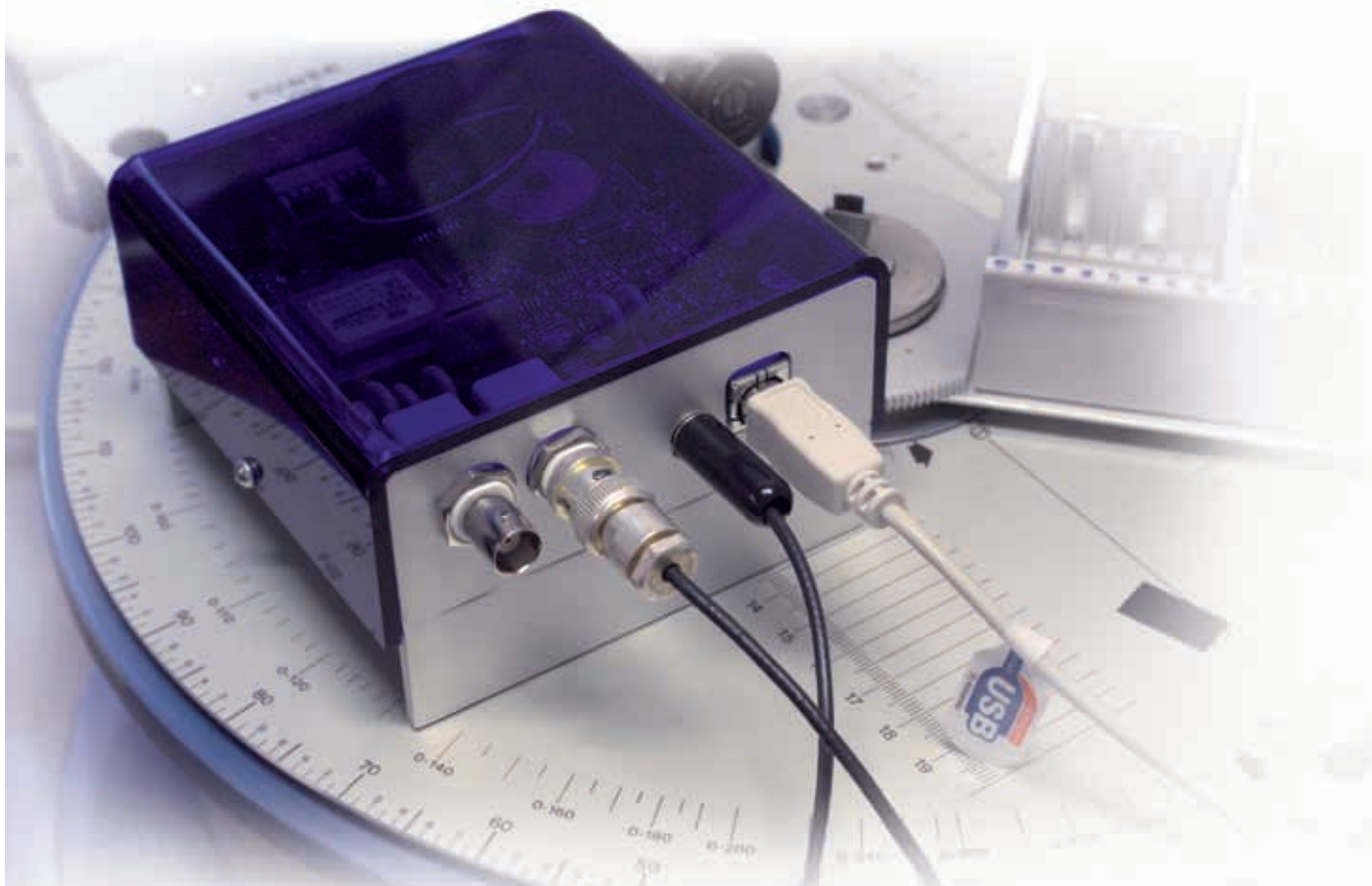

Recommended equipment:

Art. No.		Basic	Intermediate	Advanced
P-1000657 or P-1000660	X-ray Apparatus	yes	yes	yes
P-1000661	Geiger Müller Tube T	yes	yes	yes
P-1012871	Bragg Driver	yes	yes	yes
P-1000665	Basic Equipment Set	yes	yes	yes
P-1000666	Crystallography Accessories		yes	yes
P-1000667	Radiography Accessories			yes
P-1019216	Motor Drive		yes	yes
P-1000669	Filmpack 2	yes	yes	yes
P-1000670	Filmpack 4	yes	yes	yes

Basic:

Basic experiments using photographic techniques and Geiger Müller tube like Laue experiments, Bragg diffraction experiments, experiments on inverse square law, emission, rectilinear propagation, penetration and absorption of X-rays.

Intermediate:

Basic experiments and experiments on Moseley, Debye-Scherrer diffraction, size of the unit cell in salt crystals in addition.

Advanced:

Intermediate experiments and experimental investigations into radiography, film and the properties of x-rays in addition.

Bragg curve for LiF

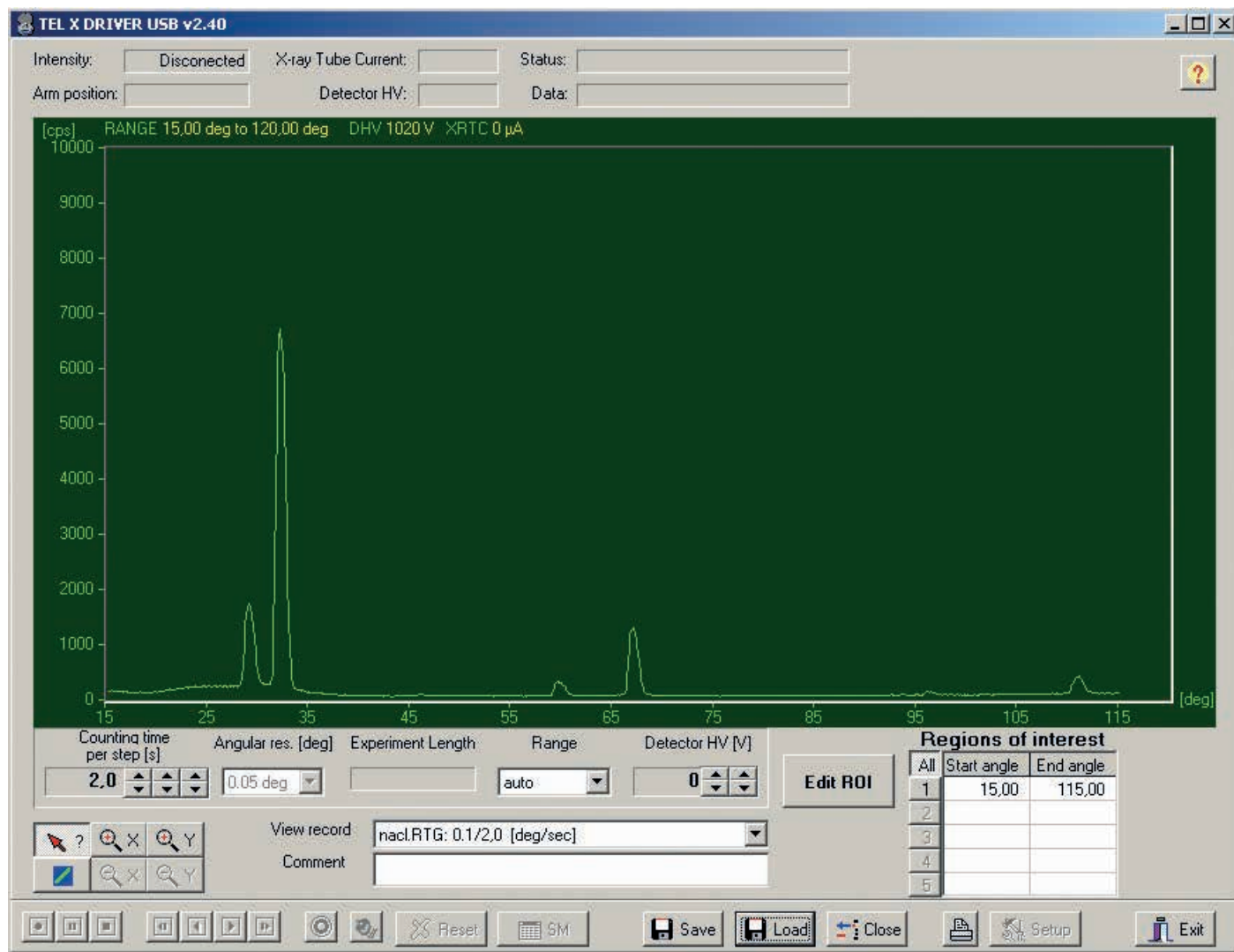

X-ray Energy Detector

X-ray detector for recording energy spectra of X-rays or γ radiation in the energy range of approx. 2 keV to 60 keV. It mainly consists of a Si-PIN photodiode which is integrated in a metal housing together with a charge sensitive preamplifier, a main amplifier with pulse shaping and a digital signal processing circuit. The detector holder is particularly designed for installation on the swiveling arm of the X-ray apparatus (P-1000657 or P-1000660). The power supply is ensured via the USB port of a PC. Including CD with measuring and evaluation software for PC.

Energy range:	approx. 2 keV up to 60 keV
Energy resolution (FWHM):	0.55 keV at $E_{\text{FeK}\alpha} = 6.40 \text{ keV}$
Entrance window:	Plastics (absorption equivalent to Graphite with $d = 40 \mu\text{m}$)
Detector:	Si-PIN photo diode
Active Area:	0.8 mm diam.
Thickness:	approx. 200 μm
Dead time per pulse:	approx. 200 μs
Connection:	USB
Cable length:	1.75 m
Dimensions:	approx. 80 mm x 22 mm diam.
Mass:	approx. 150 g

P-1008629

Additionally required:

P-1000657 X-Ray Apparatus (230 V, 50/60 Hz)

or

P-1000660 X-Ray Apparatus (115 V, 50/60 Hz)

Additionally recommended:

P-1012868 Set of Fluorescence Samples

Experiment Topics:

- X-ray energy spectroscopy
- Compton effect
- X-ray fluorescence spectroscopy
- Absorption experiments
- Bragg's reflection
- Duane-Hunt's displacement law
- Moseley's law



UE7020100
PDF online

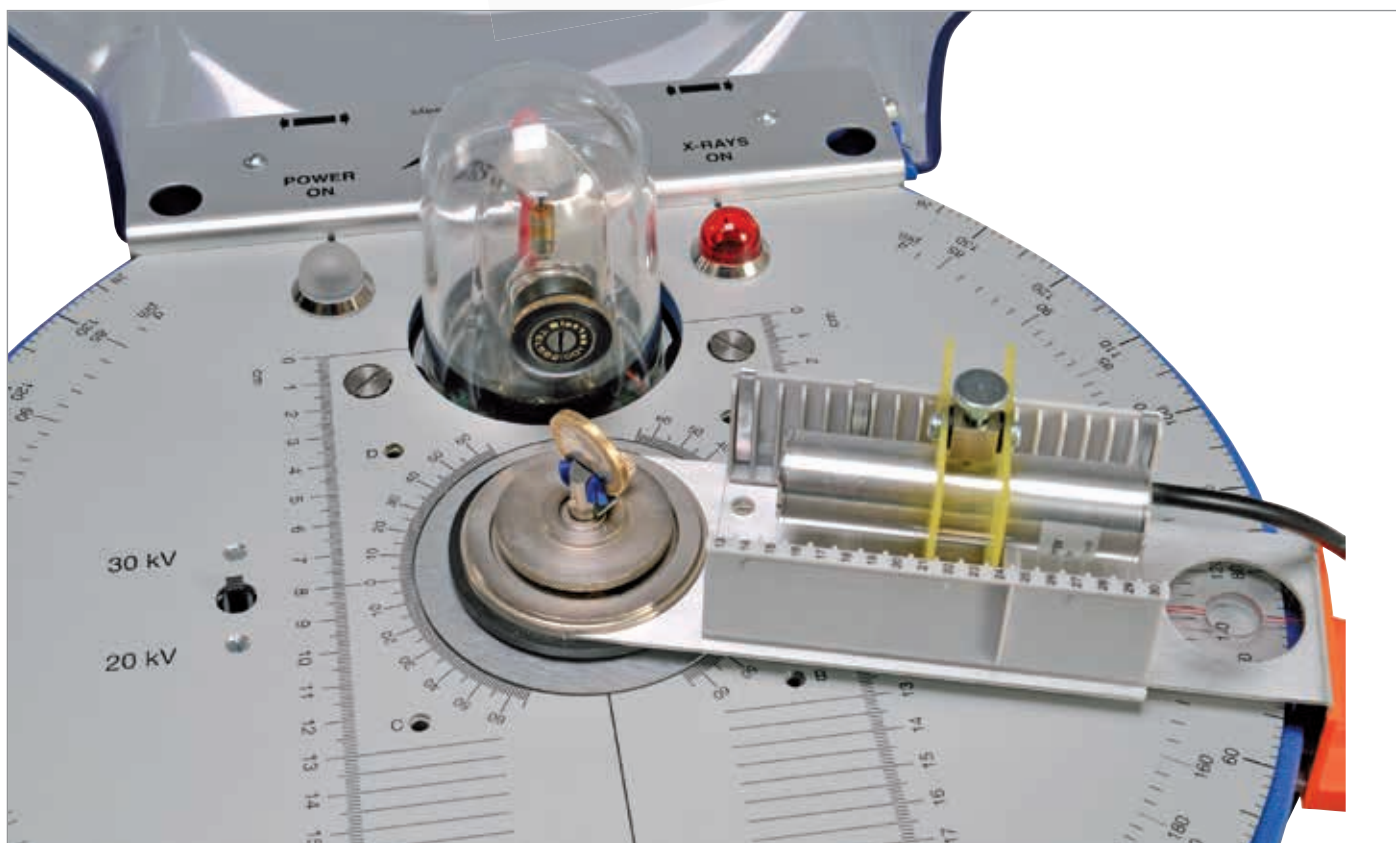

Simplified energy band diagram for an atom with characteristic X-ray lines

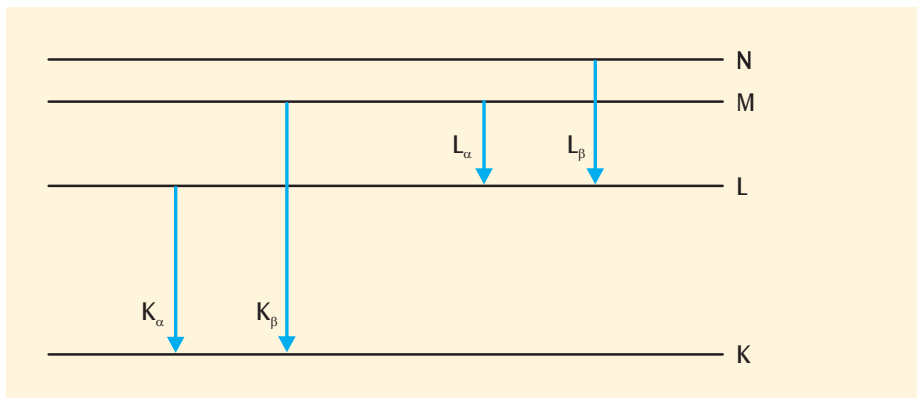

X-ray fluorescence spectrum for a one euro coin

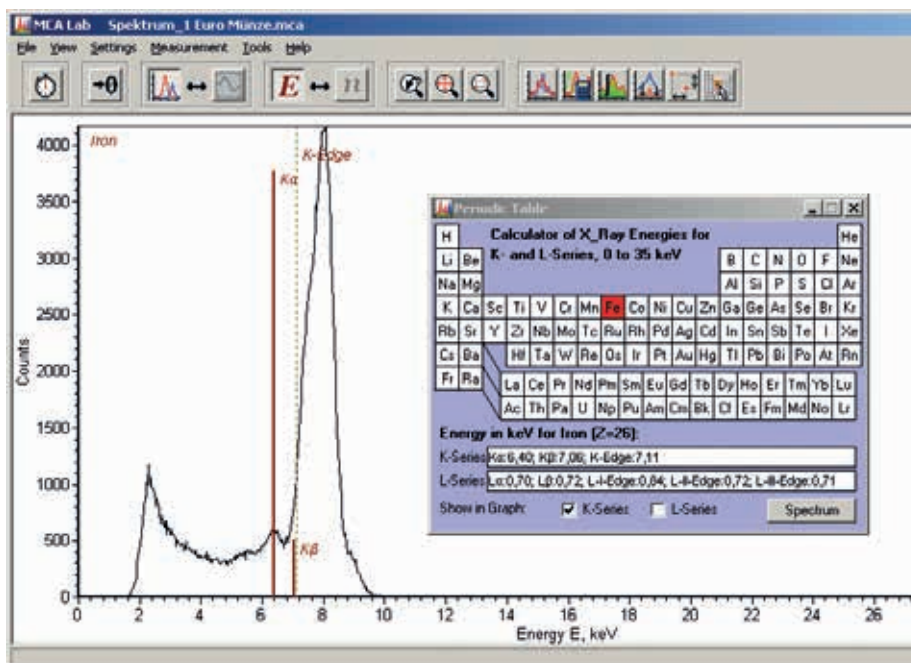

X-ray fluorescence spectra for wrought iron (red) and stainless steel (black)

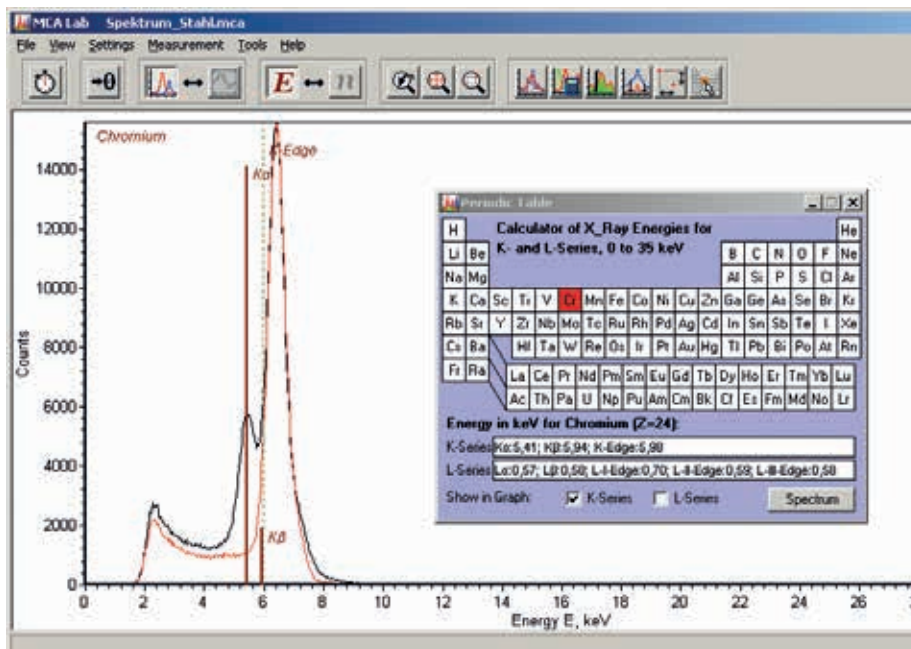



Set of Fluorescence Samples

Set of 7 samples for material analysis with the X-ray energy detector (P-1008629). The material composition can be determined from the energies of the appropriate X-ray fluorescence lines. Thus, for example the difference between stainless and low carbon steel, or between copper, brass and bronze can be seen clearly.

Materials:

Stainless Steel S321, Low Carbon Steel, Copper C101, Brass C260, Bronze C220, Zinc and Lead.

P-1012868



Ionisation Chamber

Intended for investigating the ionisation of air and other gases brought about by X-radiation at different pressures (saturation characteristics, model of a Geiger-Müller tube, dosimetry). Possesses a cylinder-shaped cathode, rod-anode and hose shaft for evacuating and introducing gases.

Operating voltage: max. 2 kV
 Ionisation current: $10^{-11} - 10^{-10}$ A
 Rod-electrode: approx. 75 mm long
 Chamber: approx. 85 mm x 25 mm diam.
 Hose shaft: approx. 5 mm diam.

P-1000668

Additionally required:

P-1003310 High Voltage Power Supply 5 kV (230 V, 50/60 Hz)

and

P-1001025 Electrometer (230 V, 50/60 Hz)

or

P-1003309 High Voltage Power Supply 5 kV (115 V, 50/60 Hz)

and

P-1001024 Electrometer (115 V, 50/60 Hz)

P-1006813 Electrometer Accessories

P-1013527 Analogue Multimeter Escola 100

P-1002751 Adaptor BNC/Jack 4-mm-Plugs

P-1002849 Pair Safety Experiment Leads, 75 mm

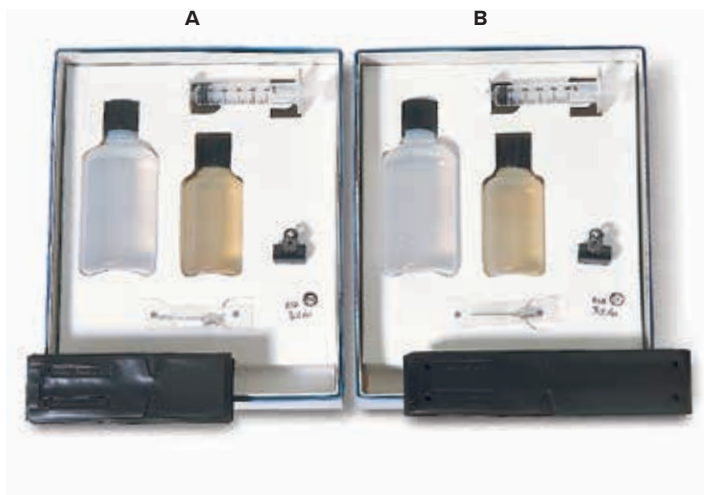

A. Filmpack 2

Highly sensitive film (38x35 mm²) for α -, β - and X-radiation. Single packaging in opaque plastic cases allows development and fixing in daylight (duration: approx. 6 minutes).

Contents:

20 film sheets (38x35 mm²) in light-tight plastic cases

1 bottle of X-ray developer

1 bottle of X-ray fixer

1 syringe with a cannula for introducing chemicals into the film cases

1 metal clip

P-1000669

B. Filmpack 4

Like P-1000669, but consisting of 12 film sheets, 150x12 mm², in light-tight plastic cases for a Debye-Scherrer camera.

P-1000670

A. Geiger-Müller Counter Tube

Self-quenching halogen pulse ionisation chamber for detecting alpha, beta, gamma and x-ray radiation. In metal housing with mica window, removable mounting clamp with shaft. Long plateau length.

Filling:	Neon/argon mixture, halogen as quenching agent
Cathode dimensions:	approx. 39x14 mm ²
Window:	mica, 9 mm diam.
Mass per unit area:	1.5 – 2.0 mg/cm ²
Plateau length:	400 V – 600 V
Operating voltage:	400 – 600 V (recommended: 500 V)
Relative plateau slope:	0.04 %/V
Dead time:	90 µs
Limiting resistor:	10 MΩ, integrated in holder
Shaft:	approx. 100 mm x 10 mm diam.
Dimensions counter tube:	approx. 85 mm x 25 mm diam.
Weight:	approx. 160 g

P-1001035

Additionally required:

P-1002746 HF Patch Cord, 1 m

P-1001033 Digital Counter (230 V, 50/60 Hz)

or

P-1001032 Digital Counter (115 V, 50/60 Hz)

B. Digital Counter

Digital counter/timer for measuring duration of motion, transition times, periods, pendulum periods and frequencies, as well as for counting events or Geiger tube pulses. Includes a speaker that can be turned on and off, power supplies for direct connection to light barriers (P-1000563) or for powering a Geiger-Müller counter (P-1001035). For event counting, a fixed counting period can be programmed in a range from 1 s to 99999 s. Counter events (start, stop) can either be triggered by a signal to the input sockets or manually via switches. Includes plug-in power supply.

Time measurement:	0.1 ms – 99999 s
Resolution:	0.1 ms / 1 ms / 0.1 s
Frequency measurement:	1 – 100 kHz, where voltage > 1.5 V _{pp}
Resolution:	1 mHz (1 – 100 Hz), 1 Hz (1 – 100 kHz)
Counting periods:	1/10/60/100 s or manually triggered
Input A:	miniDIN 8 socket, 4 mm safety sockets
Input B:	miniDIN 8 socket, 4 mm safety sockets
Input voltage A:	0.5 V – 15 V AC
Input voltage B:	1 V – 15 V AC
Active edge	Rising/falling
Counter tube input:	BNC socket
Power supply:	550 V / 1 MΩ
Display:	5-digit LED display
Operating voltage:	9 – 12 V DC via plug-in power supply
Dimensions:	approx. 250x100x160 mm ³
Weight:	approx. 0.8 kg

Digital Counter (230 V, 50/60 MHz)

P-1001033

Digital Counter (115 V, 50/60 MHz)

P-1001032



C. Geiger Counter

Versatile, easy to use and compact precision instrument for measuring α-, β- and γ-radiation. With filter selection switch at the front of the Geiger-Müller counter tube for filtering out types of radiation (γ/β, γ/α/β or γ only), large display and integrated USB interface. Including USB cable, Windows software, and operating instructions. The following functions and operating modes are available for measurement:

- Standard mode for displaying the current radiation level. Display of the equivalent dose as a numerical value and as bar chart and display of the time until a selected cumulative dose limit is reached (default 5 µSv/h). Also equipped with variable acoustic and optical warning threshold signal and display of average radiation from previous day.
- Pulse counting either permanent or with variable gate time. Gate time adjustable in seconds, minute or hours. Additional optional acoustic count indication.
- Count rate measurement. The pulses registered are measured successively and converted into a count rate (number of pulses per second).
- Integrated display of date and time for correct recording of measured radiation.
- The number of pulses registered is stored in the internal memory. This facilitates recording e.g. of weekly values for up to 10 years.
- Computer docking station. The software enables the measured data to be evaluated and processed on an MS-Windows PC.

Radiation types:	α from 4 MeV, β from 0.2 MeV, γ from 0.02 MeV
Measured variables:	equivalent dose in Sv/h, mSv/h, µSv/h pulses/s, pulses/variable time interval
Display:	LCD, 4 digit, numerical with display of measured variable, quasi analogue bar chart, operating mode indicators
Radiation detector:	End window Geiger-Müller counter tube, stainless steel housing with neon-halogen filling
Measuring length:	38.1 mm
Measuring diameter:	9.1 mm
Mica window:	1.5 – 2 mg/cm ²
Gamma sensitivity:	114 pulses/min for ⁶⁰ Co radiation = 1 µSv/h in background radiation energy band
Background rate:	approx. 10 pulses per minute
Internal memory:	2 kilobytes
Battery life:	approx. 3 years
Dimensions:	approx. 163x72x30 mm ³
Weight:	approx. 155 g

P-1002722



A

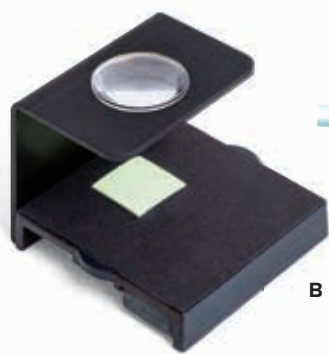

B

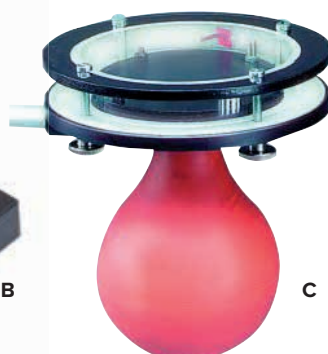

C

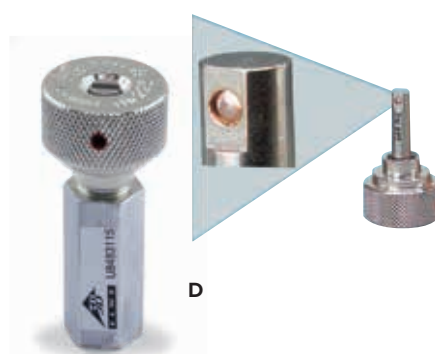

D

Important note:

In accordance with radiation protection regulations, anyone who works with radioactive materials or ionising radiation or plans to do so has the following obligations:

- Avoid unnecessary exposure to radiation or contamination of persons or of the environment.
- Ensure that any unavoidable exposure to radiation or contamination of persons or of the environment is below the limits specified by the regulations and is reduced to the minimum that is possible with present science and technology, taking into account all the circumstances of the case.

A. Dosimeter Radex RD 1706

Used for determining dose rates in $\mu\text{Sv/h}$ for β -, γ - and X-rays, this radiation meter can be operated by non-professionals while nonetheless offering the features of a professional dosimeter. Including two built-in Geiger-Müller counter tubes and a large, illuminated LCD display. The device measures the activity of β - and γ -particles and uses the results to calculate the dose rate. Depending on dose rate, the measurement and calculation times vary from 26 s to 1 s at high dose rates. Detection of each particle is indicated by an audio signal to facilitate searching for radioactive sources. The difference between the mean dose rate and background radiation level, as well as the background radiation level itself are displayed in the “background” mode. This facilitates, for example, inspections of enclosed spaces and building materials. Overshoot of an adjustable alarm threshold can be indicated either by an audio signal or a vibration signal. Measured values remain saved after the device has been turned off.

Counters:	Two GM counter tubes SBM20-1
Measurement variable:	Ambient equivalent dose rate $H^*(10)$
Measuring range:	0.05 – 999.0 $\mu\text{Sv/h}$
Alarm threshold:	Adjustable from 0.10 to 99.0 $\mu\text{Sv/h}$
Alarm:	Audio or vibration signal
Measurement and calculation times:	26 s 1 s (at $H^*(10) > 3.5 \mu\text{Sv/h}$)
Value display duration:	Continuous
Energy detection range	
X-radiation and γ -radiation:	0.03 to 3.0 MeV
β -radiation:	0.25 to 3.5 MeV
Batteries:	1.5 V, AAA (1 x or 2 x)
Operating time:	500 h, with 2 batteries (1350 mAh) under normal conditions
Dimensions:	approx. 105x60x26 mm ³
Weight (without batteries):	approx. 90 g

P-1012894

B. Spintharoscope

Detection instrument for observing scintillations produced by radioactive decay. When a radiation cartridge (^{226}Ra , 4 kBq, P-1006797) is screwed into the instrument so that its radiation outlet is directed downwards onto the exposed zinc sulphide screen, it is possible to look through the eyepiece of the instrument in total darkness and observe the random light flashes that are caused by radioactive decay.

Screen: 15x15 mm²

P-1000918

Additionally required:

P-1006797 Radiation Cartridge, ^{226}Ra , 4 kBq

C. Cloud Chamber

Expansion cloud chamber for observing the paths of α -rays. Cover and sidewall are of plexiglas. With threaded hole for inserting the ^{226}Ra , 4 kBq radiation cartridge (P-1006797), hinged absorption foil for opening and closing the beam outlet and carrying handle at the side. By compressing the attached rubber ball and then allowing it to expand, a supersaturated isopropanol–water mixture is produced in the cloud chamber. Following that, the paths of the α -rays revealed by droplet formation are visible for 1 – 2 seconds in the light of an optical lamp.

P-1000921

Additionally required:

P-1006797 Radiation Cartridge, ^{226}Ra , 4 kBq

D. Radiation Cartridge, ^{226}Ra , 4 kBq

Regulation-exempt radiation source with brass container for shielding. Radium sulphate rolled in gold foil and sealed at one end of a stainless steel cartridge.

Activity:	approx. 4 kBq
Tolerance:	-10% / +40%
Weight:	approx. 400 g

P-1006797

Caution: Hazardous item.

For this reason there will be additional transport costs.

Important note: In Germany, the ^{226}Ra radiation cartridge is authorised for unlimited use. Its activity is approximately 4 kBq although it can be up to 40% higher or up to 10% lower. The limit for unlimited use of ^{226}Ra is 10 kBq. The ^{226}Ra radiation cartridge can be used on its own in Germany without any authorisation or notice as long as the so-called “sum rule” is adhered to. Otherwise, it is necessary to obtain authorisation from the appropriate authority. The “sum rule” states that the percentage contribution from all samples or nuclides present must not exceed 100% of the authorised limits. In other countries, it is necessary to observe the legal regulations stipulated there.



P-1008708

P-1008707

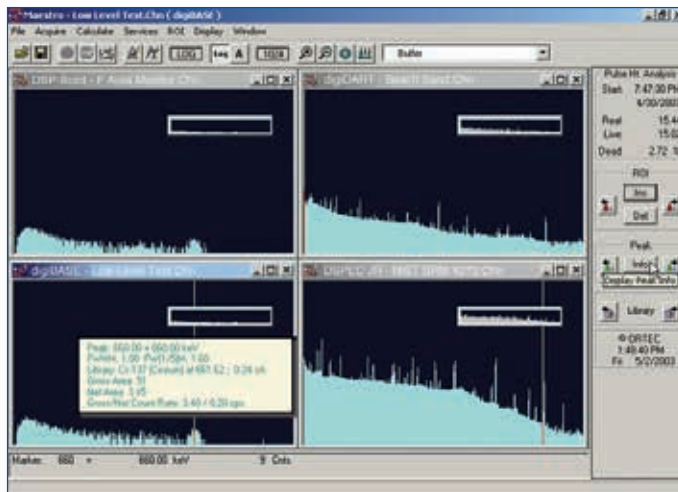

Screenshot of the measurement and evaluation software MAESTRO 32

NaI(Tl) Scintillation Detector

An energy-sensitive detector for identifying γ -ray and X-ray fluorescent radiation with high probability. It can record energy spectra, which can be calibrated, and measure the relative intensity of the radiation. Incoming radiation causes a thallium-doped sodium iodide crystal to emit brief pulses of light, which are then converted into electrical pulses in proportion to the energy of the radiation by means of a photomultiplier affixed to the apparatus. The crystal is protected against light penetrating from outside by a thin aluminium cover. The photomultiplier is protected from interference by external magnetic fields by means of mu-metal shielding.

Relative energy resolution:	8% approx. at 662 keV
Connector socket:	14-pin, with centring aid
Dimensions of crystal :	approx. 51 mm x 51 mm diam.
Aluminium cover:	approx. 0.5 mm
Overall dimensions	approx. 185 mm x 58 mm diam.

P-1008707

Additionally required:

P-1008708 NaI Operating and Evaluation Unit

Additionally recommended:

P-1006797 Radiation Cartridge, ^{226}Ra , 4 kBq

NaI Operating and Evaluation Unit

Complete apparatus for operation and evaluation, designed for measurement and comprehensive evaluation of energy spectra. Consists of a 14-pin connector stage with a high-voltage power supply for the photomultiplier of an NaI(Tl) scintillation detector. Possesses an integrated amplifier with pulse-shaping capability and digital signal processing for four-channel analysis. The power supply for the complete unit is provided via the USB port of a PC. Includes MAESTRO 32 measurement and evaluation software for a PC. The measurement and evaluation software has a versatile graphic user interface, supports identification of the measured radiation energies with the aid of integrated libraries and allows for the setting of all measurement parameters, including the high-voltage supply, from the PC.

Resolution:	1024 channels
Amplification:	1, 3 or 9 (coarse) 0.4 –1.2 (fine)
Integral non-linearity:	<0.05% over 99% of the range
Differential non-linearity:	<1% over 99% of the range
Effect of lag:	<5% for less than 50000 events per second
High-voltage supply:	0 to 1200 V DC
Amplifier drift:	<0.15x10 ⁻³ per °C
Offset drift:	<0.05x10 ⁻³ per °C
Pulse shaping:	0.75 – 2 μ s

P-1008708

Additionally required:

P-1008707 NaI(Tl) Scintillation Detector



Steel Safe for Radioactive Materials

Steel safe with two compartments for theft proof storage of radioactive materials in accordance with radiation protection requirements.

Dimensions:	approx. 140x300x360 mm ³
Weight:	approx. 3 kg

P-1000920



P-1000638
P-1000637

ESR/NMR Basic Set

This basic equipment set is intended for investigating the electron spin resonance (ESR) of an unpaired electron of a DPPH sample as well as the nuclear magnetic resonance (NMR) of glycerine, teflon and polystyrene. Resonances are observed via transitions induced through high frequencies resulting from changes in the external magnetic field. Resonance absorption curves can be represented with a simple dual-channel oscilloscope.

Contents:

- 1 Basic unit
- 1 Pair of coils
- 1 Control panel
- 1 Plug-in power supply, 12 V AC (230 V, 50/60 Hz)
- or
- 1 Plug-in power supply, 12 V AC (115 V, 50/60 Hz)

The basic unit is a mechanical base for test samples as well as ESR (from P-1000640) or NMR probes (from P-1000642), a coil pair and a permanent magnet (from P-1000642).

Dimensions: approx. 165x105x135 mm³
Weight: approx. 1.25 kg

The coil pair is used to generate the variable magnetic field for electron spin resonance and – in conjunction with the permanent magnet (from P-1000642) – nuclear spin resonance.

Magnetic flux density: 0 – 3.7 mT
Connection: Barrel connector
Dimensions: approx. 20 mm x 74 mm diam. each
Weight: approx. 0.2 kg each

The control console provides the voltage for control and supply of power to probes and the coil pair. It also processes the signal for display on an oscilloscope and indicates the frequency of the high-frequency signal.

Probe connection: Four-pin Lemo socket
Coil pair connection: Saw-tooth current source, 0 – 250 mA, 50 ms, pair of barrel sockets
Field output: Proportional to coil current, 0 to 1 V, BNC socket
Signal output: Resonance signal, 0 to 1 V, BNC socket
Frequency range: approx. 45 to 75 MHz (ESR)
approx. 10 to 15 MHz (NMR)
Dimensions: approx. 170x105x45 mm³
Weight: approx. 0.5 kg

Experimental Topics:

- Resonance absorption of a high-frequency oscillating circuit
- Dependence of resonance frequency on magnetic fields
- Line width
- Electron spin
- Magnetic moment of an electron
- Determination of the electron g factor
- Proton spin
- Magnetic moment of a proton and nucleus
- Determination of the nucleus g factor
- Nuclear-spin tomography

ESR/NMR Basic Set (230 V, 50/60 Hz)
P-1000638

ESR/NMR Basic Set (115 V, 50/60 Hz)
P-1000637

Additionally required:
P-1000640 ESR Supplementary Set
or
P-1000642 NMR Supplementary Set
P-1020910 Digital Oscilloscope 2x30 MHz



NMR Supplementary Set

Supplementary set for ESR/NMR basic set (P-1000638 or P-1000637) for experiments on nuclear magnetic resonance using three different samples. Consists of an NMR probe-head with radio frequency coil, a permanent magnet giving a highly uniform field, a sample of glycerine, a sample of polystyrene, a sample of Teflon, an empty sample tube for comparison and two mounting discs.

Connection to the probe-head: Four-pin Lemo plug

Magnetic flux density of permanent magnet: approx. 300 mT

P-1000642

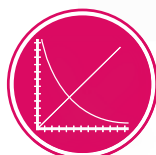

UE5030200
PDF online

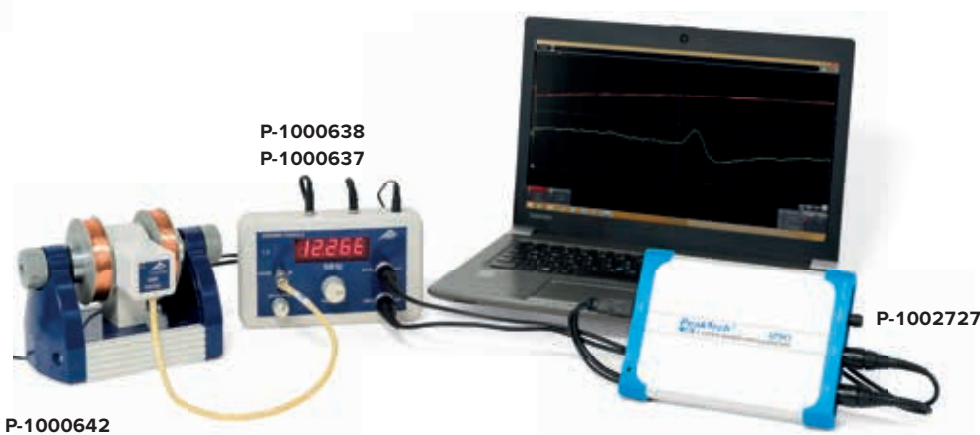

P-1000638
P-1000637

P-1000642

P-1002727



ESR Supplementary Set

Supplementary set for ESR/NMR basic set (P-1000638 or P-1000637) for experiments on electron spin resonance using DPPH. Consists of an ESR probe-head with radio frequency coil, a sample of DPPH (diphenyl picryl hydrazyl), an empty sample tube for comparison, two mounting rings and two mounting cylinders.

Connection to the probe-head: Four-pin Lemo plug

P-1000640

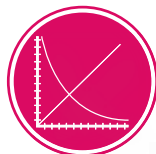

UE5030100
PDF online

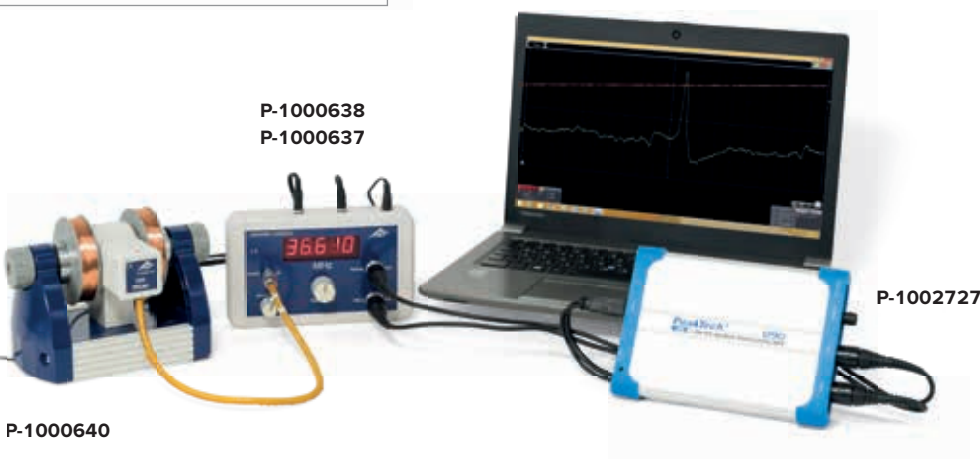

P-1000638
P-1000637

P-1000640

P-1002727

Experiment Topics:

- Hall effect in semiconductors
- Extrinsic conductivity
- Intrinsic conductivity
- Mobility of electrons and holes
- Drift velocity of charge carriers
- Carrier concentration
- Band separation

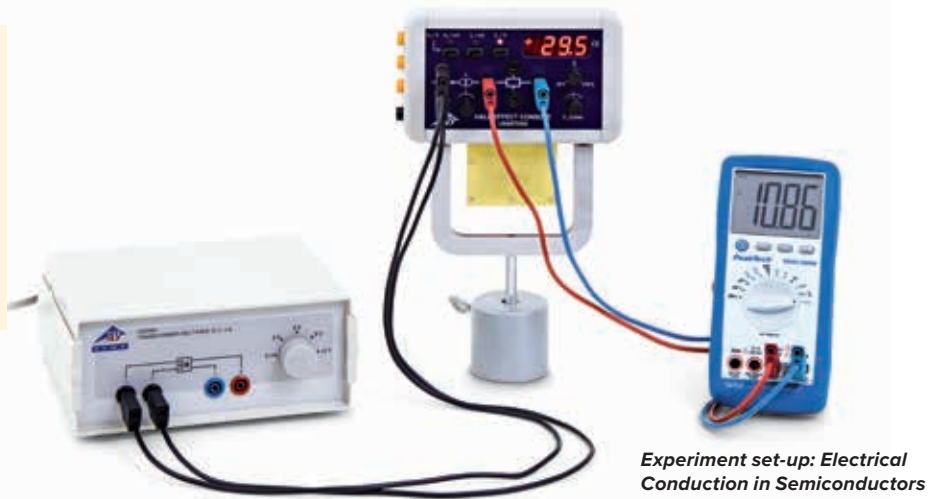

Experiment set-up: Electrical Conduction in Semiconductors

Basic Hall Effect Apparatus

Basic apparatus for providing contact, power supply and support to a germanium crystal on a circuit board (P-1008522, P-1009810 and P-1009760) in experiments on the Hall effect or on conductivity. Includes an integrated, adjustable constant current source to provide the current through the sample, a measuring amplifier with offset compensation for Hall voltages and heating to raise the crystal to as high as 170°C, also featuring temperature regulation and a switchable display showing Hall voltage, sample current, sample voltage or temperature. Hall voltage and sample voltage can be tapped directly from the front panel. In addition three equivalent voltage outputs for Hall voltage, sample current and sample temperature can be measured from the side. Includes an attachment for assembling the apparatus on the U-shaped core (P-1000979) of a transformer assembly kit.

Outputs for

equivalent voltages:

4 mm safety sockets

8-pin miniDIN sockets

Power supply:

12 V AC, 3 A via 4 mm sockets

Dimensions:

approx. 180x110x50 mm³

Weight:

approx. 0,5 kg

P-1009934

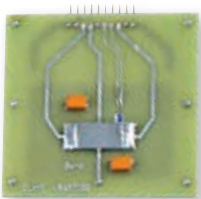

N-Doped Germanium on Printed Circuit Board

High-quality interchangeable board with an n-doped germanium crystal for investigating the conductivity and Hall potential for n-doped germanium as a function of temperature. With contacts for transverse current and Hall potential, integrated resistive heating element with temperature sensor directly under the crystal, and multi pin plug for connecting the circuit board to the basic Hall effect apparatus (P-1009934).

Crystal dimensions: approx. 20x10x1 mm³

Overall dimensions: approx. 70x70x10 mm³

Weight: approx. 30 g

P-1009760

Additionally required:

P-1009934 Basic Hall Effect Apparatus

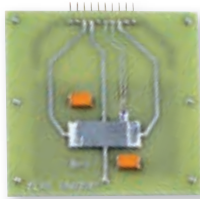

Undoped Germanium on Printed Circuit Board

High-quality interchangeable board with an undoped germanium crystal for investigating the conductivity of undoped germanium as a function of temperature. With contacts for transverse current, integrated resistive heating element with temperature sensor directly under the crystal, and multi pin plug for connecting the circuit board to the basic Hall effect apparatus (P-1009934).

Crystal dimensions: approx. 20x10x1 mm³

Overall dimensions: approx. 70x70x10 mm³

Weight: approx. 30 g

P-1008522

Additionally required:

P-1009934 Basic Hall Effect Apparatus

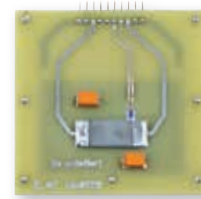

P-Doped Germanium on Printed Circuit Board

High-quality interchangeable board with an p-doped germanium crystal for investigating the conductivity and Hall potential for p-doped germanium as a function of temperature. With contacts for transverse current and Hall potential, integrated resistive heating element with temperature sensor directly under the crystal and multi pin plug for connecting the circuit board to the basic Hall effect apparatus (P-1009934).

Crystal dimensions: approx. 20x10x1 mm³

Overall dimensions: approx. 70x70x10 mm³

Weight: approx. 30 g

P-1009810

Additionally required:

P-1009934 Basic Hall Effect Apparatus

Experiment “Electrical Conduction in Semiconductors – Determine band separation in germanium”

- | | |
|---|-----------|
| 1 Basic Hall Effect Apparatus | P-1009934 |
| 1 Undoped Germanium on Printed Circuit Board | P-1008522 |
| 1 Barrel Foot, 1000 g | P-1002834 |
| 1 Transformer with Rectifier 3/ 6/ 9/12 V, 3 A
(230 V, 50/60 Hz) | P-1003316 |
| or | |
| 1 Transformer with Rectifier 3/ 6/ 9/12 V, 3 A
(115 V, 50/60 Hz) | P-1003315 |
| 1 Digital Multimeter P3340 | P-1002785 |
| 1 Pair of Safety Experiment Leads, 75 cm | P-1002849 |
| 1 Pair of Safety Experiment Leads, 75 cm, red/blue | P-1017718 |

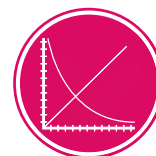
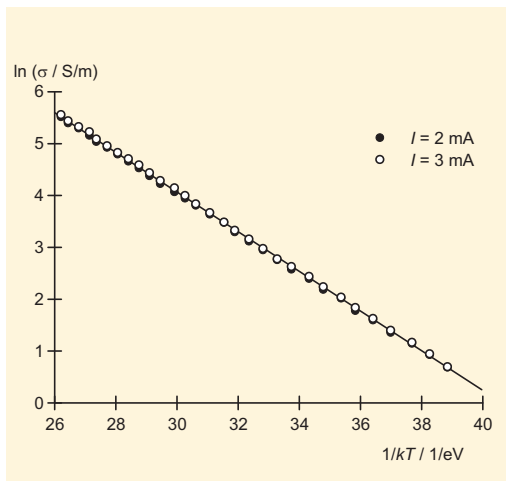

UE6020100
PDF online

Comparison between conductivities of pure and doped germanium.

Experiment “Hall-effect in p- and n-doped germanium”

- | | |
|---|-----------|
| 1 Basic Hall Effect Apparatus | P-1009934 |
| 1 N-Doped Germanium on Printed Circuit Board | P-1009760 |
| 1 P-Doped Germanium on Printed Circuit Board | P-1009810 |
| 1 Magnetic Field Sensor FW ±2000 mT | P-1021766 |
| 1 Coil D with 600 turns | P-1000988 |
| 1 U-core | P-1000979 |
| 1 Pair of Pole Shoes and Clamping Brackets D for Hall Effect | P-1009935 |
| 1 Transformer with Rectifier 3/ 6/ 9/12 V, 3 A
(230 V, 50/60 Hz) | P-1003316 |
| or | |
| 1 Transformer with Rectifier 3/ 6/ 9/12 V, 3 A
(115 V, 50/60 Hz) | P-1003315 |
| 1 DC Power Supply 0 – 20 V, 0 – 5 A (230 V, 50/60 Hz) | P-1003312 |
| or | |
| 1 DC Power Supply 0 – 20 V, 0 – 5 A (115 V, 50/60 Hz) | P-1003311 |
| 1 Digital Multimeter P3340 | P-1002785 |
| 1 Set 15 Safety Experiment Leads 75 cm | P-1002843 |
| 1 VinciLab | P-1021477 |
| 1 Software Coach 7 | |

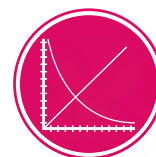
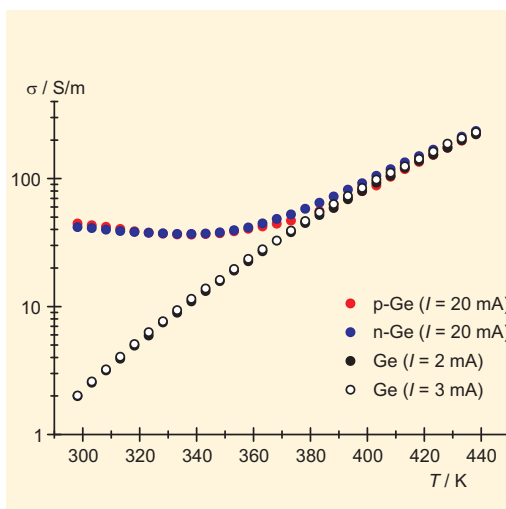

UE6020200
PDF online

Hall voltage in p- and n-doped germanium as a function of the temperature T

Experiment set-up: Hall-Effect in Semiconductors



Experiment Topics:

- Hall effect in metals
- Normal and anomalous Hall effect
- Hall coefficient

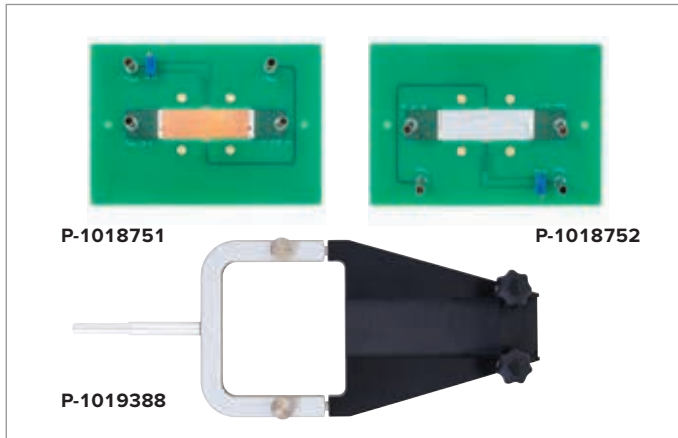

Hall Effect in Metals

For verifying the existence of a Hall-effect voltage across a copper or zinc sample being supplied with a current I and located in a magnetic field acting perpendicular to the direction of the current. Ready-to-use samples are soldered onto a printed circuit board with 4-mm connection sockets. The combined holder for Hall effect is required in order to attach the sample within the magnetic field of an electromagnet.

Thickness of copper sample:	17.5 μm
Max. current through copper sample:	20 A DC
Thickness of zinc sample:	25 μm
Max. current through zinc sample:	15 A DC
Sample surface area:	10x44 mm ²
Dimensions:	approx. 130x90x25 mm ³
Weight:	approx. 45 g

Copper Sample for Hall Effect

P-1018751

Zinc Sample for Hall Effect

P-1018752

Combined Holder for Hall Effect

P-1019388

Required to generate magnetic field:

P-1000988 Coil D with 600 Turns (2x)

P-1000979 U Core D

P-1009935 Pair of Pole Shoes and Clamping Brackets D for Hall Effect

P-1003312 DC-Power Supply 0 – 20 V, 0 – 5 A (230 V, 50/60 Hz)

or

P-1003311 DC-Power Supply 0 – 20 V, 0 – 5 A (115 V, 50/60 Hz)

Additionally required:

P-1002771 DC Power Supply 0–16 V, 0–16 A

P-1020742 Measurement Amplifier U (230 V, 50/60 Hz)

or

P-1020744 Measurement Amplifier U (115 V, 50/60 Hz)

P-1002781 Digital Multimeter P1035

P-1008537 Teslameter E

P-1012892 Flexible Magnetic Field Sensor

P-1002843 Set of 15 Safety Experiment Leads, 75 cm



P-1020742
P-1020744

Measurement Amplifier U

Measurement amplifier U amplifies low-amplitude measurement signals from low-resistance signal sources for measurement with any chosen voltmeter or oscilloscope. By using an external shunt resistor it is also possible to measure small currents. Offset voltages can be compensated using coarse and fine offset adjustment knobs. Amplification (gain) can be selected in ranges from 0 to 5 powers of ten. High-frequency noise or other interference signals are filtered out by means of a low-pass filter with step-wise selectable time constants between 0 and 3 seconds. The output voltage has the same sign as the input voltage.

Input resistance:	10 k Ω
Output resistance:	300 Ω
Offset voltage drift:	< 2 $\mu\text{V/K}$ (after 15 mins. operation approx.)
Gain factors:	10 ⁰ ; 10 ¹ ; 10 ² ; 10 ³ ; 10 ⁴ ; 10 ⁵
Tolerance for gain factors:	< 2.5 %
Input voltage:	max. ± 12 V (overload protected for brief transients up to 100 V)
Output voltage:	0 ... ± 12 V (short-circuit protected)
Power supply (via plug-in supply provided):	12 V AC
Ambient temperature:	5°C ... 23°C ... 40°C
Storage temperature:	-20 ... 70°C
Relative humidity:	<85% no condensation
Operational alignment:	Horizontal
Contamination level:	2
Protection class:	IP20
Dimensions:	approx. 170x105x50 mm ³
Weight:	approx. 335 g

Measurement Amplifier U (230 V, 50/60 Hz)

P-1020742

Measurement Amplifier U (115 V, 50/60 Hz)

P-1020744

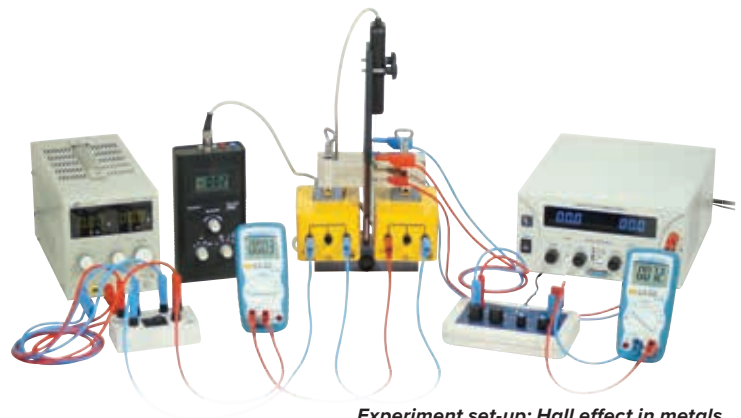

Experiment set-up: Hall effect in metals

As early as 1790 the Bolognese researcher Luigi Galvani had demonstrated on the leg of a frog that electrical processes were involved in the functioning of nerves and muscles. Even today, similar specimens are used for research into nerve function and muscle contraction. One alternative to this is to carry out experiments on a live earthworm. In contrast to using conventional frog specimens, this offers a number of advantages:

- It is not necessary to kill any animals. The worm remains unharmed.
- Difficult and time-consuming preparation of a creature is not necessary.
- The nerves of the earthworm have a simpler structure than those of the frog, thus allowing measurement of the nerve impulses in individual nerve fibres.
- The function of nerve potentials for the reflexes exhibited by the intact worm can be demonstrated.
- Cellular mechanisms for habituation can be measured.

Experiment Topics:

- Tactile stimulation of an earthworm
- Electrical stimulation of an earthworm
- Single-channel recording
- Two-channel recording
- Electrocardiogram

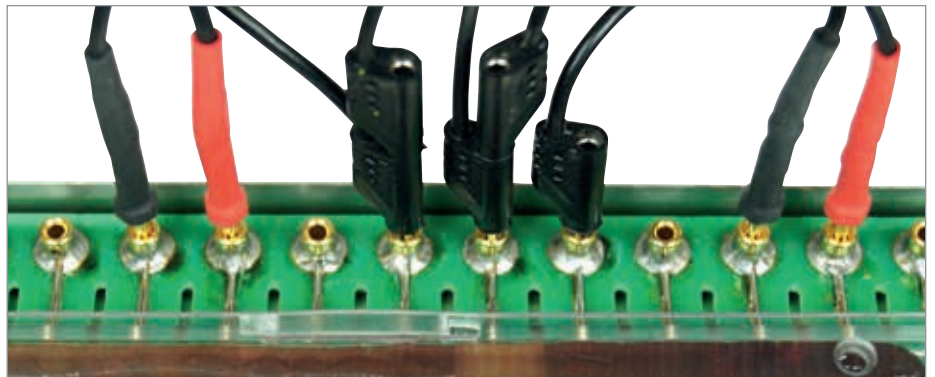

Neurophysiological studies with electrical stimulation of an earthworm

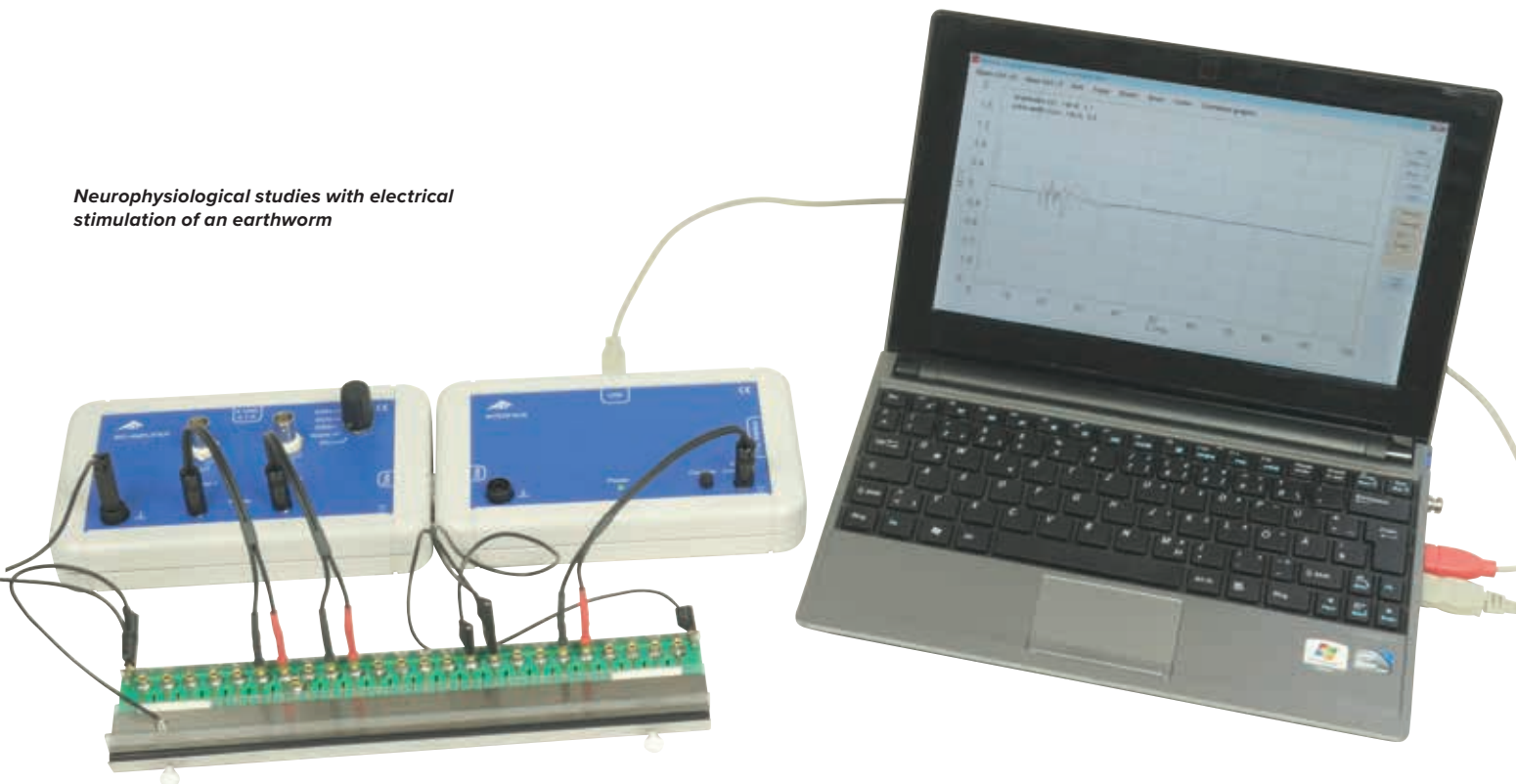

Measurement Chamber for Earthworm Experiments

The measurement chamber for earthworm experiments is used in neurophysiological experiments on intact worms. This involves stimulation of the worm by electrical or tactile means and measurement of its action potential. Worms remain uninjured and can be returned to their habitat after completion of the experiment.

A cover with holes drilled in it allows worms to be secured transversely across the apparatus without difficulty and two replaceable longitudinal securing mechanisms prevent them moving along. Contact with the worms is via a long line of electrodes which can be connected to the bio-amplifier via 2-mm sockets and special cables or to the stimulus generator of the bio-measurement interface. Tactile stimuli can be provoked through the hole in the cover. The measurement chamber can be quickly and easily dismantled after completion of the experiments.

Connectors: 2-mm sockets
Dimensions: approx. 250x55x20 mm³
Weight: approx. 192 g

Contents:

- 1 Measurement chamber
- 1 Adapter cable (2-mm / 4-mm plugs)
- 1 Magnet cable
- 3 Connecting leads (2-mm plugs)
- 3 Measuring leads (2-mm plugs/3.5-mm jack plugs)

P-1020601

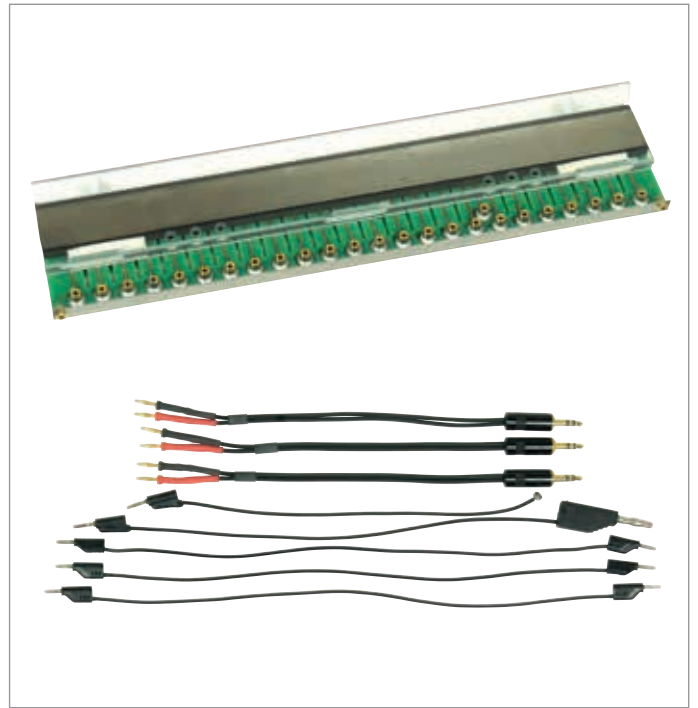

Stimulation Equipment for Earthworm Experiments

The stimulation equipment is for tactile stimulation of earthworms in neurophysiological experiments. A pin falling from a specific height creates a stimulus such as that likely to occur to a worm in nature. This stimulates potential for action in the nerves of the worm. It is possible to detect a relationship between the twitching reflex and the relevant nerves as well as the potential in the muscles. The creature remains uninjured and can be returned to its habitat after completion of the experiment.

The stimulation equipment is connected to the bio-measurement interface. Results of the experiment are communicated to a computer via the interface and displayed by means of the accompanying software. Recording of the resulting signal is also activated by the software.

Power supply: +5 V DC (via Sub-D plug connector)
Mass of falling pin: 1 g
Dimensions of pin (3 pins): 40 mm x 2 mm diam.
Scale intervals: 1 cm
Plug: Sub-D, 15-pin
Dimensions: approx. 125x15x15 mm³
Weight: approx. 75 g

P-1020603

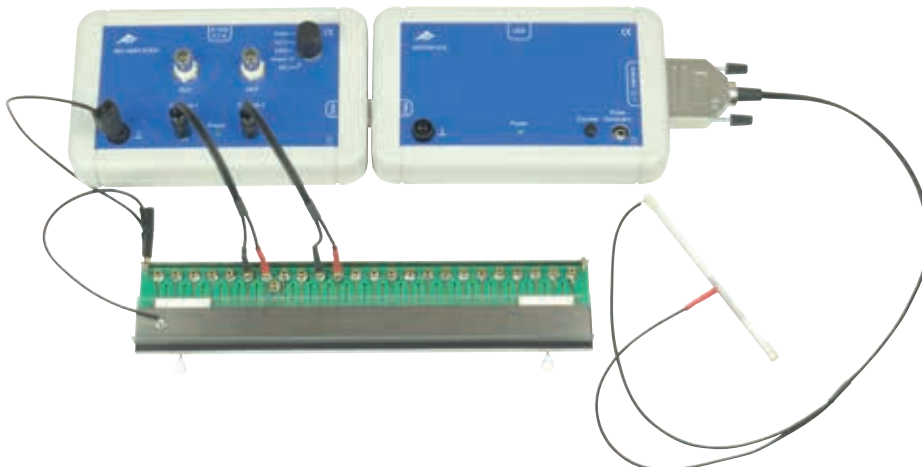

Neurophysiological studies with tactile stimulation of an earthworm



Bio-Measurement Interface

The bio-measurement interface is for measurement and control in electro-physiological experiments with the bio-amplifier. It operates in conjunction with a computer via a serial USB interface. Driver and measurement software are included with the equipment.

There is also a built-in floating, software-controlled pulse generator, which acts as a stimulus generator in conjunction with the measurement chamber for experiments on earthworms (P-1020601). The measurement software outputs square pulses of variable amplitude and pulse width, which can be used as single pulses or double pulses with varying intervals.

Power supply: +5 V, max. 200 mA via USB port
 USB port: Type B socket
 Connector for bio-amplifier: Sub-D plug, 15-pin
 Connector for measurement modules and sensors: Sub-D socket, 15-pin
 Output for stimulus generator: 3.5-mm jack socket
 Dimensions: approx. 175x105x30 mm³
 Weight: approx. 335 g

P-1020602



Bio-Amplifier

Two-channel amplifier for electro-physiological experiments. The amplified signals from both channels can be displayed on a storage oscilloscope or with the help of the Bio-measurement interface connected to a computer. Gain and frequency response are dependent on the selected experiment: action and muscle potentials in live earthworms (Worm), electro-retinograms (ERG), electrocardiograms (ECG), electromyograms (EMG).

Measuring ranges: max. ± 1 mV (worm), max. ± 10 mV (ECG, EMG, ERG)
 Frequency ranges: 120 – 1800 Hz (worm) 0.5 – 1800 Hz (ERG, EMG)
 0.5 – 30 Hz (ECG)
 Power supply: 5 V DC / 100 mA via plug-in power supply or bio-measurement interface (P-1020602)

Connector for bio-measurement interface: Sub-D socket, 15-pin
 Connector for oscilloscope: BNC socket
 Connector for measurement chamber: 3.5-mm jack socket
 Dimensions: approx. 175x105x30 mm³
 Weight: approx. 335 g

Bio-Amplifier (230 V, 50/60 Hz)
P-1020599

Bio-Amplifier (115 V, 50/60 Hz)
P-1020600

> Electro cardiogram



Connecting Cable for Electro Cardiograms

Special cable for recording electrocardiograms and electromyograms.

Connectors: measurement electrodes/3.5-mm jack plugs

P-1020605

Additionally required:

P-5006578 Set of 30 Electrodes for ECG/EMG

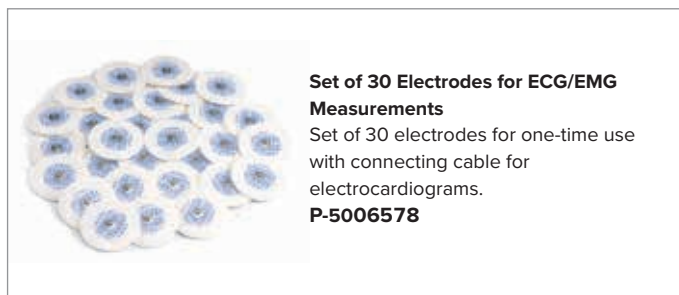

Set of 30 Electrodes for ECG/EMG Measurements

Set of 30 electrodes for one-time use with connecting cable for electrocardiograms.

P-5006578

Recording of an electrocardiogram



INSTRUMENTATION



Transformer 12 V, 25 VA

Simple transformer for student exercises. With connection leads and two cascadable 4 mm safety plugs.

- Safety extra-low voltage (SELV) and functional extra-low voltage (FELV)
- Safety transformer conforming to EN 61558-2-6
- Safe isolation between power supply and output circuits

Output: 12 V AC, max. 2 A
 Dimensions: approx. 110x95x65 mm³
 Weight: approx. 0.64 kg

Transformer 12 V, 25 VA (230 V, 50/60 Hz)
P-1000866

Transformer 12 V, 25 VA (115 V, 50/60 Hz)
P-1000865



Plug In Power Supply 24 V, 700 mA

Plug in 24 V power supply for the operation of a Pohl torsion pendulum (P-1002956). With 2 m lead and two stackable 4 mm safety plugs.

Output: 24 V AC, max. 700 mA

Plug In Power Supply 24 V, 700 mA (230 V, 50/60 Hz)
P-1000681

Plug In Power Supply 24 V, 700 mA (115 V, 50/60 Hz)
P-1000680

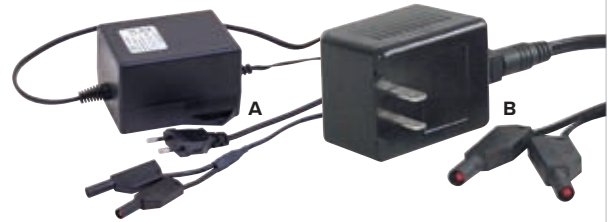

UK Adaptors Included

Power Supply for Optical Lamps

Powerful electronic power supply, e.g. for the operation of lamps as used in optics. Short circuit proof, with connection leads and two cascadable 4 mm safety plugs.

Output: 12 V AC, max. 5 A

A. Transformer 12 V, 60 VA (230 V, 50/60 Hz)

- Safety extra-low voltage (SELV) and functional extra-low voltage (FELV)
- Safety transformer conforming to EN 61558-2-6
- Safe isolation between power supply and output circuits

Dimensions: approx. 95x80x60 mm³

P-1020595

B. Transformer 12 V, 60 VA (115 V, 50/60 Hz)

Dimensions: approx. 75x45x45 mm³

P-1006780



Plug-In Power Supply, 12 V AC

Plug-in power supply with co-axial power connector.

- Safety extra-low voltage (SELV) and functional extra-low voltage (FELV)
- Safety transformer conforming to EN 61558-2-6
- Safe isolation between power supply and output circuits

Art. No.	Voltage	Max. current	Power Connector	Mains voltage
C. P-1012900	12 V AC	2000 mA	5.5x2.5 mm	230 V, 50/60 Hz
D. P-1012899	12 V AC	2000 mA	5.5x2.5 mm	115 V, 50/60 Hz
E. P-1001014	12 V AC	750 mA	5.5x2.1 mm	230 V, 50/60 Hz
F. P-1009545	12 V AC	500 mA	5.5x2.1 mm	115 V, 50/60 Hz



Voltage Regulating Transformer (230 V, 50/60 Hz)

High performance voltage regulating transformer with high load capacity and continuously adjustable AC output voltage. Two digital rms displays for current strength and output voltage. Thermally protected against overload with an overcurrent circuit breaker. Output electrically isolated from mains input.

Output: 0 – 260 V AC, max. 3 A
 Overload protection: Thermal
 Display: 3 digit LCD
 Connection: earthed socket outlet
 Power: 780 VA
 Voltage supply: 230 V \pm 10% 50/60 Hz
 Dimensions: approx. 250x235x178 mm³
 Weight: approx. 20 kg

P-1002772



➤ Refer also to page 136

Table-Top Power Supply

Table-top power supply for supply of power to the heat conduction equipment set.

Mains voltage: 100 – 240 V AC/1 A, 50/60 Hz
 Output voltage: 12 V DC/4 A

P-1017579



Transformer with Rectifier 2/ 4/ 6/ 8/ 10/ 12/ 14 V, 5 A

Safety isolating transformer with safety cut out contained in metal housing. Output voltage switchable in 7 steps

- Safety extra-low voltage (SELV) and functional extra-low voltage (FELV)
- Safety transformer conforming to EN 61558-2-6
- Safe isolation between power supply and output circuits

AC output: 2/ 4/ 6/ 8/ 10/ 12/ 14 V, max. 5 A
 DC output: 2/ 4/ 6/ 8/ 10/ 12/ 14 V, max. 5 A
 Terminals: 4 mm safety sockets
 Dimensions: approx. 260x140x130 mm³
 Weight: approx. 3.1 kg

Transformer with Rectifier 2/ 4/ 6/ 8/ 10/ 12/ 14 V, 5 A (230 V, 50/60 Hz) P-1003558

Transformer with Rectifier 2/ 4/ 6/ 8/ 10/ 12/ 14 V, 5 A (115 V, 50/60 Hz) P-1003557

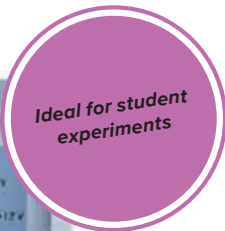

Transformer with Rectifier 3/ 6/ 9/ 12 V, 3 A

Extra low voltage power supply with overload protection contained in plastic housing. Output voltage switchable in four stages.

- Safety extra-low voltage (SELV) and functional extra-low voltage (FELV)
- Safety transformer conforming to EN 61558-2-6
- Safe isolation between power supply and output circuits

AC output: 3/ 6/ 9/ 12 V, max. 3 A
 DC output: 3/ 6/ 9/ 12 V, max. 3 A
 Terminals: 4 mm safety sockets
 Dimensions: approx. 210x170x90 mm³
 Weight: approx. 2.6 kg

Transformer with Rectifier 3/ 6/ 9/ 12 V, 3 A (230 V, 50/60 Hz) P-1003316

Transformer with Rectifier 3/ 6/ 9/ 12 V, 3 A (115 V, 50/60 Hz) P-1003315



AC/DC Power Supply 0 – 12 V, 3 A

Extra low voltage power supply with continuously adjustable, stabilised and regulated DC output voltage. DC voltage output is short circuit proof and noise voltage proof. Three AC outputs galvanically isolated from the DC voltage outputs are overload protected via semiconductor fuses (multifuses).

- Safety extra-low voltage (SELV) and functional extra-low voltage (FELV)
- Safety transformer conforming to EN 61558-2-6
- Safe isolation between power supply and output circuits

DC output: 0 – 12 V, max. 3 A
 AC outputs: 3 / 6 / 9* / 12 V, max. 3 A (*differential)
 Output power: max. 36 W
 Stability under full load: ≤ 50 mV
 Residual ripple under full load: ≤ 10 mV_{pp}
 Terminals: 4 mm safety sockets

**AC/DC Power Supply 0 – 12 V, 3 A (230 V, 50/60 Hz)
 P-1021091**

**AC/DC Power Supply 0 – 12 V, 3 A (115 V, 50/60 Hz)
 P-1021092**



AC/DC Power Supply 0 – 12 V, 3 A, stab.

Extra low voltage power supply with continuously adjustable, stabilised DC voltage or stabilised AC voltage. Selection between DC and AC output voltage is performed using a toggle switch.

DC output: 0 – 12 V, max. 3 A, stabilised
 AC output: 0 – 12 V, max. 3 A, stabilised
 Dimensions: approx. 160x170x65 mm³
 Weight: approx. 2.9 kg

**AC/DC Power Supply 0 – 12 V, 3 A, stab. (230 V, 50/60 Hz)
 P-1001007**

**AC/DC Power Supply 0 – 12 V, 3 A, stab. (115 V, 50/60 Hz)
 P-1001006**



AC/DC Power Supply 0 – 30 V, 5 A (230 V, 50/60 Hz)

Continuously adjustable AC/DC power supply unit with digital displays for voltage and current readings, particularly suitable for experiments for students and trainees. The outputs are galvanically isolated. A pushbutton can be used to turn the capacitor filtration of the output direct voltage on and off (smoothing). In the event of an overload, the device is turned off by a thermal overload protection switch.

DC output: 0 – 30 V, max. 5 A
 AC output: 0 – 30 V, max. 5 A
 Max. output power: 150 VA
 Display: 2x 3 digit LED
 Digit height: 15 mm
 Connections: 4 mm jacks
 Voltage supply: 230 V ±10% 50/60 Hz
 Dimensions: approx. 280x205x140 mm³
 Weight: approx. 8.3 kg

P-1002769



AC/DC Power Supply 0 – 20 V, 0 – 5 A (230 V, 50/60 Hz)

Power supply with adjustable and stabilised DC voltage and analogue voltage and current display for DC voltage. The DC voltage component features an automatically alternating voltage and current control and is protected against continuous short circuits. The AC voltage can be selected in eight steps, the output is protected by an overcurrent circuit breaker. The AC and DC voltage outputs are DC isolated. A temperature regulated fan protects the unit from overheating.

- Safety extra-low voltage (SELV) and functional extra-low voltage (FELV)
- Safety transformer conforming to EN 61558-2-6
- Safe isolation between power supply and output circuits

DC output: 0 – 20 V, 0 – 5 A
 AC output: 2, 4, 6, 8, 10, 12, 15, 20 V, max. 5 A
 Ripple U: <10 mV
 Dimensions: approx. 235x175x245 mm³
 Weight: approx. 8 kg

P-1003562



AC/DC Power Supply 1/ 2/ 3/...15 V, 10 A (230 V, 50/60 Hz)

AC and DC power supply adjustable to various levels and housed in metal case. Particularly suitable for experiments by pupils and for lab practicals. Features stabilised DC voltages. Outputs are galvanically isolated and short-circuit-proof.

DC output: 1/ 2/ 3/ 4/ 5/ 6/ 7/ 8/ 9/ 10/ 11/ 12/ 13/ 14/ 15 V, max. 10 A
 AC output: 1/ 2/ 3/ 4/ 5/ 6/ 7/ 8/ 9/ 10/ 11/ 12/ 13/ 14/ 15 V, max. 10 A
 Max. output power: 150 VA
 Connections: 4 mm jacks
 Dimensions: approx. 170x160x250 mm³
 Weight: approx. 6.3 kg

P-1008691



Usable as a current source

AC/DC Power Supply, 0 – 30 V, 0 – 6 A

Combined power supply with separate AC and DC outputs plus separate displays of output voltage and current. The DC output can be used as a voltage source or current source and can be set to any value within its range. The AC output features current limiting and is electronically protected against overload.

DC voltage: 0...30 V
 DC current: 0...6 A
 AC voltage: 0...30 V
 AC current: max. 6 A
 Dimensions: approx. 380x140x300 mm³
 Weight: approx. 12 kg

AC/DC Power Supply 0 – 30 V, 0 – 6 A (230 V, 50/60 Hz)

P-1003593

AC/DC Power Supply 0 – 30 V, 0 – 6 A (115 V, 50/60 Hz)

P-1008692



with current limiting

DC Power Supply 450 V

Power supply with three outputs for the electric supply in experiments with the Electrometer (P-1001025 resp. P-1001024).

- Current limiting to protect against contact with high voltages
- Safety transformer conforming to EN 61558-2-6
- Safe isolation between power supply and output circuits

Output 1:

Voltage: 0 – 450 V DC
 Max. current: 10 μ A

Output 2:

Voltage: 1.2 – 12 V DC
 Max. current: 100 mA

Output 3:

Voltage: 0 – 12 V AC
 Max. current: 10 mA

Dimensions: approx. 250x100x160 mm³
 Weight: approx. 0.8 kg

DC Power Supply 450 V

(230 V, 50/60 Hz)

P-1008535

DC Power Supply 450 V

(115 V, 50/60 Hz)

P-1008534



DC Power Supply 1.5 – 15 V, 1.5 A (230 V, 50/60 Hz)

Handy DC power supply contained in a sturdy metal housing. The output voltage is continuously adjustable and is displayed via an analogue measuring instrument. The output is short circuit proof and floating.

- Safety extra-low voltage (SELV) and functional extra-low voltage (FELV)
- Safety transformer conforming to EN 61558-2-6
- Safe isolation between power supply and output circuits

Output voltage: 1.5 – 15 V, max. 1.5 A
 Residual ripple: 10 mV
 Terminals: 4 mm safety sockets
 Voltage supply: 230 V \pm 10% 50/60 Hz
 Dimensions: approx. 100x80x150 mm³
 Weight: approx. 2 kg

P-1003560

DC Power Supply 0 – 500 V

Low voltage power supply with four outputs primarily intended to supply power for electron tubes and Helmholtz coils simultaneously, with four independently adjustable DC voltages and analogue dials for each of them. The DC voltages are stabilised and regulated, floating and galvanically isolated from one another, short circuit proof and secure from external voltages.

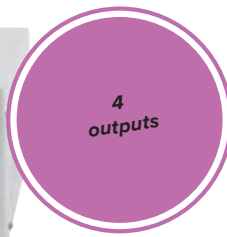

500 V output:

Voltage: 0 – 500 V DC, max. 50 mA
 Stability at full load: $\leq 0.01\% \pm 100$ mV
 Residual ripple: ≤ 20 mV

50 V output:

Voltage: 0 – 50 V DC, max. 50 mA
 Stability at full load: $\leq 0.1\% \pm 30$ mV
 Residual ripple: ≤ 50 mV

8 V output:

Voltage: 0 – 8 V DC, max. 3 A
 Stability at full load: $\leq 0.1\% \pm 30$ mV

12 V output:

Voltage: 0 – 12 V DC, max. 4 A
 Stability at full load: $\leq 0.1\% \pm 30$ mV

Displays: Analogue, class 2
 Connections: 4 mm safety sockets
 Power consumption: 50 VA
 Dimensions: approx. 85x325x190 mm³
 Weight: approx. 4 kg

DC Power Supply 0 – 500 V (230 V, 50/60 Hz) P-1003308

DC Power Supply 0 – 500 V (115 V, 50/60 Hz) P-1003307



DC Power Supply, 1 – 32 V, 0 – 20 A (230 V, 50/60 Hz)

High-quality switched-mode power supply in space-saving housing with intelligent control of fan speed to ensure safe and quiet operation. Simple, precise and fast adjustment of voltage and current levels with dual-function rotary knobs for coarse and fine adjustment. Adjustable current limiting in open circuit. Three user-definable stored configurations for voltage and current limiting make it easy to recall frequently used settings. Full remote control of voltage and current plus output which can be turned on and off.

Display: 3-digit, 15 mm, green LED
 Output voltage: 1 – 32 V DC
 Output current: 0 – 20 A (output with pole terminals on rear)
 0 – 5 A (output with 4-mm safety sockets on front)

Max. power output: 640 W
 Residual ripple: 5 mV rms
 Efficiency: > 87.0 %
 Dimensions: approx. 200x90x255 mm³
 Weight: approx. 2.6 kg

P-1012857

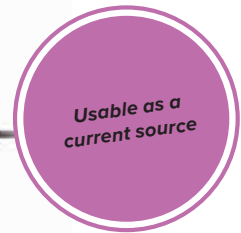

DC Power Supply 0 – 20 V, 0 – 5 A

Universal power supply with digital current and voltage display. Output voltage and output current are continuously adjustable. The device can be used as a constant voltage source with current limiting or as a constant current source with voltage limiting.

DC output: 0 – 20 V, 0 – 5 A
 Output power: 100 W
 Stability under full load: $\leq 0.01\% + 5$ mV, $\leq 0.2\% + 5$ mA
 Residual ripple ≤ 1 mV, 3 mA
 Display: 2x 3 digit LED
 Terminals: 4 mm safety sockets
 Dimensions: approx. 130x150x300 mm³
 Weight: approx. 4.7 kg

DC Power Supply 0 – 20 V, 0 – 5 A (230 V, 50/60 Hz) P-1003312

DC Power Supply 0 – 20 V, 0 – 5 A (115 V, 50/60 Hz) P-1003311

DC Power Supply 0 – 16 V, 0 – 20 A

DC high current power supply with digital display of voltage and current. The voltage and current are continuously adjustable by means of coarse and fine controllers. The device can be used as a constant voltage source with current limiting, or a constant current source with voltage limiting. The selected operating mode is indicated by an LED on the front panel. High reliability even under extremely adverse conditions is ensured by automatic transformer switchover, MOSFET power amplifiers and temperature controlled fan speed with monitoring function. This equipment is also provided with a preset function for protecting against excess current and voltage. The design of the device omits any air vents at the top or bottom and does not require an external heat sink. The output is protected against sustained short circuits. Two or more such units can be operated in series or in parallel.

DC output: 0 – 16 V, 0 – 20 A
 Fine adjustment range U: 800 mV
 Stability at 0 – 100% load: <12 mV
 Residual ripple: <1 mV
 Fine-adjustment range I: 2 A
 Connections: 4 mm jacks
 Mains connection: 115 V/230 V, 50/60 Hz
 Dimensions: approx. 240x120x300 mm³
 Weight: approx. 10 kg

P-1002771

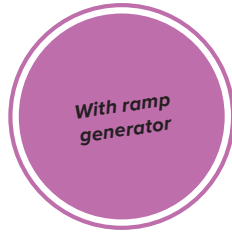

DC Power Supply 0 – 300 V (230 V, 50/60 Hz)

Low voltage power supply for operating tubes. In addition, a ramp generator is available for experiments on the law of induction and the charging and discharging of capacitors.

Outputs: 0 – 300 V DC, max. 200 mA/
0 – -50 V DC, max. 10 mA/
4 – 12 V DC, max. 400 mA

Ramp generator: 2.5 – 50 V/s, linear rising or falling

Operating voltage: 230/115 V AC, 50 (60) Hz

Connections: 4 mm safety sockets

Dimensions: approx. 240x230x170 mm³

Weight: approx. 3.7 kg

P-1001012



High-Voltage Power Supply 10 kV

Universally applicable, floating high-voltage source for experiments on electrostatics or for operating electron tubes. With built-in transformer resistance to external voltage to provide the heating voltage for electron tubes. Continuously adjustable high-voltage source, which is safe to touch, with passive current limiting and digital voltage display.

- Current limiting to protect against contact with high voltages
- Safety transformer conforming to EN 61558-2-6 Safe isolation between power supply and output circuits

High-voltage output: 0 – 10000 V DC, max. 2 mA, floating

Heater voltage output: 6.3 V AC, max. 3 A, resistance to voltage up to 10 kV

Overload protection: Primary fuse: slow-blow 115 V: 2x 1 A, 230 V: 2x 0.5 A

Secondary protection: current-limiting resistors

Dimensions: approx. 240x220x90 mm³

Weight: approx. 2.1 kg

High-Voltage Power Supply 10 kV

(230 V, 50/60 Hz)

P-1019234

High-Voltage Power Supply 10 kV

(115 V, 50/60 Hz)

P-1020138



Ideal for operation of numerous electron tubes (cf. pages 232 ff)

- Regulated high-voltage output not dependent on mains voltage
- High-voltage-proof supply for heater voltage

High Voltage Power Supply 5 kV

Universally applicable, floating, high-voltage source for operation of electron tubes. With built in, high voltage resistant transformer to supply the heater voltage for electron tubes. Continuously adjustable high voltage, safe to touch, with passive current limitation and analogue voltage display.

High voltage output: 0 – -5000 V DC, max. 2 mA, max. 5 W

Heater voltage output: 6.3 V AC, max. 3 A, high voltage resistant up to 5 kV

Overload protection: Primary: fuse
Secondary: current-limiting resistors

Connections: 4 mm safety sockets

High-voltage display: Analogue

Dimensions: approx. 235x130x155 mm³

Weight: approx. 3.5 kg

High Voltage Power Supply 5 kV

(230 V, 50/60 Hz)

P-1003310

High Voltage Power Supply 5 kV

(115 V, 50/60 Hz)

P-1003309



Ideal for operation of numerous electron tubes (cf. pages 232 ff)

- Very high-quality and extremely lightweight equipment in modern casing
- 3-digit digital display for high voltage
- Regulated high-voltage output not dependent on mains voltage
- High-voltage-proof supply for heater voltage
- No need to change fuses

High-Voltage Power Supply E 5 kV

Universally applicable, floating high-voltage source for electrostatic experiments and for operating spectral tubes, gas discharge tubes and electron tubes. With built-in transformer resistance to external voltage to provide the heating voltage for electron tubes. Continuously adjustable high-voltage source, which is safe to touch, with passive current limiting and digital voltage display.

- Current limiting to protect against contact with high voltages

- Safety transformer conforming to EN 61558-2-6

- Safe isolation between power supply and output circuits

High-voltage output: 0 – 5000 V DC, max. 2 mA, floating

Heater voltage output: 6.3 V AC, max. 3 A, resistance to voltage up to 5 kV

Overload protection: Reversible fuse, 3 A

Connectors: 4-mm safety sockets

Power consumption: 35 VA

High-voltage display: 3-digit LED

Dimensions: approx. 240x220x90 mm³

Weight: approx. 2 kg

High-Voltage Power Supply E 5 kV

(230 V, 50/60 Hz)

P-1013412

High-Voltage Power Supply E 5 kV

(115 V, 50/60 Hz)

P-1017725



Ideal for introductory student experiments



Advantages:

- Easy and accurate adjustment
- With built-in continuous sweep-mode
- Ideal for recording resonance curves

FG 100 Function Generator

Function generator with power amplifier for use in versatile student and practical experiments covering simple harmonic oscillation, AC electricity and induction. Featuring illuminated, digital display for frequency, signal form, offset and other parameters. The output is short-circuit protected as well as being protected against induced voltages and spark discharges, e.g. for when experiment leads are unintentionally pulled out while coils are connected. In internal sweep mode, one trigger pulse is output per cycle and the voltage output is proportional to the frequency. With retractable feet. Includes power supply.

- Safety transformer conforming to EN 61558-2-6
- Safe isolation between power supply and output circuits

Signals:

Frequency range: 0.001 Hz to 100 kHz
 Signal forms: Sine, square, triangular
 Offset: 0 to ±5 V, adjustable in 0.1 V steps

Output:

Output amplitude: 0 to 10 V, continuously adjustable
 Power output: 10 W, permanent
 Output current: 1 A, permanent, 2 A max.

Sweep:

Sweep modes: External, continuous internal, individual internal
 Frequency range: 1 Hz to 100 kHz
 Stop/start frequency ratio: Max. 1000:1, e.g. 2 Hz to 2 kHz max.
 Time range: 0.04 s to 1000 s
 External sweep: Start via trigger pulse or application of 0 to 5 V control voltage

Max. modulation frequency: 200 Hz
 Internal sweep: Start and stop via Start/Stop button
 One trigger output per cycle plus proportional voltage

General data:

Power supply: Plug-in power supply, 12 V AC, 2 A
 Dimensions: approx. 170x105x40 mm³
 Additional features: Fold-out feet

FG 100 Function Generator (230 V, 50/60 Hz)
P-1009957

FG 100 Function Generator (115 V, 50/60 Hz)
P-1009956



Advantages:

- Ideal for introductory student experiments on AC
- Simple generator for oscillations and waves

Function Generator SG 10

Sine-wave generator, which is particularly easy to use, featuring a power amplifier for use in student experiments. Includes 12 V AC plug-in power supply. One red and one green LED indicate the positive and negative half-waves of the output voltage. Their brightness corresponds to the configured amplitude. The way the output signal changes over time can be traced by means of an analog voltmeter with zero-point in the centre or by means of an oscilloscope. The output is protected against short-circuits and against induced voltages as well as spark discharges.

- Safety transformer conforming to EN 61558-2-6
- Safe isolation between power supply and output circuits

Signal form: Sine-wave
 Frequency range: 0.01 – 10 Hz
 Output amplitude: 1 – 10 V_{pp}, continuously adjustable
 LED display: As of 2 V output voltage
 Output power: 1.5 W permanent
 Output current: 300 mA max.
 Distortion factor: <5%
 Connectors: 4-mm safety sockets
 Power supply: 12 V AC, 500 mA plug-in power supply
 Dimensions: approx. 100x75x35 mm³
 Weight: approx. 400 g including plug-in supply

Function Generator SG10 (230 V, 50/60 Hz)
P-1017337

Function Generator SG10 (115 V, 50/60 Hz)
P-1017338



Dual Channel Function Generator 40 mHz...20 MHz

Real two channel function generator designed with direct digital synthesis technology for the generation of stable, high-precision signals with low distortion. Including an integrated frequency meter up to 100 MHz and 7 W power amplifier.

- High signal precision: 16 different signal waveforms
 - Independent output for two channels
 - Frequency and amplitude sweep
 - Frequency, periods, virtual amplitude or peak-to-peak value selection
 - USB interface
 - Quartz oscillator, HF accuracy (up to 10^{-5}) and high resolution (40 mHz)
- Including mains power cable, USB interface cable, software for Windows 95/98/NT/2000/XP/VISTA/7/8/10, BNC cable, replacement fuse and instruction manual.

Channels:	2
Frequency range:	40 mHz ... 20 MHz
Output signal:	16 signals like sinusoidal, square-wave, triangular etc.
Harmonic distortion:	-40 dBc
Total distortion:	< 1 %
Square-wave signal:	< 35 ns rise/fall time
Pulse duty factor:	1 – 99 %
Frequency resolution:	40 mHz
Amplitude range:	0 – 20 V _{pp}
Amplitude offset:	± 10 V
Amplitude resolution:	2 mV _{pp}
Operating voltage:	100 – 240 V, 50/60 Hz
Dimensions:	approx. 254x103x325 mm ³
Weight:	approx. 3 kg

P-1020913



Function Generator 10 mHz...3 MHz

Verstatile function generator designed with direct digital synthesis technology can be used as a normal signal generator, pulse generator and a sweep generator. Includes integrated 10 W power amplifier.

- HF accuracy: up to factor 10^{-5}
- 10 μ Hz frequency resolution across the entire frequency band
- Direct, digital setting and limiting for the entire range
- Start and end sweep frequency can be set as desired
- Frequency or periods, virtual amplitude value or peak-to-peak can be selected
- Keypad operation: direct digital or continuous adjustment
- USB device



Sine Wave Generator

Sine wave generator with power output up to 16 W in a frequency range from 1 Hz to 100 kHz. The apparatus contains a preamplifier, which can be used in isolation (e.g. as a microphone amplifier) or with a power output stage connected downstream as a broadband

amplifier (0 up to 100 kHz).

Sine wave generator with power output:

Frequency range:	1 Hz – 100 kHz, in 5 decadic stages, scale with linear division
Frequency deviation:	< 5 %
Output voltage:	0 – 6 V, adjustable
Max. output current:	10 A, short circuit proof
Max. output power:	16 W constant, 30 W temporary
Input impedance:	100 k Ω

Preamplifier:

Gain factor:	1 – 300, continuously adjustable
Input:	AC coupled, with switchable microphone voltage
Max. output voltage:	10 V _{pp}
Max. output current:	15 mA, short circuit proof
Output impedance:	1 k Ω

Power amplifier:

Voltage gain:	8.5
Operating voltage:	12 V AC
Dimensions:	approx. 160x160x50 mm ³
Weight:	approx. 1.1 kg

P-1001038

Additionally required:

- P-1000866 Transformer 12 V, 25 VA (230 V, 50/60 Hz)** or
- P-1000865 Transformer 12 V, 25 VA (115 V, 50/60 Hz)**

Including mains power cable, USB interface cable, software for Windows 2000/XP/VISTA/7/8/10, BNC cable and instruction manual.

Frequency range:	10 mHz ... 3 MHz
Output signal:	16 signals such as sinusoidal, square-wave, triangular, etc.
Frequency resolution:	10 μ Hz
Harmonic distortion:	-40 dBc
Total distortion:	< 1 %
Square-wave signal:	< 50 ns rise/fall time
Pulse duty factor:	1 – 99 %
Amplitude range:	0 – 20 V _{pp}
Amplitude offset:	± 10 V
Amplitude resolution:	5 mV _{pp}
Modulation:	FM, AM, PM, PWM, FSK
Operating voltage:	100 – 240 V, 50/60 Hz
Dimensions:	approx. 255x100x310 mm ³
Weight:	approx. 2 kg

P-1020912

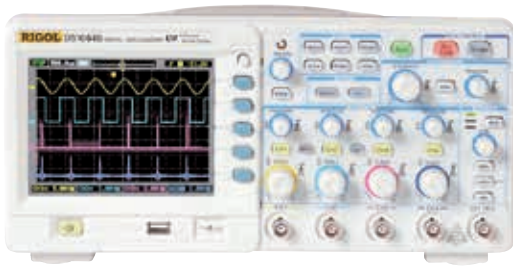

Digital Oscilloscope 4x70 MHz

Capable of simultaneously displaying four independent channels in colour, this digital oscilloscope offers the following functions: Storage and recall of measured signals, automatic measurement of up to 22 parameters, mathematical operations including fast Fourier transformation, delayed sampling, digital filtering. Including four probes, software and USB cable.

Inputs:

Coupling:	DC, AC, GND
Impedance:	1 MΩ ± 2%
Capacitance:	18 pF ± 3 pF
Probe attenuation factors:	0.001x – 1000x
Maximum input voltage:	100 V _{rms} , 1000 V _{pp} (in CAT II)
Mathematical operations:	FFT, +, -, *

Vertical deflection:

Deflection coefficient:	2 mV/div. – 10 V/div., 12 stages
Offset range:	2±40 V (245 mV/div. ~ 10 V/div.) ±2 V (2 mV/div. ~ 245 V/div.)
Accuracy:	±4 % (2 mV/div. – 5 mV/div.) ±3 % (10 mV/div. – 10 V/div.)
A/D converter:	8-bit resolution
Bandwidth	70 MHz
Rise time:	<5 ns

Horizontal deflection:

Time coefficient:	5 ns/div. – 50 s/div., 31 stages
-------------------	----------------------------------

Trigger:

Trigger sensitivity:	0.1 div. – 1.0 div., adjustable
Trigger threshold:	±6 div. (internal), ±1.2 V (EXT), ±6 V (EXT/5)
Trigger hold-off:	100 ns – 1.5 s
Operating mode:	Edge, pulse width, video, pattern and alternate trigger

Cursor measurements:

Manual:	Voltage difference, time difference, reciprocal time difference
Track:	Voltage values for Y-axis Time values for X-axis
Automatic:	On-line

Automatic measurement:

Measurement variables:	V _{pp} , V _{amp} , V _{max} , V _{min} , V _{top} , V _{base} , V _{avg} , V _{rms} , Overshoot, Preshoot, Freq, Period, Rise Time, Fall Time, +Width, -Width, +Duty, -Duty, Delay A→B+, Delay A→B-, Phase A→B+, Phase A→B-
------------------------	--

General data:

Display:	TFT-LCD, 5.7 inches, 320 pixels x 240 pixels, 64 k colours
Memory:	16 k
Interface configurations:	USB device, dual USB host
Supply voltage:	100 – 240 V, 50/60 Hz
Dimensions:	approx. 325x160x135 mm ³
Weight:	approx. 3 kg

P-1008676



Advantages:

- Greatest possible safety for users and computer systems thanks to galvanically isolated USB interface
- Mathematical functions +, -, *, /, inversion and FFT implemented
- 20 automatic measurement modes
- Powerful PC software for acquisition of data and for control

PC Oscilloscope, 2x25 MHz

Dual-channel PC oscilloscope for connection to a computer via USB ports. Includes isolated USB interface allowing a maximum input voltage of 400 V via the USB port.

By connecting the equipment to a PC, you obtain an extensively equipped digital storage oscilloscope with the additional advantage that the measurement data is saved and can, for example, be further analysed using fast Fourier transform (FFT) analysis.

Includes two probes (1:1, 10:1), a USB connecting cable, two BNC cables, operating instructions and software CD for Windows® XP/Vista/7/8

Channels:	Two
Band width:	25 MHz
Sample rate per channel:	100 MS/s
Operating modes:	CH1, CH2, XY

Input:

Input coupling:	DC, AC, GND
Input impedance:	1 MΩ ±2% 10 pF ±5 pF
Input voltage:	0 – 400 V DC or ACpp
Multi-input:	Sync., in/out, pass/fail, ext. trigger

Vertical:

Deflection coefficient:	2 mV/div. – 50 V/div.
Precision:	± 3%
A/D converter:	8-bit resolution

Horizontal:

Time-base coefficient:	5 ns/div. – 100 s/div.
Sampling range:	0.5 S/s – 200 MS/s
Precision:	100 ppm x reading + 0.6 ns

Measuring mode:

Automatic measurement:	V _{pp} , V _{max} , V _{min} , V _{top} , V _{base} , V _{amp} , V _{avg} , V _{rms} , overshoot, pre-shoot, rise time, fall time, +width, -width, +duty, -duty, delay A-B (rising), delay A-B (falling)
------------------------	--

Maths functions: +, -, *, /, inversion, FFT

Trigger:

Trigger type:	Alternate, Edge, Video, Pulse, Slope
Trigger modes:	Auto, Normal, Single
Trigger detection:	Sample, peak detect, average

Interfaces:

Memory size:	5000 measurements
Interface:	USB 2.0
Power supply:	5 V DC via two USB ports

Software:

Windows®:	XP/Vista/7/8
Data export for further assessment:	Formats: bin, txt, csv or xls
Image file for current screen:	Formats: png, bmp or gif

General data:

Dimensions:	approx. 170x120x18 mm ³
Weight:	approx. 260 g

P-1020857

Digital Oscilloscopes

Latest generation, dual-channel digital storage oscilloscope for many applications with the following features:

- High-resolution colour display and back-lighting
- Large internal data memory
- VGA output for connecting external monitor
- LAN connection for remote access via network
- USB port for real-time data transmission or for reading internal memory
- Autoset and autoscale functions for user-friendly operation
- 20 automatic measuring modes plus FFT function
- PASS/FAIL function

Includes two probes, two BNC cables, USB connecting cable, and software CD for Windows 2000/XP/VISTA/7/8/10.

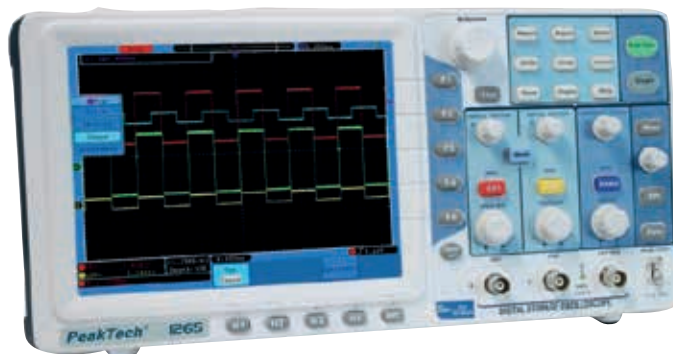

Digital Oscilloscope 2x30 MHz P-1020910

Digital Oscilloscope 2x100 MHz P-1020911

Art. No.	P-1020910	P-1020911
Channels:	Two	
Band width:	30 MHz	100 MHz
Sample rate:	Dual CH 125 MS/s Single CH 250 MS/s	Dual CH 500 MS/s Single CH 1 GS/s
Operating modes:	CH1, CH2, XY	
Input:		
Input coupling:	DC, AC, GND	
Input impedance:	1 MΩ ±2% 10 pF ± 5 pF	
Input voltage:	0 – 400 V DC or AC _{pp}	
Vertical:		
Deflection coefficient:	5 mV/div. – 5 V/div.	2 mV/div. – 10 V/div.
Precision:	± 3 %	
A/D converter:	8 Bit resolution	
Horizontal:		
Time-base coefficient:	4 ns/div. – 100 s/div.	2 ns/div. – 100 s/div.
Sampling range:	5 S/s – 125 MS/s	0,5 S/s – 250 MS/s
Precision:	100 ppm x reading + 0,6 ns	100 ppm
Measuring mode:		
Automatic measurement:	V _{pp} , V _{max} , V _{min} , V _{top} , V _{base} , V _{amp} , V _{avg} , V _{rms} , Overshoot, Preshoot, Rise Time, Fall Time, +Width, - Width, +Duty, -Duty, Delay A-B (rising), Delay A-B (falling), Freq, Period	
Maths functions:	+, -, *, /, FFT	
Trigger:		
Trigger type:	Edge, Video, Pulse, Slope	
Trigger modes:	Auto, Normal, Single	
Trigger detection:	Sample, Peak Detect, Average	
Interfaces:		
Memory size:	10000 measurements	
Interface:	USB 2.0, VGA, LAN	
Power supply:	100 – 240 V, 50/60 Hz	
General data:		
Display:	TFT- Color display, 8 inch, 800 x 600 Pixel, 65536 Colors	
Dimensions:	approx. 355x178x118 mm ³	approx. 340x155x70 mm ³
Weight:	approx. 1,6 kg	approx. 1,8 kg

Analogue Oscilloscope, 2x20 MHz (230 V, 50/60 Hz)

Robust, easy-to-operate dual channel oscilloscope with a bandwidth of 20 MHz. Includes 2 adaptors and 2 BNC/4-mm safety plug connector cables. For technical data see 3bscientific.com.

P-1008695



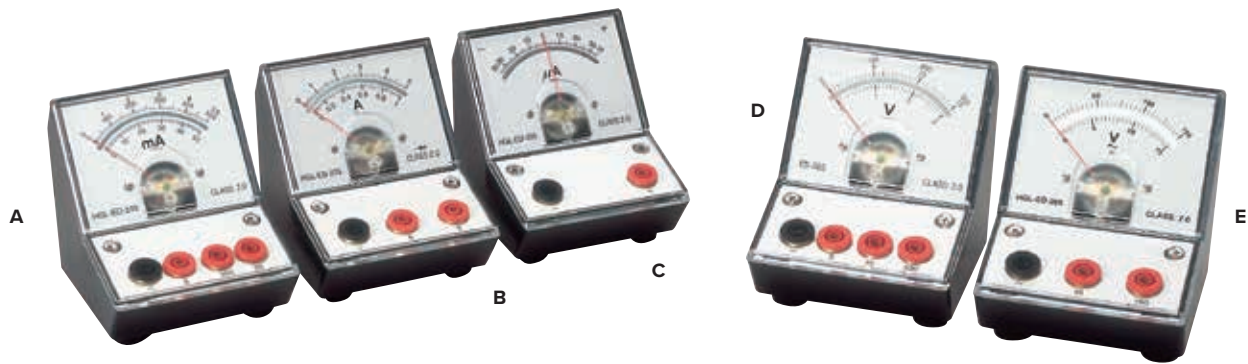

Measuring Instruments for Student Use

Sturdy pointer instruments for measuring current or voltage. In shock-proof desktop-housings. Built especially for student and practical lab experiments. With moving coil instruments, mirror scale and 4 mm safety sockets.

Accuracy: class 2.0
 Dimensions: approx. 90x106x103 mm³

Art. No.	Designation	Meas. ranges	Scale division	Internal resistance
A. P-1002786	Ammeter, DC	50 mA, 500 mA, 5.0 A	1 mA, 10 mA, 0.1 A	10 Ω
B. P-1002788	Ammeter, AC	1.00 A, 5.0 A	0.02 A, 0.1 A	Rectifier
C. P-1002790	Galvanometer, DC	±35 μA	1 μA	1000 Ω
D. P-1002787	Voltmeter, DC	3.0 V, 15 V, 300 V	0.1 V, 1 V, 10 V	1 KΩ/V
E. P-1002789	Voltmeter, AC	15.0 V, 150 V	0.5 V, 5 V	Rectifier



Demo Multimeter

Electronic meter featuring a double scale for analogue measurement of current and voltage in demonstration experiments. It can handle measurements of current and voltage values and also allows the zero point to be set up in the centre of the scale for measurement of DC quantities. Switching between measuring ranges does not break any circuits connected to the

equipment. This means it is possible to carry out measurements on voltage converters, for example, without causing induction surges. Resistance R , conductance G , impedance Z and admittance Y can easily be determined as quotients of current and voltage measurements thanks to the non-interrupting switch capability without the need to change the wiring.

This equipment is protected by fuses and authorised for making measurements in circuits directly connected to the low-voltage mains via plugs (CAT II), i.e. for measurements on house-hold appliances, for example. The current measuring ranges are resistant to long-term overloading up to 10 A. The meter is suitable for use as a free-standing instrument or for setting up in training panel frames.

Voltage ranges: 0.1 - 600 V AC/DC, 9 ranges
 Current ranges: 0.1 mA - 10 A AC/DC, 11 ranges
 Overload protection: 600 V long-term in all voltage ranges
 10 A of long-term loading in 3-A and 10-A ranges
 Measuring category: CAT II: 600 V
 Connectors: 4-mm safety sockets
 Fuses: 2x FF 10 A/600 V (10 x 38 mm)
 Power supply: 1x 1.5 V battery, AA IEC LR6
 Automatic cut-off after: 45 min ± 10 min
 Scale length: 160 mm
 Height: 297 mm
 Dimensions: approx. 259x297x125 mm³
 Weight: approx. 1.7 kg

P-1017895



Zero Point Galvanometer CA 403

Reasonably priced, sturdy and easy to use analogue measuring instrument with moving coil instrument and rectifier, particularly well suited for student and practical experiments, may be used as a DC microammeter and DC millivoltmeter. This device has only one control knob, includes safety sockets and quick break fuses, is electrically protected and double insulated.

Measuring ranges: 100 mV DC, 30 μA DC, 3 mA DC
 Internal resistance: 3333 Ω, 460 Ω, 500 Ω
 Accuracy: ±1.5%
 Zero point: centre
 Mirrored scale: yes
 Connection: 4 mm security sockets
 Fuse: 0.315 A HBC 380 V

Dimensions: approx. 165x105x50 mm³
 Weight: approx. 450 g

P-1002726



Advantages:

- **Unmistakeable measurement readings**
- **Only an inexpensive 1.5-V battery element is needed for operation**
- **Full functionality guaranteed even when the battery is no longer fully charged**
- **Lithium batteries with higher open-circuit voltage can also be used**
- **Battery protected by automatic cut-off after approximately 50 mins.**
- **Distinct difference between 0 V display and the equipment being switched off due to inherently different position of needle**



No need to change fuses

The ideal meter for student experiments:

Analogue Multimeters ESCOLA

Clear moving-coil instrument in shock-resistant plastic casing with two mirrored linear scales and clearly distinguishable measuring ranges. Includes battery test function and display of charge status as well as electronic calibration of zero point to the centre of the scale for all DC current and voltage ranges. Use of a measurement amplifier ensures the measured values are linear even for AC voltages of up to 40 kHz. Only an inexpensive 1.5 V battery element is needed for operation. Nevertheless the meter will work for several years after any change of battery with normal usage, since the current discharge when in operation is no more than 2.5 mA maximum.

Scale length:	80 mm
Operating voltage:	1 – 3.5 V DC
Battery type:	Mignon, AA, R6
Accuracy:	Class 2 (DC), class 3 (AC)
Dimensions:	approx. 100x150x50 mm ³
Weight:	approx. 300 g

Note:

Electrical safety of measuring instruments for current and voltage are assessed according to measurement categories stipulated in IEC 61010-1:

- CAT I or unstipulated: Approved for measurements in circuits which are not directly connected to the low voltage mains grid (e.g. batteries).
- CAT II: Approved for measurements in circuits which are directly connected, by a mains lead and plug for instance, to the low voltage mains grid (e.g. household or office appliance and lab equipment).
- CAT III: Approved for measurements in circuits which are part of a building's wiring installation (e.g. stationary consumers, distribution terminals, appliances connected directly to the distribution box).
- CAT IV: Approved for measurements in circuits which are directly connected to the source of the low voltage mains (e.g. electricity meters, main service feed, primary excess voltage protection).
- N.B.: the closer measurement is to be made to the low-voltage mains installation, the higher the measuring category needs to be.

Analogue Multimeter ESCOLA 30

Permanently short-circuit-proof student measuring instrument for measuring voltage and current in the safety extra-low voltage range.

The electronic overload protection is achieved without the use of an equipment fuse, therefore obviating any need to change fuses or order spares. The protective system nevertheless operates without any auxiliary energy and is guaranteed even when the battery is flat or no battery is present.

Direct and alternating voltage:	0.3 – 30 V, 5 ranges each
Direct and alternating current:	1 – 3000 mA, 5 ranges each
Instrument category:	CAT I, 30 V

P-1013526

CAT III, 600 V



Analogue Multimeter ESCOLA 100

Meter for classroom and practical experiments to measure voltage and current up to 600 V or 10 A respectively. Also features audible continuity testing. Includes a fuse to guarantee safety up to CAT III.

The separate terminal sockets for current and voltage permit connection of the instrument that allows for current as well as voltage to be measured without having to reconnect the measuring leads. When switching from one measuring range to another, the circuit is never broken. All current measuring ranges are overload-proof for long-term current of up to 10 A. The generous protection of all current measuring ranges by means of additional semiconductor protection prevents inadvertent blowing of the fuse in many cases.

Direct and alternating voltage:	0.1 – 600 V, 9 ranges each
Direct and alternating current:	0.1 mA – 3000 mA, 11 ranges each
Internal resistance:	1 MΩ
Long term maximum voltage:	600 V
Instrument category:	CAT III, 600 V (DIN EN 61010-1:2010, 61010-2-033:2012)

P-1013527



Digital Mini Multimeter

Very reasonably priced mini multimeter in pocket format for measuring voltage, DC current, resistance and temperature and also including diode and continuity tests. Overload protection for mA ranges, 10 amp range is unprotected. Includes measuring leads, type K thermocouple and battery.

DC voltage:	200 mV–250 V, 5 ranges, ±0.8% ±2 digits
AC voltage:	200/ 250 V, 2 ranges, ±1.2% ±10 digits
DC current:	200 µA–10 A, 5 ranges, ±1.0% ±2 digits
Resistance:	200 Ω–2000 kΩ, 5 ranges, ±0.8% ±2 digits
Temperature:	0–1000°C, ±2.0% ±3 digits
Display:	3½ digit LCD, 12 mm, max: 1999
Operating voltage:	9 V battery
Safety classification:	CAT II 250 V (IEC-1010-1)
Fuse:	F1: F 250 mA / 300 V F2: F 10 A / 300 V, $I_{max} = 10$ A for 10 s with minimum interval 15 mins
Dimensions:	approx. 70x140x30 mm ³
Weight:	approx. 210 g

P-1002783



Advantages:

- Ideal for student experiments
- Easy to replace fuses

Digital Multimeter P1035

Compact 3½ digit multimeter for measuring voltage, current and resistance and also including diode and continuity tests. Complete with pouch, leads and battery.

DC voltage:	200 mV–600 V, 5 ranges, ±0.5% ±2 digits
AC voltage:	200/ 600 V, 2 ranges, ±1.2% ±10 digits
DC current:	2000 µA–10 A, 4 ranges, ±1% ±2 digits
Resistance:	200 Ω–2000 kΩ, 5 ranges, ±0.8% ±2 digits
Display:	3½ digit LCD, 27 mm, max: 1999
Operating voltage:	9 V battery
Safety classification:	CAT III 600 V (IEC-1010-1)
Fuse:	F1: F 200 mA / 600 V F2: F 10 A / 600 V, $I_{max} = 10$ A for 30 s with minimum interval 15 mins
Dimensions:	approx. 70x150x48 mm ³
Weight:	approx. 260 g

P-1002781

Digital Multimeter P3340

Digital multimeter for universal use in measuring voltage, current, resistance, frequency, capacitance, temperature and also including diode and continuity tests. Includes a measurement value hold function, analogue bar graphs, automatic polarity reversing, overload and overvoltage protection as well as an acoustic overload indicator, automatic switch off. Device comes in a shock-proof holster with fold-out stand. Including testing leads, type K temperature sensor and batteries.

DC voltage:	400 mV–1000 V, 5 ranges, ±0.5% ±2 digits
AC voltage:	4–700 V, 4 ranges, ±1.2% ±3 digits
DC current:	400 µA–10 A, 6 ranges, ±1% ±3 digits
AC current:	400 µA–10 A, 6 ranges, ±1.5% ±5 digits
Resistance:	400 Ω–40 MΩ, 6 ranges, ±1% ±2 digits
Capacity:	40 nF–100 µF, 5 ranges, ±3% ±5 digits
Temperature:	-20–760°C, ±3% ±3 digits
Display:	3¾ digit LCD, 39 mm, max: 3999
Operating voltage:	9 V battery
Safety classification:	CAT II 1000 V (IEC-1010-1)
Fuse:	F1: F 500 mA / 600 V F2: F 10 A / 600 V, $I_{max} = 10$ A for 30 s
Dimensions:	approx. 92x195x38 mm ³
Weight:	approx. 200 g

P-1002785

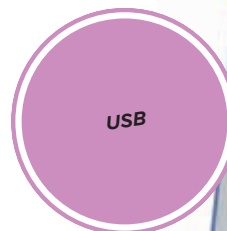

Digital Multimeter P3320

Digital multimeter for universal use in measuring voltage, current, resistance, frequency, capacitance and temperature. With real time rms measurement feature and backlighting. 3⁵/₆ digit LCD display with function symbols and analogue bar graphics. Automatic and manual range selection. With non-contact voltage detector. Includes measuring leads, type K thermocouple, shock resistant pouch and battery.

DC voltage:	600 mV–1000 V, 5 ranges, ±1.2% ±2 digits
AC voltage:	6 V–1000 V, 4 ranges, ±1.5% ±10 digits
DC current:	6 A–10 A, 2 ranges, ±2.5% ±5 digits
AC current:	6 A–10 A, 2 ranges, ±3% ±5 digits
Resistance:	600 Ω–60 MΩ, 6 ranges, ±1% ±2 digits
Capacity:	40 nF–4000 μF, 6 ranges, ±5% ±5 digits
Frequency:	10 Hz–10 MHz, 7 ranges, ±1.2% ±3 digits
Temperature:	-20–760°C, ±3%
Display:	3 ⁵ / ₆ digit LCD, 19 mm, max: 3999
Operating voltage:	9 V battery
Safety classification:	CAT III 600 V / CAT II 1000 V (IEC-1010-1)
Fuse:	F 10 A / 600 V, I_{max} = 10 A for 30 s
Dimensions:	approx. 70x150x48 mm ³
Weight:	approx. 260 g

P-1002784

Digital Multimeter E

Compact 3½-digit multimeter for measuring voltage, current and resistance as well as for diode and hFE gain testing. All measurement ranges are selected by means of a rotary dial. All measurement ranges are protected against overload. Includes measuring leads and battery.

DC voltage:	2 V – 600 V, 4 ranges, ±0.8% ±5 digits
AC voltage:	2 V – 600 V, 4 ranges, ±1% ±5 digits
DC current:	20 μA – 10 A, 7 ranges, ±1.8% ±2 digits
AC current:	20 μA – 10 A, 7 ranges, ±2% ±3 digits
Resistance:	200 Ω – 200 MΩ, 7 ranges, ±1% ±4 digits
digits Display:	3½ display LCD, 24 mm, max. 1999
Operating voltage:	9 V battery 6F22
Fuse:	F1: F 2 A / 600 V F2: F 10 A / 600 V, I_{max} = 10 A for 10 s with minimum interval 15 mins
Dimensions:	approx. 90x190x35 mm ³
Weight:	approx. 310 g

P-1018832

Digital Multimeter P3415

This innovative digital multimeter uses an opto-coupled USB cable to connect directly to a computer to allow you to record up to three measurements per second. A wide range of functionalities such as autoranging, relative measurements, and Min/Max/Hold also make this a highly versatile stand-alone tool. Measuring modes include DCV, ACV, DCA, ACA, resistance, diode, continuity, frequency, capacitance and temperature. The unit is supplied with a carrying case, USB cable, Software for Windows 2000/XP/Vista/7, type-K thermocouple, test leads, test clips, battery and operation manual.

DC voltage:	600 mV–1000 V, 5 ranges
AC voltage:	600 mV–700 V, 5 ranges
DC current:	600 μA–10 A, 6 ranges
AC current:	600 μA–10 A, 6 ranges
Resistance:	600 Ω– 60 MΩ, 6 ranges
Frequency:	100 Hz–1 MHz, 5 ranges
Capacity:	60 nF–300 μF, 5 ranges
Temperature:	-55 °C–1000 °C, 2 ranges
Display:	3 ⁵ / ₆ digit LCD, 18 mm
Operating voltage:	9 V battery
Safety classification:	CAT III 1000 V / CAT IV 600 V (IEC-1010-1)
Fuse:	F1: F 0.63 A / 1000 V F2: F 10 A / 1000 V, I_{max} = 10 A for 4 mins with minimum interval 14 mins
Dimensions:	approx. 90x190x40 mm ³
Weight:	approx. 500 g

P-1008631



DMM Digital Multimeter

Digital multimeter for conducting measurements in situations where a high degree of safety needs to be assured. Automatic blocking of sockets (ABS), which are not used for specific functions. Back-lit liquid crystal display with digital read-out and analogue bar chart scale. Economy mode with automatic shut-off after 10 minutes without the measured reading changing. Excess voltage and overload warning, automatic or manual range selection, data storage and maximum and minimum functions. Supplied with measurement leads, 9-V block battery, spare fuse, English instructions, test report and impact-resistant protective case with stand legs and carrying strap.

Measured variables and ranges:

DC voltage:	30.00 mV (10 μ V) – 1000 V (1 V), 6 ranges $\pm 0.25\%$ ± 1 digit
AC voltage:	3.000 V (1 mV) – 1000 V (1 V), 4 ranges $\pm 0.75\%$ ± 1 digit
Direct current:	300.0 μ A (100 nA) – 10.00 A (10 mA), 6 ranges $\pm 1.00\%$ ± 2 digits
Alternating current:	3.000 mA (1 μ A) – 10.00 A (10 mA), 4 ranges $\pm 1.50\%$ ± 2 digits
Resistance:	30.00 Ω (10 m Ω) – 30.00 M Ω (10 k Ω), 7 ranges
Capacitance:	30.00 nF (10 pF) – 30.00 μ F (10 nF), 4 ranges
Frequency:	300.0 Hz (0.1 Hz) – 100.0 kHz (100 Hz), 4 ranges

Other variables:

Duty cycle:	2.0% – 98.0%
Temperature*:	-200.0°C – +850.0°C (Pt 100) -100.0°C – +850.0°C (Pt 1000)
Continuity test:	Yes
Diode test:	2 V

Other data:

Safety category:	CAT III 1000 V (IEC 61010-1:2001) CAT IV 600 V (IEC 61010-1:2001)
Dimensions:	approx. 200x80x30 mm ³
Weight:	approx. 700 g

DMM50 Digital Multimeter

Digital multimeter without true RMS (TRMS) measurement capability.

P-1012817

DMM60 Digital Multimeter

Digital multimeter with true RMS (TRMS) measurement capability for distorted input signals.

P-1012816

DMM 1000 Iso-Multimeter

Digital multimeter with integrated insulation resistance measuring capability for voltages from 50 V to 1000 V and additional measuring functions for testing AC and DC voltage and current, resistance, capacitance, frequency and temperature plus diode testing. Automatic blocking of sockets (ABS), which are not used for specific functions. Automatic shut-off, excess voltage and overload warning, true RMS (TRMS) measurement capability for distorted input signals. Back-lit liquid crystal display with digital read-out and analogue bar chart scale. Supplied with English instructions and impact-resistant protective case with stand legs.

Safety category:	CAT II 1000V CAT III 600 V
------------------	-------------------------------

P-1012865



Digital Energy Meter

Digital meter for measuring consumption of electrical energy by appliances connected to the mains and for determining bills given a rate for kilowatts per hour. Thanks to the extremely high resolution and the low operating response even very small or standby consumers can be measured starting at approx. 1 W. Supplied with an internal battery for memory back-up.

Values displayed:	Energy, costs incurred, power, voltage, current, time, day of the week
Input voltage:	230 V, 50/60 Hz
Maximum permitted load:	3680 W/16 A
Minimum load for display:	1 W/0.005 A
Energy:	0 – 9999.9 kWh
Current:	0.005 – 16 A
Active power:	0 – 3680 W
Accuracy:	±0.5%
Safety classification:	Cat II 300 V (IEC-1010-1)
Operating voltage:	internal battery for memory back-up
Dimensions:	approx. 120x60x75 mm ³
Weight:	approx. 160 g

P-1002802

Sound Level Meter P5055

Digital measuring instrument for universal application in detecting noise levels from a variety of sound sources over a broad range. Features built-in calibration signal plus maximum value and value hold functions. Slow mode for average noise level and fast mode for recording brief sound sequences and determining maximum noise level. A-weighting of frequency (based on human hearing) for open-air measurements and also C-weighting, e.g. for measurements of engine noise.

Robust plastic casing, analogue output for external measuring instruments, threaded hole for mounting on a stand. Foam-filled carry case.

Measurement range:	35 – 130 dB
Resolution:	0.1 dB
Accuracy:	±3.5 dB at 94 dB (1kHz)
Display:	3½-digit LCD display
Digit height:	17 mm
Microphone:	Electret capacitor microphone
Power supply:	9 V block-type battery
Dimensions:	approx. 251x64x40 mm ³
Weight:	approx. 250 g

P-1002778

Noise Level Meter P8005

Digital noise meter with background noise suppression for all types of measurements of ambient noise, e.g. for measuring noise levels in schools, offices, factories, traffic and homes or for noise projects. Includes data logger and USB port for long-term measurements. Choice of manual and automatic operating modes. Capability for min. and max. measurements. Includes case, USB cable, Windows software, stand, 9 V mains adaptor, 9 V battery and instruction manual.

Frequency range:	31.5 Hz – 8 kHz
Dynamic range:	50 dB
Level ranges:	30 – 80 dB (low) 50 – 100 dB (medium) 80 – 130 dB (high) 30 – 130 dB (automatic)
Precision:	±1.4 dB
Digital display:	4 digit LCD, 20 mm
Multi-functions display:	Digital display of measurement, measuring time, bar graphs plus overs and unders
Applicable standards:	IEC-61672-1 type 2, ANSI S1.4 type 2
Response times:	125 ms (fast), 1s (slow)
Microphone:	½-inch, with electret capacitor
Display update:	Twice a second
Analogue output:	AC/DC
Operating voltage:	9 V battery or 9 V mains adaptor
Dimensions:	approx. 90x280x50 mm ³
Weight:	approx. 350 g

P-1002780

Digital Luxmeter

Reasonably priced, easy to use pocket luxmeter for testing and measurement of light conditions. C.I.E. standard spectrum. Including light sensor, pouch and battery.

Measuring ranges:	200 – 50000 lux, 4 ranges, ±5%
Operating voltage:	12 V battery (A23)
Dimensions:	approx. 65x115x25 mm ³
Weight:	approx. 160 g

P-1002779



Digital Counter

Digital counter/timer for measuring duration of motion, transition times, periods, pendulum periods and frequencies, as well as for counting events or Geiger tube pulses. Includes a speaker that can be turned on and off, power supplies for direct connection to light barriers (P-1000563) or for powering a Geiger-Müller counter (P-1001035). For event counting, a fixed counting period can be programmed in a range from 1 s to 99999 s. Counter events (start, stop) can either be triggered by a signal to the input sockets or manually via switches. Includes plug in power supply.

Time measurement: 0.1 ms – 99999 s
 Resolution: 0.1 ms / 1 ms / 0.1 s
 Frequency measurement: 1 – 100 kHz, where voltage > 1.5 V_{pp}
 Resolution: 1 mHz (1 – 100 Hz), 1 Hz (1 – 100 kHz)

Counting periods: 1/10/60 s or manually triggered
 Input A: miniDIN 8 socket, 4 mm safety sockets
 Input B: miniDIN 8 socket, 4 mm safety sockets
 Input voltage A: 0.5 V – 15 V AC
 Input voltage B: 1 V – 15 V AC
 Active edge: Rising/falling
 Counter tube input: BNC socket
 Power supply: 550 V / 1 MΩ
 Display: 5 digit LED display
 Operating voltage: 12 V AC, 300 mA via via plug in power supply
 Dimensions: approx. 250x100x160 mm³
 Weight: approx. 0.8 kg

Digital Counter (230 V, 50/60 Hz)
P-1001033

Digital Counter (115 V, 50/60 Hz)
P-1001032

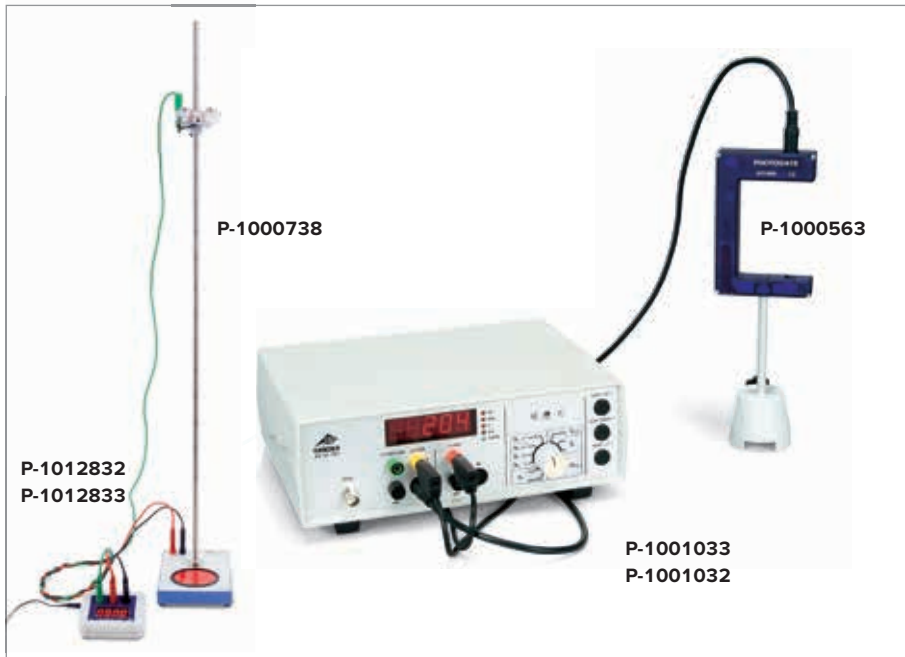

Millisecond Counter

Inexpensive, compact counter for measuring milliseconds, e.g. in conjunction with the free-fall apparatus (P-1000738). Each count is started and stopped by a signal at the input sockets. The device is automatically reset to zero each time it is restarted. Includes plug-in power supply.

Time measurement: 1 ms – 9999 s
 Supply voltage: 12 V AC
 Connectors: 4-mm safety sockets
 Dimensions: approx. 105x75x35 mm
 Weight: approx. 400 g

Millisecond Counter (230 V, 50/60 Hz)
P-1012832

Millisecond Counter (115 V, 50/60 Hz)
P-1012833

Laser Reflection Sensor

Sensor for triggering the VinciLab unit (P-1021477) or the digital counter (P-1001033/P-1001032) in time measurements on moving objects. Suitable for opto electronic scanning of light and dark markings on moving objects or in conjunction with a reflecting foil to form a wide spaced obstruction sensor. The intensity of the laser beam is adjusted automatically according to the distance of the object. Includes reflecting foil, stand rod with screw thread and connector lead with 8 pin miniDIN plugs.

Maximum range: 2.5 m
 Laser power: <1 mW
 Laser protection class: II

P-1001034



Additionally required for attaching to VinciLab unit:

P-1021688 Connection Cable MiniDIN8 – BT



Measurement Amplifier U

Measurement amplifier U amplifies low-amplitude measurement signals from low-resistance signal sources for measurement with any chosen voltmeter or oscilloscope. By using an external shunt resistor it is also possible to measure small currents. Offset voltages can be compensated using coarse and fine offset adjustment knobs. Amplification (gain) can be selected in ranges from 0 to 5 powers of ten. High-frequency noise or other interference signals are filtered out by means of a low-pass filter with step-wise selectable time constants between 0 and 3 seconds. The output voltage has the same sign as the input voltage.

Input resistance:	10 k Ω
Output resistance:	300 Ω
Offset voltage drift:	< 2 μ V/K (after 15 mins.operation approx.)
Gain factors:	10 ⁰ ; 10 ¹ ; 10 ² ; 10 ³ ; 10 ⁴ ; 10 ⁵
Tolerance for gain factors:	< 2.5 %
Input voltage:	max. \pm 12 V (overload protected for brief transients up to 100 V)
Output voltage:	0 ... \pm 12 V (short-circuit protected)
Power supply (via plug-in supply provided):	12 V AC
Ambient temperature:	5°C ... 23°C ... 40°C
Storage temperature:	-20 ... 70°C
Relative humidity:	<85% no condensation
Operational alignment:	Horizontal
Contamination level:	2
Protection class:	IP20
Dimensions:	approx. 170x105x50 mm ³
Weight:	approx. 335 g

Measurement Amplifier U (230 V, 50/60 Hz)
P-1020742

Measurement Amplifier U (115 V, 50/60 Hz)
P-1020744



Measuring Amplifier S

Measuring amplifier for measuring small voltages and current in conjunction with an ordinary voltmeter in the course of student experiments.

Measuring range with reference to 1 V output voltage:

Voltage (AC/DC):	1 mV – 1 V
Current (AC/DC):	100 nA – 100 μ A
Frequency range:	0 – 20 kHz ($v = 1$) 0 – 500 Hz ($v = 1000$)

Input impedance:	10 k Ω
Input U:	BNC socket
Input I:	BNC socket
Max input voltage:	10 V
Output:	4 mm safety sockets
Max output voltage:	10 V
Limiting frequency:	100 Hz
Gain factor:	106
Accuracy:	2 %
Operating voltage:	12 V AC
Dimensions:	approx. 175x85x65 mm ³
Weight:	approx. 250g

P-1001028

Additionally required:

P-1000866 Transformer 12 V, 25 VA (230 V, 50/60 Hz)

or

P-1000865 Transformer 12 V, 25 VA (115 V, 50/60 Hz)

P-1013527 Analogue Multimeter ESCOLA 100



Digital Stroboscope (230 V, 50/60 Hz)

Portable microprocessor-controlled device with quartz-controlled time base for observation of periodic movements, as well as for frequency and rotation speed measurement. Xenon flash tube built into a robust plastic casing with handle and photo thread for mounting on a stand, continuous frequency adjustment in two ranges through coarse and fine setting using control knobs, 4-digit digital display permits readings of the desired flash sequence per minute.

Meas. ranges:	100 min ⁻¹ – 1000 min ⁻¹ (approx. 1.5 Hz – 18 Hz) 1000 min ⁻¹ – 10000 min ⁻¹ (approx. 18 Hz – 165 Hz)
Accuracy:	\pm (0.05% + 1 digit)
Display:	4-digit LED
Resolution:	0.1 min ⁻¹ (< 1000 min ⁻¹) 1 min ⁻¹ (1000 min ⁻¹ – 9999 min ⁻¹) 10 min ⁻¹ (10000 min ⁻¹)
Flash duration:	60 μ s – 100 μ s
Flash energy:	4 Ws
Flash angle:	80°
Dimensions:	approx. 210x210x120 mm ³
Weight:	approx. 1 kg

P-1003331

Spare Bulb, Stroboscope (not shown)

Spare bulb for the Digital Stroboscope (P-1003331).

P-1003332

Teslameter N

This economical digital teslameter will allow students to incorporate quantitative measurements into their magnetism experiments. The unit includes a Hall sensor probe for measuring axial and tangential magnetic fields up to 200 mT. The probe also serves as a ruler as it includes a metric scale. There are two measuring ranges, 0 – ±20 mT and 0 – ±200 mT. The teslameter can be calibrated by the user. In addition to having a digital display, the unit outputs a voltage proportional to the magnetic field which can be measured with a data logger, XY-recorder or analogue multimeter.

Measurement ranges: 0 – ±20 mT, 0 – ±200 mT

Resolution: 0.01 mT, 0.1 mT

Digital Display: 3½ digit LCD

Height of digits: 13 mm

Input: GX16-6 socket

Output: 4 mm safety sockets

Dimensions of unit: approx. 205x230x85 mm³

Dimensions of probe: approx. 360x15x25 mm³

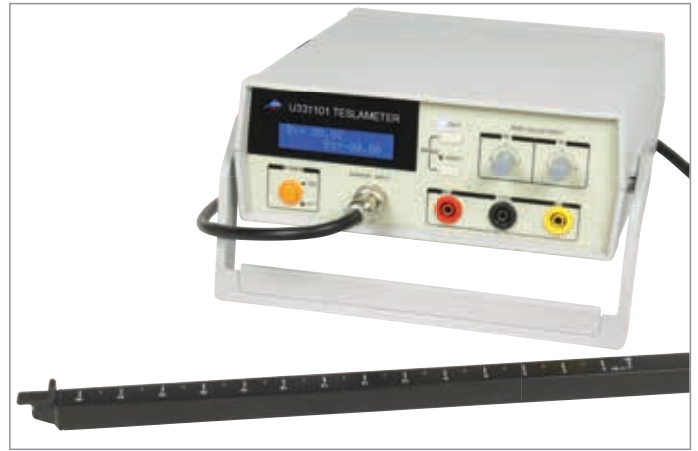

Teslameter N
(230 V, 50/60 Hz)
P-1021669

Teslameter N
(115 V, 50/60 Hz)
P-1021671

Teslameter E

Hand-held meter for measuring magnetic flux density B or magnetic field strength H in conjunction with an axial-tangential field sensor (P-1001040) or a flexible magnetic field sensor (P-1012892). The measurements are shown on a digital display and also converted into equivalent voltage outputs, which can be accessed from the analogue output connection.

LCD display: 3½-digit, 10 mm high

Power supply: Rechargeable 9-V block battery providing about 20 hours of operation

Sensor connection: DIN socket

Offset compensation: ±0.150 mT

Measuring modes:

DC-B Flux B of uniform fields

AC-B Flux B of alternating fields (1 Hz – 10 kHz)

AC-H Field strength H of alternating fields (1 Hz – 10 kHz)

Measuring ranges:

Flux B: ±2.000/±20.00/±200.0/±2000 mT

Field strength H: ±2.000/±20.00/±200.0/±2000 A/m

Analogue output:

Connector: 4-mm socket

Range: 0 – ±2 V

P-1008537

Additionally required:

P-1001040 Magnetic Field Sensor, Axial/Tangential

or

P-1012892 Flexible Magnetic Field Sensor



Flexible Magnetic Field Sensor

Flexible magnetic field sensor with built-in Hall sensor for measuring tangential magnetic fields in connection with the E-model teslameter (P-1008537).

Sensitivity: 1 mV/mT

Length of probe (without handle): 75 mm

Thickness of probe: 0.6 mm

Hall sensor: Monocrystalline InAs

Sensor surface: 1 mm²

Connection: DIN plug

P-1012892

Magnetic Field Sensor, Axial/Tangential

Magnetic field sensor with two built in Hall sensor probes for measuring axial and tangential magnetic fields in conjunction with the teslameter (P-1008537). A slider switch provides for switching between axial and tangential measuring modes.

Sensitivity: 1 mV/mT

Length of probe (without handle): approx. 125 mm

Thickness of probe: 4 mm

Hall sensors: Monocrystalline InAs

Sensor surface: 1 mm²

Connection: DIN plug

P-1001040



A

A. Magnetic Stirrer with Heater

Magnetic stirrer with stainless steel hotplate and secure safety circuit. Variable heating temperature and smooth starting stirrer motor. Housing resistant to chemicals.

Quantity stirred, max. (H₂O): 10 l
 Speed: 100 – 2000 rpm
 Heater power: 400 W
 Heating temperature range: Room temperature to 320° C
 Work plate: 125 mm diam.
 Dimensions: approx. 168x105x220 mm³
 Weight: approx. 2.4 kg

Magnetic Stirrer with Heater (230 V, 50/60 Hz)

P-1002807

Magnetic Stirrer with Heater (115 V, 50/60 Hz)

P-1002806

B. Magnetic Stirrer 12L (230 V, 50/60 Hz)

Electronically regulated magnetic stirrer in stainless steel casing with an aluminium hot plate. Accommodates stand rods (12 mm diam.) and has a 12 V DC output to supply power to accessories. Includes stirring rods.

Maximum speed: 1500 rpm
 Hot plate: 135 mm diam.
 Maximum temperature: 450° C
 Power consumption: 400 W
 Dimensions: approx. 165x220x105 mm³
 Weight: approx. 2 kg

P-1011739



Magnetic Stirrer

Ultra flat magnetic stirrer with non wearing drive featuring no moving parts. With feature for changing direction of stirring automatically every 30 seconds for improved homogenisation. Work plate and housing resistant to chemicals, non slip and secure base. Including plug in power supply and stirring rods.

Quantity stirred, max. (H₂O): 0.8 l
 Speed: 15 – 1500 rpm
 Work plate: 100 mm diam.
 Power supply: power supply unit 100 V – 240 V, 50/60 Hz
 Dimensions: approx. 117x12x180 mm³
 Weight: approx. 0.3 kg

P-1002808



B



C

C. Electrical Burner LAB2 (230 V, 50 Hz)

Burners for experiments which would have formerly needed to be undertaken using a Bunsen burner. Designed to be both thermally and electrically safe. Heating via a column of hot air with a patented air management system. Featuring operation and temperature displays.

- Controlled via energy regulator with bimetallic strips
- Protected against overheating
- No overheating of housing during long periods of use
- Boils liquids without causing them to spit
- Perfectly sealed against spilt liquids

Liquid reservoir: Up to 140 mm in diameter
 Operating temperature: 20 ... 650° C
 Temperature of heating element: max. 900° C
 Electrical power consumption: 500 W
 Fuse: F-type, 5A, 250 V
 Dimensions: approx. 170x130x195 mm³
 Weight: approx. 3.8 kg

P-1010252

Immersion Heater, 300 W (230 V, 50/60 Hz)

Immersion heater with protection against overheating (VDE-compliant). Important: operates solely on a mains voltage of 230 V.

P-1003566



Set of 60 Ecoflam Pellets

Pellets for environmentally friendly generation of an open flame on the grid of the LAB2 electrical burner.

P-1010255

Spirit Lamp

Made of metal, with a knurled screw for feeding the wick and cap for extinguishing the flame.

Contents: approx. 60 ml
 Dimensions: approx. 55mm x 70 mm diam.
 Weight: approx. 50 g

P-1003565

Wick (not shown)

Spare wick for the spirit lamp (P-1003565).

Length: approx. 100 mm

P-1001048



Experiment Topics:

- Determination of the refractive index of solid or liquid substances
- Determination of the relative density of liquids (degrees Brix)
- Determination of the sugar content
- Measurement using transmitted light, grazing incidence or total internal reflection
- Abbe refractometer



Analog Abbe Refractometer ORT 1RS

Easy-to-operate universal analog refractometer for efficient and extremely reliable usage. Liquid, solid or paste-like substances can all be analysed. Built-in scale allows for use in many applications and offers optimum safety for reading measurement results with precision. Includes thermometer.

Also included:

Calibration solution, calibration block, pipette, screwdriver and cleaning cloth.

Scales: Brix, refractive index

Measuring range: 0 – 95%, 1.3000 – 1.7000 nD

Accuracy: $\pm 0.1\%$, ± 0.0002 nD

Divisions: 0.25%, 0.0005 nD

Dimensions: approx. 180x90x240 mm³

Weight: approx. 1.95 kg

P-1021250



Hand-Held Refractometer HR901

Sturdy, user-friendly universal hand-held refractometer with selector switch for all measuring ranges. Movable prism fitting for sharply defined contour lines, direct and indirect light inlets for determination with both transparent and opaque substances. Includes thermometer.

Measuring range: 1.333 – 1.517 nD

Accuracy: 0.0005 nD

Scale divisions: 0.0005 nD

Thermometer: 6 – 36°C

P-1021249



Hand-Held Refractometer HRT32

Handy refractometer for determining the sugar content of fruit, must, juice, vegetables and other foods and in the analysis of coolant lubricants. Automatic temperature compensation increases the accuracy of measurements carried out at temperatures between 10° and 40°C.

Measuring range: 0 – 32% Brix

Accuracy: 0.2% Brix

Scale divisions: 0.2% Brix

Temperature compensation: automatic

P-1021440

Hand-Held Refractometer HRT62

Hand-held refractometer which is particularly easy to use for the analysis of chemicals and technical fluids, e.g. oils, grease, coolant fluids and lubricants. With automatic temperature compensation for precise measurements.

Measuring range: 28 – 62% Brix

Accuracy: 0.2% Brix

Scale divisions: 0.2% Brix

Temperature compensation: automatic

P-1021441





Monocular Course Microscope M100 LED

The course microscopes M100 are distinguished by their robust construction and ease of operation. They are equipped with three achromatic objectives as used in common practice and have a simple object stage with two clips for holding slides. They can be supplemented by means of a variety of spare parts and accessories. The LED lighting makes for uniform illumination of the object and avoids the problem of heat affecting the slide when viewed for extended periods. In addition, it lasts for a long time and eliminates the need to change bulbs. The microscopes are equipped with rechargeable batteries and can be used without a mains connection.

The monocular microscope M100 is also available equipped with a 20 W tungsten bulb instead of LED lighting. It operates from a 230 V, 50/60 Hz power supply and its order number is P-1005402.

P-1005406

Art. No.	P-1005406
Stand	All-metal stand, arm firmly connected with base, pinion knobs attached on both sides of the stand for coarse and fine focusing
Tube	Monocular inclined 45°, head rotation 360°
Eyepieces	Wide field eyepiece WF 10x 18 mm with pointer and eyepiece lock
Objectives	Revolving nosepiece with 3 achromatic objectives 4x / 0.10, 10x / 0.25, 40x / 0.65
Enlargement	40x, 100x, 400x
Object Stage	110 mm x 120 mm with 2 specimen clips
Illumination	Adjustable LED lighting integrated in base, power supplied by rechargeable battery, 100 to 240 V, 50/60 Hz charger
Condenser	Bright-field condenser N.A. 0.65, iris diaphragm, filter holder and blue filter
Dimensions	approx. 175x135x370 mm ³
Weight	approx. 2.9 kg
Supplied	Complete with dust cover



Binocular Microscope BE5

The microscope E5 stands out thanks to its

- Ergonomic design with 30° angled eyepiece
- Compact and robust construction
- Excellent mechanical and optical quality
- Ease of operation
- LED fibre optic illumination integrated into the base
- Ensures even illumination of the field of vision
- Prevents thermal effects from affecting the sample during prolonged examination
- Features a long operating life and makes lamp replacement superfluous

Besides the binocular eyepiece, the microscope model TE5 (P-1020251) also offers the option of connecting a camera for photographic and/or video documentation.

P-1020250

Art. No.	P-1020250
Stand	Robust, all metal stand with arm permanently connected to the base. Focussing by means of separate knobs for coarse and fine adjustment located on either side of the stand and operated by rack and pinion drive with ball bearings and retaining lever, adjustable stopper for protecting the object slides and objective. Resolution of fine focussing adjustment: 0.002 mm
Tube	Binocular head, 30° viewing angle, 360° rotatable head, viewing distance adjustable between 50 and 75 mm, ±5 dioptic compensation
Eyepieces	Pair of wide field plan eyepieces PL 10x 18 mm
Objectives	Inverted objective revolver with 4 achromatic objectives 4x / 0.10, 10x / 0.25, 40x / 0.65, 100x / 1.25 (oil)
Enlargement	40x, 100x, 400x, 1000x
Object Stage	x-y mechanical stage, 132 mm x 140 mm, with object guide and coaxial adjustment knobs perpendicular to the object stage, adjustment range 76 mm x 50 mm, accuracy 0.1 mm
Illumination	Adjustable LED lighting integrated in base, universal 100 to 240 V, 50/60 Hz power supply
Condenser	Abbe condenser N.A.1.25 with iris diaphragm, filter holder and blue filter
Dimensions	approx. 350x213x366 mm ³
Weight	approx. 8 kg
Supplied	Complete with dust cover



Digital Camera Moticam1
P-1021162



Digital Camera Moticam2
P-1021164

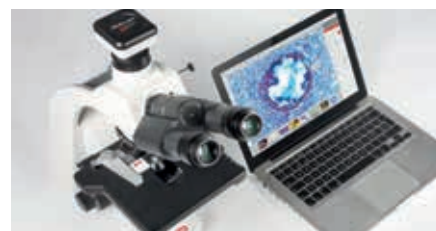

Moticam Digital Camera

Inexpensive color digital camera for direct connection to a PC or laptop computer via a USB interface. The camera can be attached directly to the ocular lenses of all current microscopes. No external power supply is needed since the camera is powered via USB. Includes: USB cable, calibration object holder, macro extension tube, focusable glass lens, 2 ocular adapters and software CD.

The Motic Images Plus 3.0 software stands out for its user-friendliness and offers the following functions (among others):

- Calibration function and white balance
- Real-time imaging
- Video recording
- Expansion of exposure under inadequate lighting conditions
- Digital image processing
- Measurement of dimensions of individual elements of the image or of whole groups of elements including calculation of area
- Spatial calibration (measurement of distance differential between two points)
- Intensity analysis for measurement of three-dimensional structures

Art. No.	P-1021162	P-1021164
Camera sensor	1/2.9" CMOS, color image	1/3" CMOS, color image
Pixel size	4.2 µm x 4.2 µm	3.2 µm x 3.2 µm
Sensitivity (V/Lux-sec)	4.6	1.0
Resolution	1280 x 720, 1 Mpixel	1600 x 1200, 2 Mpixel
Dynamic range	64.8 dB	61 dB
Output	mini USB	
Power supply	via USB interface 2.0	
Microscope adapter	2 adapters 30 mm and 38 mm, c-mount	
System requirements	Windows XP/Vista/7/8/10, MAC OS X and Linux	



Vision Viewer™

Robust, ultra high resolution desktop digital color camera for direct connection to a PC or notebook via a USB interface. Thanks to video head that can pivot and swivel via its flexible gooseneck, the camera can be easily and accurately connected, e.g. to microscopes and telescopes, or directed towards visual material, running processes or items of scientific or technical interest so that they can be viewed on a monitor. The heavy, triangular base ensures the necessary stability. Audio recordings are possible via a microphone equipped computer. An external power supply is not necessary as the camera is powered via the USB connection. Includes microscope adapter and Applied Vision™ software. Compatible with interactive whiteboards. The Applied Vision™ software for picture recording, reproduction and processing is characterized by its user friendliness and features e.g.: full screen, real time video; still frame recording; time-lapse recording; internet streaming; can be used in local network; zoom function; brightness, contrast control and positive/negative image display; drawing tools: organizer/memo function; choice of background; creation of image collages; comparison of two adjacent images; measurement of the distance between 2 points or the area of a circle; exporting data; compatible with Windows, Mac and Linux: free software updates; unlimited local licences.

Characteristics:

Image digitization:	CMOS 3.2 Mpixel
Photosensitivity:	20 lux
Output signal:	digital / USB 2.0
Resolution:	2048x1536
Live video:	up to 30 images per second
Focus:	manual
White balance:	automatic / manual
Microscope adapter:	34.5 mm built-in and 28 mm
Power supply:	via USB
Cable:	USB connecting cable, approx. 150 cm
Dimensions:	approx. 180x180x640 mm ³
Weight:	approx. 1.7 kg

P-1003436

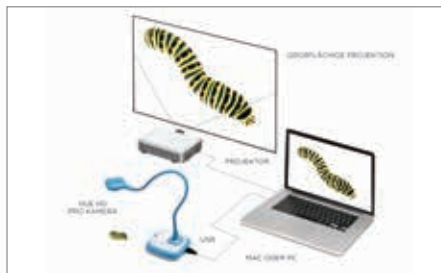

Digital Camera HUE HD Pro

This inexpensive, innovative and simple-to-use color video camera with HD resolution is a perfect instrument for a large number of possible applications including presentation of objects, images and text in video and sound recordings, for observation of ongoing processes, for establishing video portfolios, for sending video e-mails and chatting with schools in other countries via software such as Skype™. It can be attached to a stable camera tripod or directly into a USB socket on a laptop and makes it possible to take images of full A4 size thanks to its wide-angle lens. Compatible with interactive whiteboards with a USB port. "HUE Intuition", specially developed for the camera, is user-friendly and provides easy access to all the camera's functions, including sound and image recording, image processing, automatic timer recordings and Skype™ support.

System requirements: Windows XP, 7, 8, 10 or Mac OS X 10.5+, suitable for 32-bit- and 64-bit versions of Windows 10, 8 and 7 and for Mac OS X, 1.5 GHz processor; 512 MB RAM (1 GB recommended), USB port.

P-1021167

Software "HUE Animation"

Stop-motion animation software for recorded animated films with a simple and user-friendly user interface especially developed for students and teachers. For use with the HUE HD Pro digital camera or other USB cameras for Windows and Mac OS X.

Simply take a few photographs, devise a story, add background sound effects, using paint tools to enhance the pictures, make a time-lapse film and share it on a video platform. Includes comprehensive manual.

System requirements: Windows XP, 7, 8, 10 or Mac OS X 10.5, minimum 512 MB RAM, up-to-date graphic card driver with support for OpenGL 2.0. Mac users require an Intel processor.

P-1021252



Digital Camera for Microscopes, 2 Mpixel

Inexpensive digital color camera which can be placed directly on any modern microscope tube. The user-friendly "ImageView" software allows, among other things, for real-time video and still pictures, extensive evaluation and measurement options, image processing etc. Software in German, English, French, Russian, Polish, Turkish, Japanese, Indonesian, Chinese. Includes 2 microscope adapters 30 mm diam. and 30.5 mm diam.

- Camera sensor: 1/3,2" CMOS, 2 Mpixel
- Power supply: via USB interface, USB cable 1.45 m in length
- System requirements: Windows XP/Vista/7/8/10, MAC OSX and Linux
- Dimensions: approx. 40 mm x 27 mm diam.
- Weight: approx. 30 g

P-1021376





Mechanical Balance 610

- Solid, all-metal construction
- Notched positions for sliding weights on three sliding beams
- Captive sliding weights
- Magnetic damping
- Zero point adjustment
- Extensible scale range

Scale range: 0 – 610.0 g (2610.0 g with additional weights)

Readability: 0.1 g

Sliding weight: 0.1 – 10 g (front), 10 g – 100 g (rear),
100 – 500 g (center)

Plate diameter: 150 mm

P-1003419

Additional Weights for Mechanical Balance (not shown)

Additional weights to extend the scale range of the mechanical balance 610 (P-1003419).

Weights: 1x 0.5 kg, 2x 1 kg

P-1014616

! Advantages:

Top quality

- Precision
- High resolution
- Easy to read

Analytical Scales AES 200

Precision analytical scales with automatic adjustment mechanism and high resolution. Tough metal casing with complete glass windscreen, large graphic display and RS232 and USB port. The scales offer practically every function needed in laboratories:

- Counting items
- Percentage weights
- Switching between different units
- Capacity display for weight range
- GLP/ISO protocols
- Programmable 4-digit ID number
- CAL adjustment program for setting accuracy
- Pipette calibration program
- Dosing mode
- Alibi memory and internal memory

Max. measuring range: 220 g

Precision: 0.1 mg

Reproducibility: 0.2 mg

Linearity: ± 0.2 mg

Time to settle: 4 s approx.

Item counting

Minimum weight: 0.5 mg

References: 10, 20, 50, freely selectable

Weight display: LCD, 17 mm

Weighing platform: 85 mm diam.

Power supply: 13.8 V DC power supply,
mains voltage 110 – 230 V, 50/60 Hz

Dimensions: approx. 206x335x335 mm³

Weight: approx. 5.4 kg

P-1018347



Mechanical Balance 311

- Solid, all-metal construction
- Notched positions for sliding weights on four sliding beams
- Captive sliding weights
- Magnetic damping
- Zero point adjustment

Scale range: 0 – 311.00 g

Readability: 0.01 g

Sliding weight ranges: 0.01 – 1 g (1st beam), 1 – 10 g (2nd beam),
10 – 100 g (3rd beam), 100 – 200 g (4th beam)

Pan diameter: 100 mm

P-1003421





Advantages:

- High quality overload protection
- Easy to read
- Rapid weighing
- High resolution
- Powered by batteries or from the mains
- Hook for weighing items underneath the scales



Electronic Scales Scout SKX

Precision scales with removable stainless steel weighing platform for weighing by mass, determining moles of substance and for establishing density. Also includes transportation lock, mechanical and software overload/underload protection, stability indicator, auto tare, low battery indicator, auto shut-off, user selectable printing options, user-selectable communication settings and calibration weight.

Electronic Scale Scout SKX 420 g (not shown)

P-1020859

Electronic Scale Scout SKX 620g

P-1020860

	P-1020859	P-1020860
Weight range	420 g	620 g
Accuracy	0.01 g	0.1 g
Display	LCD, 20 mm	
Weight ranges	g, kg, N, oz, lb, lb:oz	
Scale pan	120 mm diam.	170x140 mm ²
Dimensions	approx. 202x224x54 mm ³	
Weight	approx. 1 kg	



Precision Scale PCB 2000

Inexpensive precision scales for weighing, item counting, differential weighing, percentage calculations, suspended weights. With PRE-TARE function for storing weights of empty calibrated vessels, formula function for addition of weights of formula ingredients, freely programmable weight unit, GLP/ISO logging of weight data, scale adjustment etc., with date, time, identification number and hold function (for weighing animals) which enables an average to be calculated for stable weight measurements. Removable stainless steel weighing platform.

- Weight range: 2000 g
- Reading accuracy: 0.1 g
- Calibration: via external weight
- Weighing platform: 130x130 mm²
- Display: LCD, 15 mm
- Power supply: mains adapter or 9 V block battery (not included)
- Data interface: RS-232
- Dimensions: approx. 163x245x79 mm³
- Weight: approx. 1.4 kg

P-1021079



Electronic Scales

Universal scales in robust plastic casing, with easy-clean foil keyboard. Menu functions, easy selection using two buttons. High-resolution, easy-to-read LCD display, overload and underload display, battery or mains operation optional. Automatic shutdown after five minutes in battery operation. Batteries included.

Electronic Scale 200 g

P-1003433

Electronic Scale 5000 g (not shown)

P-1003434

	P-1003433	P-1003434
Scale range:	0 – 200,0 g	0 – 5000 g
Accuracy:	0.1 g	1 g
Weight units:	g/ lb:oz	
Counter-balancing range:	subtractive, entire weight range	
Power supply:	3 AA alkaline batteries	
Dimensions:	approx. 193x135x39 mm ³	
Weight:	approx. 470 g	

LAB MATERIAL

Laboratory Jacks

Height adjustable table with continuously variable extension mechanism for raising experiment equipment. May be fixed in place via wing nuts.



P-1002941



P-1002942
P-1002943

Art. No.	Designation	Maximum load	Tabletop	Height of table	Weight
P-1002943	Laboratory Jack I	30 kg	320x220 mm ²	65 – 250 mm	2.6 kg
P-1002941	Laboratory Jack II	40 kg	200x200 mm ²	70 – 260 mm	2.3 kg
P-1002942	Laboratory Jack III	50 kg	160x130 mm ²	60 – 250 mm	1.2 kg



P-1018874

Stand with H-Shaped Base

Provides a firm base for large and extensive structures, with six clamping positions for stand rods up to 12 mm diameter.

Max. stand area: approx. 550x280 mm²

Weight: approx. 1.7 kg

P-1018874

P-1001044



Stand Base, A-Shaped

Adjustable duplex tripod base, extremely stable, for holding two rods of 4 up to 15 mm diameter.

Art. No.	Leg length	Weight
P-1001044	195 mm	1.4 kg
P-1001043	270 mm	2.6 kg



P-1002835

Tripod Stand

Adjustable duplex tripod base, extremely stable, for holding two rods of up to 16 mm diameter.

Art. No.	Leg length	Weight	Distance between rods
P-1002835	150 mm	1450 g	95 mm
P-1002836	185 mm	1850 g	135 mm

P-1002834



Barrel Foot, 1 kg

Heavy base for holding rods of up to 13 mm diameter. Made of powder-coated cast iron.

P-1002834

P-1001046



P-1001045



Barrel Foot

Heavy base to accommodate stand rods up to 12 mm in diameter and rectangular plates of up to 10 mm or 12 mm thickness. Made of painted cast iron.

Art. No.	Weight	Height	Diameter
P-1001045	0.9 kg	56 mm	64 mm
P-1001046	0.5 kg	47 mm	54 mm

Bosshead

Bosshead for connecting rods of up to 16 mm diameter. Powder-coated zinc die-casting, 110 g. Nickel-plated steel screws.

P-1002827

Cross-Bosshead

Cross-bosshead for connecting rods of up to 20 mm diameter. Powder-coated zinc die-casting, 130 g. Nickel-plated steel screws.

P-1002831

Clamp with Hook

Clamp with hook for attaching rods of up to 16 mm diameter. Powder-coated zinc die-casting, 93 g. Nickel-plated steel screws.

P-1002828

Clamp with Jaw Clamp

Stand clamp with jaw clamp for attaching rods up to 16 mm diameter. Powder-coated zinc die-casting, 190 g. Clamp with cork lining.

Clamping width: 20 – 40 mm

P-1002829

Universal Jaw Clamp

Clamp with cork lining. Unpainted zinc die-casting, 180 g.

Clamping width: 0 – 80 mm

P-1002833

Adjustable Double Clamp

Double clamp with two grippers which can be rotated by 360° with respect to one another for connecting rods of up to 16 mm in diameter.

Powder coated zinc die casting, 180 g. Nickel-plated steel screws.

P-1017870

Multiclamp

Universal clamp for attachment of rods up to 13 mm diameter and for holding plates, rulers, etc. of up to 13 mm thickness in a multitude of alignments. Nickel-plated steel screws.

P-1002830

Table Clamp

Table clamp for vertically attaching rods of up to 13 mm to tabletops.

Powder-coated aluminum alloy, 350 g

Clamping width: 0 – 60 mm

P-1002832



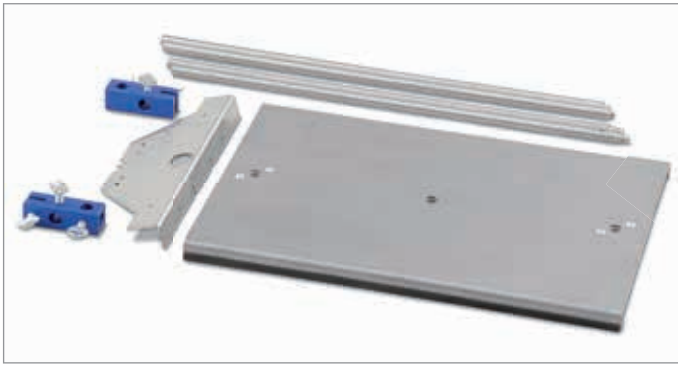

Stand Equipment “Mechanical Oscillations”

Stand equipment for easy, understandable and stable assemblies, e.g. for investigating mechanical oscillations and waves using the sensors from Sensors “Mechanical Oscillations” (P- 1012850 or P- 1012851). Including base plate as non-tilting base to accommodate the stand rods, two double clamps and tie bar. The tie bar serves as multi-function holder for fitting between stand rods on the base plate in order to build set-ups featuring the dynamic force sensors from Sensors “Mechanical Oscillations”.

Base plate: approx. 345x240x16 mm³
 Stand rods: approx. 400 mm x 10 mm diam.

Contents:

- 1 SW Base plate
- 2 Stand rods with internal and external thread
- 2 Stand rods with external thread
- 2 SW Double clamps
- 1 SW Tie bar

P-1012849

Additionally recommended:

- P-1012848 Steel Rod 280 mm**
- P-1012847 Steel Rod 400 mm**

Holder for Light Barrier

Holder to allow a light barrier (P-1000563) to be used with the free-fall apparatus (P-1000738).

P-1018448



Drilled Rod

Plastic rod with six lateral bore holes and one axial bore hole for the attachment of components with 4 mm plugs.

Length: 250 mm
 Diameter: 12 mm
 Bore hole spacing: 19 mm and 50 mm
 Bore hole diameter: 4 mm

P-1002710



P-1002934

P-1012847

P-1002937

P-1012848

Stainless Steel Rods

Art. No.	Length	Diameter
P-1002932	100 mm	12 mm
P-1002933	250 mm	12 mm
P-1002934	470 mm	12 mm
P-1002935	750 mm	12 mm
P-1002936	1000 mm	12 mm
P-1002937	1500 mm	12 mm
P-1012848	280 mm	10 mm
P-1012847	400 mm	10 mm



Holder for Plug-in Components

Holding rod with 4-mm connector sockets to accommodate and connect components with two plugs matching a 19-mm or 50-mm grid or conductor loops for verifying the Biot-Savart law. Suitable for both 4-mm laminated plugs as well as 4-mm safety plugs.

Max. continuous current: 25 A
 Diameter of rod: 10 mm
 Dimensions: approx. 110x20x135 mm³
 Weight: approx. 120 g

P-1018449

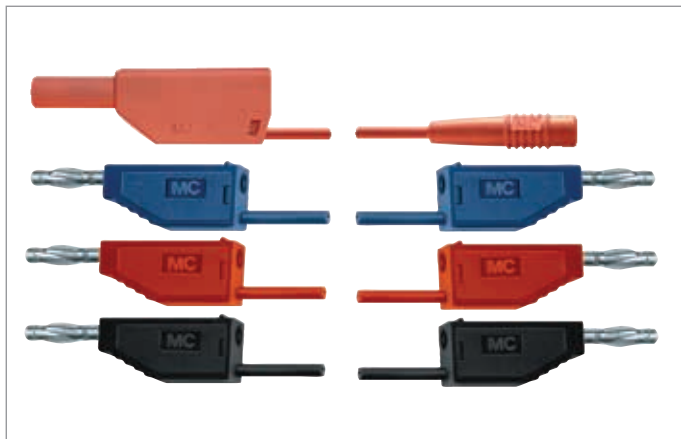

Set of Experiment Leads for Electron Tube Experiments

Set of 18 copper leads with highly flexible PVC insulation for all connections to series D electron tubes.

Wire cross-section: 1 mm²
 Max. continuous current: 19 A
 Plug and jack: 4 mm (nickel-plated)

P-1002847

Quantity	Length	Colour	Connection
3	75 cm	red	Safety jack/plug
4	75 cm	blue	Plug/plug
2	75 cm	black	Plug/plug
2	50 cm	blue	Plug/plug
5	25 cm	black	Plug/plug
2	25 cm	red	Plug/plug

Experiment Lead, Plug and Socket

Experiment lead with 4 mm laminated plug and 4 mm socket. 75 cm long, colour red.

Wire cross-section: 1 mm²
 Max. continuous current: 19 A

P-1002838

Experiment Lead, Safety Plug and Socket

Experiment lead with stackable 4 mm safety-grade laminated plug and 4 mm socket. 75 cm long, colour red.

Wire cross-section: 1 mm²
 Max. continuous current: 19 A

P-1002839

Set of 10 Crocodile Clips 4 mm, Not Insulated

Not insulated test clips with 4 mm sockets for accepting 4 mm-test leads or any other 4 mm-Multilam plug. Connection also possible with screw clamp or soldering.

P-1019219

Pair of Experiment Leads, 75 cm

Set of two copper leads with highly flexible PVC insulation, 75 cm long, black, with cascable 4 mm laminated plugs at both ends.

Conductor cross-section: 1 mm²
 Voltage: Safety extra low voltage
 Max. continuous current: 19 A

P-1002850

► For a reliable connection

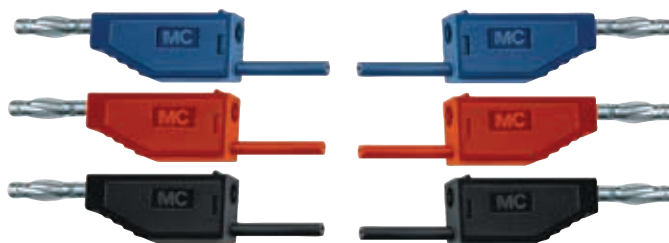

Set of 15 Experiment Leads, 75 cm

Set of 15 copper leads with highly-flexible PVC insulation, 75 cm long, with stackable 4 mm laminated plugs at both ends. Five leads in each of the colours red, black and blue.

Voltage: Safety extra low voltage
 Plugs and sockets: Nickel-plated

Art. No.	Conductor cross-section	Max. continuous current
P-1002840	1 mm ²	19 A
P-1002841	2.5 mm ²	32 A

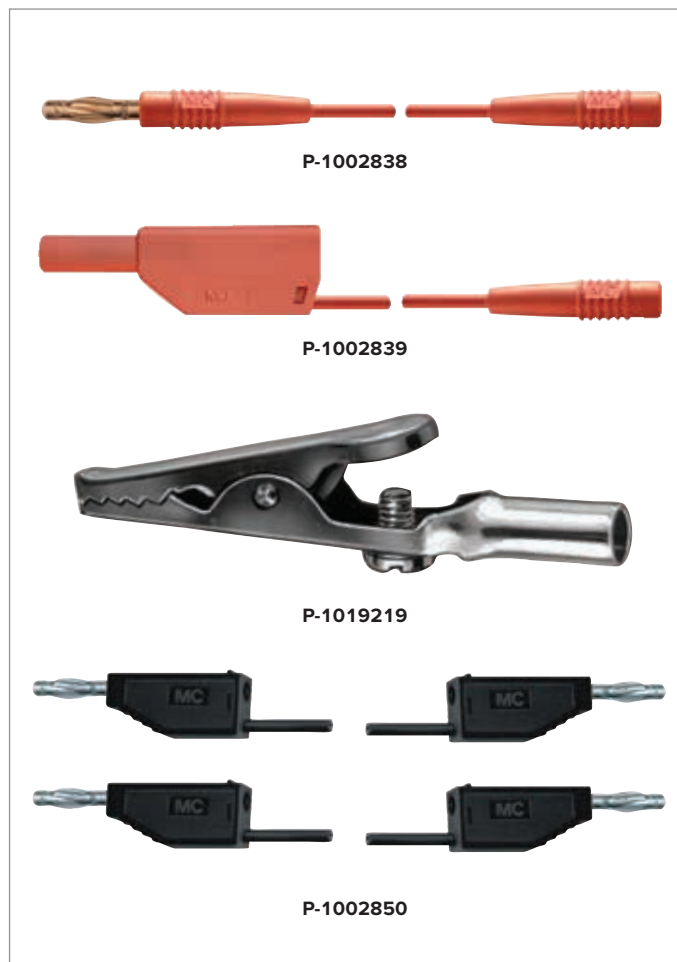



Set of 6 Safety Crocodile Clips 4 mm

Fully insulated safety crocodile clips (3x red, 3x black) with 4 mm safety socket for accepting 4 mm safety test leads or any other 4 mm Multilam plug.
P-1019218



Set of Fuses

Set of fuses, including 105 fast-acting fuses of a high switching capacity and 135 slow-acting fuses of a low switching capacity. Stored in a box.

Dimensions: 5 mm diam. x 20 mm
 Rated voltage: 250 V

Type SP:

Material: Glass tube
 Time response: Fast
 Switching capacity: 1000 A @ 250 V
 Assortment: 1 A (15 units); 3.15 A; 6.3 A; 10 A (30 units in each case)

Type FST:

Material: Ceramic tube
 Time response: Slow
 Switching capacity: 35 A @ 250 V
 Assortment: 0.5 A; 1 A; 1.25 A; 1.6 A; 2 A; 2.5 A; 3.15 A; 6.3 A; 10 A (15 units each)

P-1012873

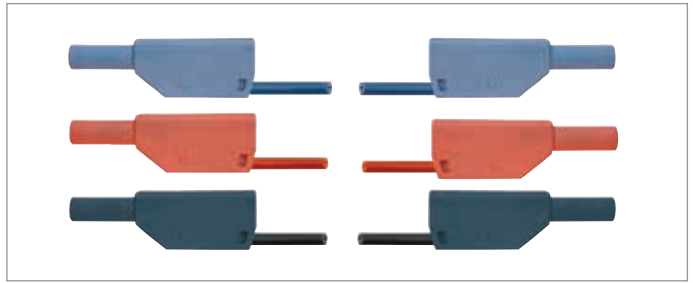

Set of 15 Safety Experiment Leads, 75 cm

Set of 15 copper leads with highly-flexible PVC insulation, 75 cm long, with stackable 4 mm safety laminated plugs at both ends. Four leads in each of the colours red, black and blue, and one lead in each of the colours green, brown and yellow-green.

Wire cross-section: 2.5 mm²
 Voltage: Low voltage
 Max. continuous current: 32 A

P-1002843

Safety Experiment Leads, 75 cm (not shown)

Copper leads in highly flexible PVC insulation, 75 cm long, black, with stackable 4 mm safety laminated plugs at both ends.

Conductor cross-section: 2.5 mm²
 Voltage: Safety extra low voltage
 Max. continuous current: 32 A

Pair of Safety Experiment Leads, 75 cm, black

P-1002849

Pair of Safety Experiment Leads, 75 cm, red

P-1017716

Pair of Safety Experiment Leads, 75 cm, blue, red

P-1017718

Set of Three Safety Experiment Leads, 75 cm, yellow/green, blue, black

P-1017719

Set of Three Safety Experiment Leads for Free-Fall Apparatus (not shown)

Set of three copper leads with highly flexible PVC insulation for connecting to free-fall apparatus (P-1000738), with stackable 4 mm safety laminated plugs at both ends. Two leads 75 cm long, one red and one black. One green lead, 150 cm long.

Wire cross-section: 2.5 mm²
 Voltage: Low voltage
 Max. continuous current: 32 A

P-1002848



Pair of High-Voltage Cables, 150 cm

Set of two copper leads sheathed in highly flexible PVC, 150 cm long with 4-mm safety plugs at either end housed in rigid insulating sleeves. One red cable and one black.

Cable cross section: 0.5 mm²
 Voltage: Up to 5 kV

P-1002851

► For high-frequency signals

T-Piece, BNC

T-piece for connecting two high-frequency patch cords to one BNC jack.

P-1002752



P-1002752

Adaptor, BNC Plug/4 mm Jacks

Crossover from a BNC plug to 4 mm jacks with 19 mm spacing.

P-1002750

P-1002749



Adaptor, BNC Jack/4-mm-Plugs

Crossover from a BNC jack to 4 mm plugs with 19 mm spacing.

P-1002751



P-1002751

BNC Patch-Cord Connector

Coupling at either end with a BNC jack for connecting high-frequency patch cords.

P-1002749

P-1002750

HF-Patch Cord

Shielded patch cords for low loss, low capacitance transmission of high frequency signals. Equipped at either end with a BNC plug.

Impedance: 50 Ω

Length: 1 m

P-1002746



P-1002746



P-1010181

Adaptor, BNC Plug/4 mm Safety Jacks

Crossover from a BNC plug to 4 mm safety jacks with 19 mm spacing.

P-1010181



Ultrasonic Adaptor Lead

Adaptor lead for rectifying high-frequency output signals from the ultrasonic electronic control unit in order to conduct measurements with any DC voltmeter. The ultrasonic electronic control unit is part of ultrasonic equipment sets used in student experiments.

Input: BNC plug

Output: 2 x 4-mm plugs

Length: 65 cm

Weight: approx. 20 g

P-1018750



HF Patch Cord, BNC/4 mm Plug

Shielded patch cord for low loss, low capacitance transmission of high frequency signals. Lead with a BNC plug at one end and two 4 mm plugs at the other end.

Impedance: 50 Ω

Length: 1 m

P-1002748

Plane Mirror

Glass mirror, ground edges.

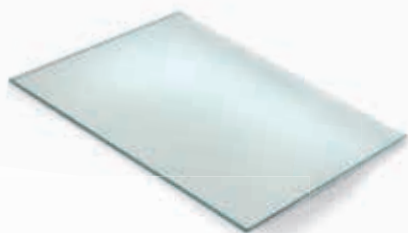
Dimensions: approx.
170x130 mm²**P-1003190****P-1002868****P-1002869****Watch Glass Dishes**

Made of thin-walled soda-glass, ground rim. Diameter 80 mm or 120 mm.

Art. No.	Designation
P-1002868	Set of 10 Watch Glass Dishes, 80 mm
P-1002869	Set of 10 Watch Glass Dishes, 120 mm

P-1002873**P-1002872****Beakers, 600 ml**

Set of 10 beakers made of borosilicate glass. With scale, 100 ml divisions and spout.

Art. No.	Designation
P-1002872	Set of 10 Beakers, Low Form
P-1002873	Set of 10 Beakers, Tall Form

Vessel with Overflow

Vessel with overflow, 275 ml, made of acrylic.

P-1003518**DIN-B Burette with Schellbach Stripe, 10 ml**

Burette tube for measuring small amounts of liquid with Schellbach stripe and tap at the side with standard ground (NS) glass connector and cock plug.

Volume: 10 ml
Scale divisions: 0.02 ml
Error limits: Class B**P-1018065****Graduated Cylinder, 250 ml**

Graduated cylinder made of borosilicate glass. Tall form with spout and hexagonal base.

Scale: 250 ml
Divisions: 2.5 ml**P-1010114****Free-Standing Cylinder**

Non-graduated cylinder made of Duran glass. With round base and coarse ground rim.

Height: 300 mm
Diameter: 40 mm**P-1002871****Graduated Cylinder, 100 ml**

Graduated cylinder made of Duran glass. Tall form with spout with hexagonal base.

Scale: 100 ml
Divisions: 1 ml**P-1002870****Cuvette, Rectangular, 80x30x80 mm³**

Plane-parallel cuvette of acrylic with highly-polished optical surfaces for investigating the paths of light beams in liquids.

Dimensions: 80x30x80 mm³**P-1003534****Plastic Trough (not shown)**

Transparent plastic trough.

Dimensions: 70x130x85 mm³**P-4000036**

Silicone Tube

Silicone, transparent, 1 m long.
 Internal diameter: 6 mm
 Wall thickness: 2 mm
P-1002622

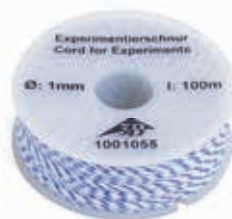

Cord for experiments

Plaited hemp string on a bobbin. For a variety of uses, e.g. setting up block and tackle using pulleys P-1003216 to P-1003223 or making a pendulum with bobs P-1003230.

Length: 100 m
 Diameter: 1 mm
 Maximum tension: 50 N
P-1001055



Cord, 100 m

100 m length of hemp string, black, rolled onto bobbin.

P-1007112

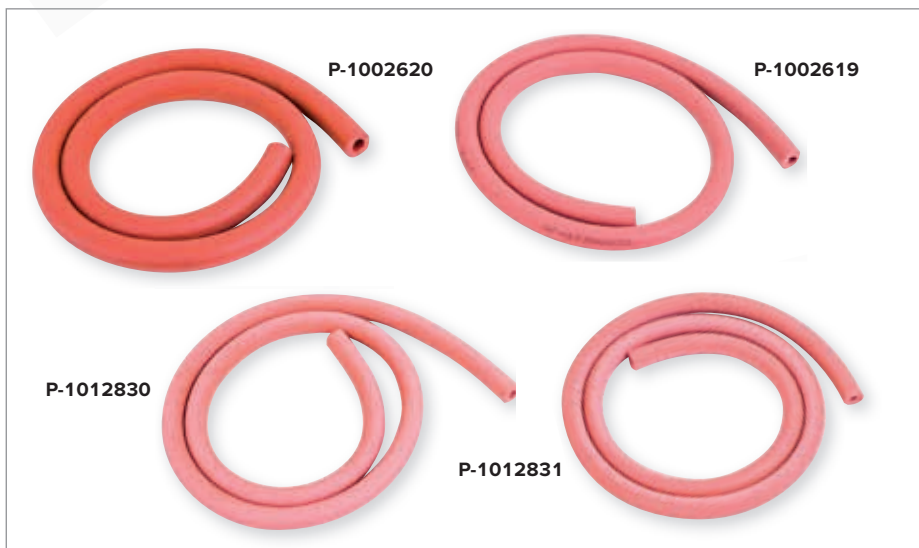

Vacuum Hoses

Vacuum hoses made of natural rubber according to DIN 12865. Colour red.

Art. No.	Length	Internal diameter	Wall strength	Temperature range
P-1012831	1 m	4 mm	4 mm	-30° up to + 85°
P-1012830	1 m	6 mm	4 mm	-30° up to + 85°
P-1002619	1 m	8 mm	5 mm	-30° up to + 85°
P-1002620	1 m	10 mm	5 mm	-30° up to + 85°



Blue Food Colouring

Powdered food colouring in bottle for use in 30-ml colouring solutions for colouring water in demonstration experiments. One drop of the solution is sufficient to colour 50 ml of water.

P-1000793

Pellets

Granules for filling calorimeters.



Aluminium Shot, 100 g
P-1000832



Copper Shot, 200 g
P-1000833



Glass Shot, 100 g
P-1000834



Glycerine

250 ml of glycerine in aqueous solution for experiments on viscosity. In glass bottle

Concentration: 85%

P-1007027

Description	Art. No.	Page	Description	Art. No.	Page
"Principles of the Solar Thermal Collector", Set	P-1000839	120	- B -		
"Physical Pendulum", Supplementary Kit	P-1012853	78...79	Balance Weights		56
"String Pendulum", Supplementary Kit	P-1012854	78...79	Ball and Ring	P-1003382	130
"Wilberforce Pendulum", Supplementary Kit	P-1012844	78...79	Ball with Ring	P-1000831	130
€Lab	P-1021478	41	Ballistic Pendulum	P-1002656	71
3B Plug-in Component System		206	Balloons, Set of 100	P-1010125	90
3B Student Kit		6	Band Wave Device	P-1000808	101
- A -			Bar Magnet, AlNiCo, 70 mm	P-1003554	214
AC/DC Power Supply 0 – 12 V, 3 A (115 V, 50/60 Hz)	P-1021092	272	Bar Magnets, 80 mm, Pair	P-1003085	214
AC/DC Power Supply 0 – 12 V, 3 A (230 V, 50/60 Hz)	P-1021091	272	Bar Magnets, AlNiCo, 60 mm, Pair with Two Iron Yokes	P-1003086	214
AC/DC Power Supply 0 – 12 V, 3 A, stab. (115 V, 50/60 Hz)	P-1001006	272	Baroscope	P-1003169	91
AC/DC Power Supply 0 – 12 V, 3 A, stab. (230 V, 50/60 Hz)	P-1001007	272	Barrel Foot, 1000 g	P-1002834	296
AC/DC Power Supply 0 – 20 V, 0 – 5 A (230 V, 50/60 Hz)	P-1003562	272	Barrel Foot, 500 g	P-1001046	296
AC/DC Power Supply 0 – 30 V, 5 A (230 V, 50/60 Hz)	P-1002769	272	Barrel Foot, 900 g	P-1001045	296
AC/DC Power Supply 0 - 30 V, 6 A (115 V, 50/60 Hz)	P-1008692	231, 293	Basic Equipment Set for the X-Ray Apparatus	P-1000665	258c
AC/DC Power Supply 0 - 30 V, 6 A (230 V, 50/60 Hz)	P-1003593	231, 273	Basic Experiment Board (115 V, 50/60 Hz)	P-1000572	205
AC/DC Power Supply 1/ 2/ 3/ ... 15 V, 10 A (230 V, 50/60 Hz)	P-1008691	273	Basic Experiment Board (230 V, 50/60 Hz)	P-1000573	205
Accelerometer 25 x g	P-1021675	43	Basic Set Bragg	P-1008508	258c
Accelerometer 5 x g	P-1021674	43	Basic Set for Kröncke Optical System (115 V, 50/60 Hz)	P-1009931	32
Accessories for Faraday Effect	P-1012861	173	Basic Set for Kröncke Optical System (230 V, 50/60 Hz)	P-1009932	32
Accessories for Kinetic Gas Theory	P-1000704	139	Basic Student Experiments		34
Accessories for Rope Waves	P-1008540	100	Battery Holder in 3B Box	P-1010192	198...199
Accessories for Spring Oscillations	P-1000703	100	Battery Holder, P4W50	P-1012994	209
Accessory Set for the Interferometer	P-1002652	183	Beakers, Low Form, Set of 10	P-1002872	302
Achromatic Objective 10x / 0.25	P-1005408	156	Beakers, Tall Form, Set of 10	P-1002873	302
Acoustics Kit	P-1000816	13	Beam Balance with Metal Bridge	P-1021824	57, 83
Acrylic Body with Drilled Holes	P-1002589	115	Bench Scales, Harvard Junior	P-1012872	57
Adaptor Cables 4-mm/2-mm plug, Pair of	P-1017899	128	Binocular Microscope BE5	P-1020250	291
Adaptor Flange DN 16 KF / NS 19/26	P-1002929	93	Bio-Amplifier (115 V, 50/60 Hz)	P-1020600	267...269
Adaptor Flange DN 16 KF / Shaft 12 mm	P-1002928	93	Bio-Amplifier (230 V, 50/60 Hz)	P-1020599	267...269
Adaptor, BNC Jack/4-mm-Plugs	P-1002751	301	Bio-Measurement Interface	P-1020602	267...269
Adaptor, BNC Plug/4 mm Jacks	P-1002750	301	Block for Friction Experiments	P-4003876	60
Adaptor, BNC Plug/4 mm Safety Jacks	P-1010181	301	Blue Food Colouring	P-1000793	87, 303
Additional Coil for Tesla Transformer	P-1000967	231	BNC Patch Cord Connector	P-1002749	301
Additional Weights f. Mechanical Balance	P-1014616	294	Board for Laser Ray Box	P-1003056	148
Adjustable Double Clamp	P-1017870	297	Bodies for Air Resistance and Buoyancy Experiments, Set	P-1000760	94
Adjustable Slit K	P-1008519	150...151	Bosshead	P-1002827	297
Adjustable Slit on Stem	P-1000856	158	Boyle-Mariotte Apparatus	P-1017366	140
Aerodynamics		94	Bragg Drive	P-1012871	258d...e
Air Cushion Platform with Inkjet Pucks	P-1021623	66...67	Brass Wire 0.3 mm / 50 m	P-1000959	196
Air Flow Apparatus	P-1000765	95	Bravais Lattices, Set of 14	P-1012837	249
Air flow Generator (115 V, 50/60 Hz)	P-1000605	65, 94	Breast Model with Benign Tumor	P-1000345	116
Air flow Generator (230 V, 50/60 Hz)	P-1000606	65, 94	Bulb E14, 12 V, 25 W	P-1006858	204
Air Track	P-1021090	64	Bulbs E10, 1.3 V, 60 mA, Set of 10	P-1010199	197
Alcohol Meter	P-1002875	84	Bulbs E10, 12 V, 100 mA, Set of 10	P-1010140	197
Alignment Laser Diode	P-1008634	184...187	Bulbs E10, 12 V, 500 mA, Set of 10	P-1010141	197
Aluminium Calorimeter	P-1017897	128	Bulbs E10, 3.5 V, 150 mA, Set of 10	P-1010142	197
Aluminium Shot, 100 g	P-1000832	303	Bulbs E10, 3.5 V, 200 mA, Set of 10	P-1010143	197
Aluminium Test Block with Protractor Scale	P-1002585	114	Bulbs E10, 3.8 V, 300 mA, Set of 10	P-1010195	197
Amici Direct Vision Prism	P-1002862	167	Bulbs E10, 4 V, 40 mA, Set of 10	P-1010196	197
Ammeter, AC	P-1002788	280	Bulbs E10, 6 V, 1 A, Set of 10	P-1010198	197
Ammeter, DC	P-1002786	280	Bulbs E10, 6 V, 100 mA, Set of 10	P-1010145	197
Amplifiers		287	Bulbs E10, 6 V, 350 mA, Set of 10	P-1010144	197
Analog Abbe Refractometer ORT 1RS	P-1021250	179, 290	Bulbs E10, 6 V, 50 mA, Set of 10	P-1010197	197
Analogue Multimeter ESCOLA 100	P-1013527	281	Buoyancy		83
Analogue Multimeter ESCOLA 30	P-1013526	281	Buoyancy Apparatus	P-1000791	83
Analogue Oscilloscope, 2x20 MHz (230 V, 50/60 Hz)	P-1008695	279	Button on 3B Box	P-1010146	198...199
Analytical Scales AES200 (230 V, 50/60 Hz)	P-1018347	294	- C -		
Apparatus for Investigation of Capillary Effects	P-1003510	87	Calcite Crystal	P-5006663	167
Apparatus for Measuring Young's Modulus	P-1018527	89	Cadmium Lamp with Accessories	P-1021366	252...253
Archimedes' Beaker	P-1021647	83	Calcite Crystal	P-5006663	167
Areometers, Set of 3	P-1003012	84	Callipers Model	P-1010214	53
Arm Phantom Set	P-1012880	118	Callipers S	P-1010217	52
Assembly Kit "Bell, Relay and Bimetallic Switch"	P-1000994	204	Callipers, 150 mm	P-1002601	52
Atomic and Nuclear Physics		246	Calorimeter 200 ml	P-1000823	128
Auxiliary Coil	P-1000645	236	Calorimeter Cylinder, Al	P-1003254	129
			Calorimeter Cylinder, Brass	P-1003255	129
			Calorimeter Cylinder, Cu	P-1003256	129
			Calorimeter Cylinder, Steel	P-1003257	129
			Calorimeter Cylinders, Set of 4	P-1003253	129
			Calorimeter with Heating Coil, 150 ml	P-1000822	129
			Calorimeter with Heating Coil, Pluggable, 1200 ml	P-1021155	129
			Calorimeters		129



Description	Art. No.	Page	Description	Art. No.	Page
Capacitance Decade	P-1013906	204	Colour Filters, Secondary Colours, Set of 3	P-1003186	165
Capacitance Decade 0.1 μF	P-1002736	201	Colour Filters, Set of 7	P-1003084	165
Capacitance Decade 1 μF	P-1002737	201	Colour Mixing Device	P-1021719	171
Capacitor 0.1 μF , 100 V, P2W19	P-1012953	206	Colour Mixing, Equipment Set	P-1003189	171
Capacitor 0.22 μF , 250 V, P2W19	P-1012945	206	Combined Holder for Hall Effect	P-1019388	266
Capacitor 0.47 μF , 100 V, P2W19	P-1012954	206	Communicating Tubes	P-1003509	87
Capacitor 1 μF , 100 V, P2W19	P-1012955	206	Compass	P-1003093	217
Capacitor 1 nF, 100 V, P2W19	P-1012949	206	Compass Magnet with Plastic Bowl	P-1003096	215
Capacitor 10 μF , 35 V, P2W19	P-1012957	206	Complete Fine Beam Tube System T	P-1013843	245
Capacitor 10 nF, 100 V, P2W19	P-1012952	206	Component Balance	P-1000761	94
Capacitor 100 μF , 35 V, P2W19	P-1012959	206	Component Holder	P-1003203	158
Capacitor 100 pF, 160 V, P2W19	P-1012947	206	Computer Aided Experimentation		37
Capacitor 1000 μF , 35 V, P2W19	P-1017806	206	Concave Lens K, $f = -100$ mm	P-1009864	150...151
Capacitor 2.2 μF , 63 V, P2W19	P-1012956	206	Concave Lens K, $f = -500$ mm	P-1009865	150...151
Capacitor 2.2 nF, 160 V, P2W19	P-1012950	206	Concave Lens N, $f = -100$ mm	P-1000844	152
Capacitor 22 nF, 100 V, P2W19	P-1012943	206	Concave Lens on Stem $f = -100$ mm	P-1003028	157
Capacitor 2200 μF	P-1000689	200	Concave Lens on Stem $f = -200$ mm	P-1003029	157
Capacitor 4.7 μF , 63 V, P2W19	P-1012946	206	Concave Mirror K	P-1009925	150...151
Capacitor 4.7 nF, 100 V, P2W19	P-1012951	206	Concave Mirror on Stem +75 mm	P-1003031	157
Capacitor 47 μF , 35 V, P2W19	P-1012958	206	Conducting Sphere, $d = 30$ mm, with 4 mm Plug	P-1001026	192
Capacitor 47 nF, 100 V, P2W19	P-1012944	206	Conducting Sphere, $d = 85$ mm, with 4 mm Plug	P-1000938	192
Capacitor 470 μF , 16 V, P2W19	P-1012960	206	Conductivity Electrode	P-1012889	213
Capacitor 470 pF, 160 V, P2W19	P-1012948	206	Conductivity Tester	P-1012890	213
Carbon Configurations, Set of 3	P-1012836	248	Conductors and Non-Conductors, Set of	P-1000948	197
Carbon Electrodes	P-1003508	212	Conductors for Biot-Savart Experiments, Set of 4	P-1018478	221
Cardboard Plate	P-1000936	195	Conductors in Magnetic Fields		222
Cartesian Diver	P-1002867	83	Connecting Cable for Electro Cardiograms	P-1020605	267...269
Cast Iron Bolts, Set of 10	P-1000827	130	Connecting Lead with Two Metal Rods	P-1017344	106
Castor Oil	P-1002671	139	Connection Cable MiniDIN8 – BT	P-1021688	48
Cathode Ray Tube	P-1000901	243	Constant Velocity Student Kit, 3 Tubes	P-1003502	34
Cavendish Torsion Balance	P-1003337	58	Constant Velocity Student Kit, 4 Tubes	P-1018624	34
CCD HD Sensor	P-1018820	168	Constantan Wire 0.4 mm / 50 m	P-1000957	196
CCD HD Sensor		168	Constantan Wire 0.2 mm / 100 m	P-1000955	196
Cell Holder on Stem	P-1002721	175	Constantan Wire 0.3 mm / 100 m	P-1000956	196
Centre of Gravity Plate	P-1008513	59	Constantan Wire 0.5 mm / 50 m	P-1000958	196
Centrifugal Pump	P-1002575	118	Contact Stand with Terminal Sockets	P-1000995	197
Change-Over Switch (SPDT) on 3B Box	P-1012694	198...199	Control Unit for Critical Potential Tubes		
Change-Over Switch, Double Pole, P4W50	P-1012991	208	(115 V, 50/60 Hz)	P-1000633	256...257
Chaotic Pendulum E	P-1017531	76	Control Unit for Critical Potential Tubes		
Charge and Discharge Apparatus			(230 V, 50/60 Hz)	P-1008506	256...257
(115 V, 50/60 Hz)	P-1017780	210	Control Unit for Spectrum Lamps		
Charge and Discharge Apparatus			(115 V, 50/60 Hz)	P-1003195	176
(230 V, 50/60 Hz)	P-1017781	210	Control Unit for Spectrum Lamps		
Charge Indicator	P-1009962	191	(230 V, 50/60 Hz)	P-1021409	176
Charge Sensor	P-1021684	44	Convex Concave Mirror, $f = \pm 100$ mm	P-1002985	146
Charge Spoon, Large	P-1002708	192	Convex Lens K, $f = 100$ mm	P-1010300	150...151
Charge Spoon, Small	P-1002707	192	Convex Lens K, $f = 150$ mm	P-1000871	150...151
Charge Storage Device with Piezo Charger	P-1009963	191	Convex Lens K, $f = 200$ mm	P-1009861	150...151
Charger and Discharger		210	Convex Lens K, $f = 300$ mm	P-1009866	150...151
Chladni Plate, Circular	P-1000705	101	Convex Lens K, $f = 50$ mm	P-1000869	150...151
Chladni Plate, Square	P-1000706	101	Convex Lens K, $f = 500$ mm	P-1009863	150...151
Chrome-Nickel Wire 0.5 mm / 50 m	P-1000954	196	Convex Lens N, $f = 100$ mm	P-1000842	152
Chrome-Nickel Wire 0.3 mm / 100 m	P-1000953	196	Convex Lens N, $f = 300$ mm	P-1000841	152
Clamp for Projectile Launcher	P-1002655	70	Convex Lens N, $f = 50$ mm	P-1000843	152
Clamp K	P-1008518	150...151	Convex Lens on Stem $f = +100$ mm	P-1003023	157
Clamp with Hook	P-1002828	297	Convex Lens on Stem $f = +150$ mm	P-1003024	157
Clamp with Jaw Clamp	P-1002829	297	Convex Lens on Stem $f = +200$ mm	P-1003025	157
Clamps D, Pair	P-1000977	230	Convex Lens on Stem $f = +300$ mm	P-1003026	157
Cloud Chamber	P-1000921	260	Convex Lens on Stem $f = +50$ mm	P-1003022	157
Coach 7, School Site License 5 years	P-1021522	37	Convex Mirror on Stem -75 mm	P-1003032	157
Coach 7, Single License 5 years	P-1021518	37	Copper Calorimeter	P-1002659	128
Coach 7, University Site License 5 years	P-1021524	37	Copper Plates, Set of 10	P-1002712	213
Coil D with 1200 Taps	P-1000989	228	Copper Sample for Hall Effect	P-1018751	266
Coil D with 600 Taps	P-1000988	228	Copper Shot, 200 g	P-1000833	303
Coil D with 6000 Taps	P-1000990	228	Copper Wire 0.3 mm / 100 m	P-1000949	196
Coil D, 900 Turns	P-1012859	229	Cord for Experiments	P-1001055	303
Coil on Acrylic Base	P-1000928	219	Cord, 100m	P-1007112	63, 303
Coil S with 1200 Taps	P-1001002	230	Cork Powder, 10 g Bottle	P-1000815	103
Coil S with 2400 Taps	P-1001003	230	Coulombmeter with Rechargeable Battery	P-1017734	31
Coil S with 600 Taps	P-1001000	230	Cr:YAG Module	P-1008637	184...187
Coil S with 800 Taps	P-1001001	230	Critical Point Apparatus	P-1002670	138
Coil Spring Slinky	P-1003516	99	Critical Potential Tube S with He-Filling	P-1000620	256...257
Coil with 600 Windings on 3B-Box	P-1011346	198...199	Critical Potential Tube S with Ne-Filling	P-1000621	256...257
Coil with Variable Number of Turns per Unit Length	P-1000965	220	Crocodile Clips 4mm, Not Insulated, Set 10	P-1019219	299
Coil, 10 mH, P2W19	P-1012983	207	Crocodile Clips on 3B Box	P-1010155	198...199
Collimator lens $f = +75$ mm	P-1008646	184...187	Crookes Radiometer	P-1002882	135
Colour		170	Cross Bosshead	P-1002831	297
Colour Filters, Primary Colours, Set of 3	P-1003185	165	Crosspiece DN 16 KF	P-1002924	93

Description	Art. No.	Page	Description	Art. No.	Page
Crown Glass Prism 60°, 27 mm x 50 mm	P-1002858	166	Digital Multimeter E	P-1018832	283
Crown Glass Prism 60°, 30 mm x 30 mm	P-1002864	166	Digital Multimeter P1035	P-1002781	282
Crown Glass Prism 60°, 45 mm x 50 mm	P-1002859	166	Digital Multimeter P3320	P-1002784	283
Crown Glass Prism 90°, 30 mm x 50 mm	P-1002860	166	Digital Multimeter P3340	P-1002785	282
Crown Glass Prism 90°, 45 mm x 50 mm	P-1002861	166	Digital Multimeter P3415	P-1008631	283
Crystallography Accessories	P-1000666	258b	Digital Oscilloscope 2x100 MHz	P-1020911	279
CT Controller	P-1017783	119	Digital Oscilloscope 2x30 MHz	P-1020910	279
CT Measuring Trough	P-1017785	119	Digital Oscilloscope 4x60 MHz	P-1008676	278
CT Sample	P-1017784	119	Digital oscilloscopes		278
CT Scanner	P-1017782	119	Digital Pocket Anemometer	P-1010250	122
Cubes for Determining Density, Set of 7	P-1000766	85	Digital Pocket Thermometer	P-1003335	126
Current Balance Equipment Set	P-1021822	222	Digital Quick Response Pocket Thermometer	P-1002803	125
Current Direction Indicator in 3B Box	P-1012697	198...199	Digital Spectrometer LD with Absorption Chamber	P-1019196	180...181
Current Sensor 5 A	P-1021678	44	Digital Stopwatch	P-1002811	51
Current Sensor 500 mA	P-1021679	44	Digital Thermometer, 1 Channel	P-1002793	127
Cuvette, Rectangular, 80x30x80 mm ³	P-1003534	302	Digital Thermometer, 2 Channels	P-1002794	127
Cyclic Processes		137	Digital Thermometer, Min/Max	P-1003010	126
Cyclic Processes		141	Digital-Spectrometer HD	P-1018104	180...181
Cylinders, Equal in Mass, Set of 3	P-1000754	84	Digital-Spectrometer LD	P-1018103	180...181
Cylinders, Equal in Volume, Set of 3	P-1000752	84	DIN-B Burette with Schellbach Stripe, 10 ml	P-1018065	193, 302
Cylinders, Set of 3	P-1002588	115	Diode D	P-1000646	234
Cylindrical Bar Magnet 200x10	P-1003112	214	Diode in 3B Box	P-1010157	198...199
Cylindrical Bar Magnet 50x20	P-1003556	214	Diode Laser 1000 mW	P-1009497	184...187
			Diode S	P-1000613	239
- D -			Displacement Sensor FW	P-1021534	42
Daniell Cell	P-1002898	212	DMM 1000 Iso-Multimeter	P-1012865	284
Darlington-Transistor TIP162, P4W50	P-1018847	208	DMM50 Digital Multimeter	P-1012817	284
DC Power Supply 0 – 16 V, 0 – 16 A	P-1002771	274	DMM60 Digital Multimeter	P-1012816	284
DC Power Supply 0 – 20 V, 0 – 5 A (115 V, 50/60 Hz)	P-1003311	274	Doppler Phantom Fluid	P-1002574	116
DC Power Supply 0 – 20 V, 0 – 5 A (230 V, 50/60 Hz)	P-1003312	274	Doppler Prisms and Flow Tubes, Set	P-1002572	117
DC Power Supply 0 – 300 V (230 V, 50/60 Hz)	P-1001012	275	Dosimeter Radex RD 1706	P-1012894	260
DC Power Supply 0 – 500 V (115 V, 50/60 Hz)	P-1003307	274	Double Slits on Glass Plate	P-1003204	164
DC Power Supply 0 – 500 V (230 V, 50/60 Hz)	P-1003308	274	Drilled Rod	P-1002710	298
DC Power Supply 1.5 – 15 V, 1.5 A (230 V, 50/60 Hz)	P-1003560	273	Drive Unit for Wave Machine (115 V, 50/60 Hz)	P-1021443	102
DC Power Supply 450 V (115 V, 50/60 Hz)	P-1008534	273	Drive Unit for Wave Machine (230 V, 50/60 Hz)	P-1021156	102
DC Power Supply 450 V (230 V, 50/60 Hz)	P-1008535	273	Drop and Launch Apparatus	P-1000588	68
DC Power Supply, 1 – 32 V, 0 – 20 A (230 V, 50/60 Hz)	P-1012857	274	Dry Fuel for Steam Engine B	P-1012886	137
Demo Multimeter	P-1017895	280	Dual Beam Tube S	P-1000622	240
Demonstration Gratings	P-1003082	162	Dual Channel Function Generator		
Demonstration Thermometer -10 – 110°C	P-1003014	124...125	40 mHz...20 MHz	P-1020913	277
Demonstration Tuning Fork	P-1000700	108	Dual-Beam Tube D	P-1000654	235
Demonstration Wave Machine, Complete Set	P-1003491	102	Dummy Flange DN 16 KF	P-1002927	93
Demonstration Wave Machine, Single Module	P-1003492	102	Dynamometer 1 kg / 10 N, Colour Coded	P-1003372	54
Demountable Transformer		228	Dynamometer 1 N, with Round Dial	P-1009738	54
Density		84	Dynamometer 10 N, with Round Dial	P-1009741	54
Density Bodies, Set of 5	P-1000768	83	Dynamometer 2 kg / 20 N, Colour Coded	P-1003373	54
Density Paradox Set	P-1003498	84	Dynamometer 2 N, with Round Dial	P-1009739	54
Device for Demonstrating the Anomaly of Water	P-1002889	132	Dynamometer 250 g / 2,5 N, Colour Coded	P-1003370	54
Diac, BR 100, P2W19	P-1012973	207	Dynamometer 3 kg / 30 N, Colour Coded	P-1003374	54
Diaphragm with 2 cross gratings	P-1000601	163	Dynamometer 5 kg / 50 N, Colour Coded	P-1003375	54
Diaphragm with 3 Circular Holes and Disc Pairs	P-1000603	163	Dynamometer 5 N, with Round Dial	P-1009740	54
Diaphragm with 3 Double Slits of Different Widths	P-1000596	163	Dynamometer 500 g / 5 N, Colour Coded	P-1003371	54
Diaphragm with 3 ruled gratings	P-1000599	163	Dynamometers		54
Diaphragm with 3 Single Slits and 1 Double Slit	P-1000885	162	Dynamometers for Demonstrating Hooke's Law	P-1003109	55
Diaphragm with 4 Double Slits of Different Spacings	P-1000597	163			
Diaphragm with 4 Multiple Slits and Gratings	P-1000598	163	- E -		
Diaphragm with 9 Circular Discs	P-1000889	163	E 10 Lamp Socket, Sideways Facing, P2W19	P-1012986	209
Diaphragm with 9 Circular Holes	P-1000891	163	E 10 Lamp Socket, Upwards Facing, P2W19	P-1012987	209
Diaphragm with a Single Slit and Rib	P-1000602	162	E10 Lamp Socket on 3B Box	P-1010138	198...199
Diffraction Apertures on Glass Plate	P-1008664	164	E14 Lamp Socket on Stem	P-1000853	156
Diffraction Elements		162	E27 Lamp Socket on Stem	P-1000854	156
Diffraction Gratings on Glass Plate	P-1014621	164	Ecoflam Pellets, Set of 60	P-1010255	289
Diffraction Tube S	P-1013889	240	Elastic Deformation		89
Digital Callipers, 150 mm	P-1002602	52	Electric Doorbell	P-1003170	91
Digital Camera for Microscopes, 2 Mpixel	P-1021376	293	Electric Field Meter (115 V, 50/60 Hz)	P-1021406	194
Digital Camera HUE HD Pro	P-1021167	293	Electric Field Meter (230 V, 50/60 Hz)	P-1021405	194
Digital Camera Moticom2	P-1021164	292	Electric Motor and Generator, Complete	P-1017801	224
Digital Counter (115 V, 50/60 Hz)	P-1001032	51, 259	Electrical Burner LAB2 (230 V, 50 Hz)	P-1010252	289
Digital Counter (230 V, 50/60 Hz)	P-1001033	51, 259	Electrical Circuits		196
Digital Counters		286	Electricity and Magnetism		190
Digital Energy Meter	P-1002802	285	Electro-Chemistry		211
Digital Hygro-Thermometer	P-1003011	122	Electrochemistry Case	P-1002719	211
Digital Luxmeter	P-1002779	285	Electrochemistry, Equipment Set for	P-1002711	213
Digital Mini Multimeter	P-1002783	282	Electrodes for ECG/EMG, Set of 30	P-5006578	269
			Electrolytic Trough	P-1009884	193
			Electromagnet Accessory for Zeeman Effect	P-1021365	252...253
			Electromagnetism, Equipment Set	P-1002661	223



Description	Art. No.	Page	Description	Art. No.	Page
Electrometer (115 V, 50/60 Hz)	P-1001024	192	Free Electrons in Gases and in Vacuum		231
Electrometer (230 V, 50/60 Hz)	P-1001025	192	Free Fall		69
Electrometer Accessories	P-1006813	192	Free Fall Apparatus	P-1000738	69
Electron Deflection Tube D	P-1000651	232	Free Fall Tube	P-1000801	69
Electron Diffraction Tube D	P-1013885	232	Free Standing Cylinder, without Graduation	P-1002871	302
Electronic Scale 200 g	P-1003433	295	Frequency Doubling Module	P-1008636	184...187
Electronic Scale 5000 g	P-1003434	295	Fresnel Biprism	P-1008652	167
Electronic Scale Scout SKX 420 g	P-1020859	295	Fresnel Mirror		160
Electronic Scale Scout SKX 620 g	P-1020860	295	Fresnel Mirror Experiment Set	P-1003059	160
Electroscope	P-1003048	191	Fresnel Mirror K	P-1009927	150...151
Electroscope S	P-1009964	191	Fresnel Mirror on Stem	P-1002649	160
Electrostatic Equipment Set	P-1021369	190	Friction		60
Electrostatics		190	Friction Measuring Apparatus	P-1009942	60
ELV Motor on 3B Box	P-1010158	198...199	Friction Rods	P-1002709	192
Energy and the Environment		120	Fuel Cell Accessories	P-1021790	36
Equipment Set "Sound Propagation in Rods" (115 V, 50/60 Hz)	P-1018468	107	Fuel Cell Demonstration System	P-1002689	36, 121
Equipment Set "Sound Propagation in Rods" (230 V, 50/60 Hz)	P-1018469	107	Fuel cells		121
Equipment Set "Stereophonic Hearing"	P-1018551	107	Function Generator 10 mHz...3 MHz	P-1020912	277
Equipment Sets		188	Function Generator FG 100 (115 V, 50/60 Hz)	P-1009956	276
Equivalent of Heat		128	Function Generator FG 100 (230 V, 50/60 Hz)	P-1009957	276
ESR Supplementary Set	P-1000640	262...263	Function Generator SG 10 (115 V, 50/60 Hz)	P-1017338	276
ESR/NMR		262	Function Generator SG 10 (230 V, 50/60 Hz)	P-1017337	276
ESR/NMR Basic Set (115 V, 50/60 Hz)	P-1000637	262...263	Function Generators		276
ESR/NMR Basic Set (230 V, 50/60 Hz)	P-1000638	262...263	Fundamentals of Atomic Physics		250
Exp.: Simple Electric Circuit	P-1013825	198...199	Funhouse Mirror 60x130 cm ²	P-1003339	172
Experiment Lead, Plug and Socket	P-1002838	299	Fuse Holder on 3B Box	P-1010154	198...199
Experiment Lead, Safety Plug and Socket	P-1002839	299	Fuses, Set of	P-1012873	300
Experiment Leads and Cables		299	Fusion Ring	P-1000980	229
Experiment Leads for Electron Tube Experiments, Set of	P-1002847	299	- G -		
Experiment Leads, 75 cm, 1 mm ² , Set of 15	P-1002840	299	Galvanometer, DC	P-1002790	280
Experiment Leads, 75 cm, 2.5 mm ² , Set of 15	P-1002841	299	Gas Discharge Tube	P-1002905	242
Experiment Leads, 75 cm, Pair	P-1002850	299	Gas Discharge Tube S	P-1000624	242
Experiment Motor with Gearbox	P-1021806	73, 227	Gas Expansion Apparatus	P-1003511	132
Experimental Lamp, Halogen	P-1003038	155	Gas Filled Photocell	P-1000916	251
Extension Arm D	P-1002646	155	Gas Laws		138
Extension Cable (Analog) BT-BT	P-1021500	49	Gas Triode D	P-1000653	234
External Centring Ring DN 10/16 KF	P-1002931	93	Gas Triode S with He-Filling	P-1000618	239
External Micrometer	P-1002600	52	Gas Triode S with Ne-Filling	P-1000619	239
Extra Pulley	P-1000699	59	Gauge with Adapter	P-1012862	131
- F -			Gay-Lussac Pycnometer	P-1002874	84
Fabry-Pérot Etalon	P-1020903	252...253	Geared Motor with Pulley	P-1017735	31
Falling Sphere Viscometer	P-1012827	88	Geiger Counter	P-1002722	29, 259
Faraday Cup	P-1000972	192	Geiger-Müller Counter Tube	P-1001035	259
Faraday Effect		173	Geiger-Müller Tube T	P-1000661	258c
Field Coil 100 mm	P-1000591	220	Geometric Optics		149
Field Coil 120 mm	P-1000592	220	Geometrical Objects		161
Film-pack 2	P-1000669	258h	Geometrical Objects on Glass Plate	P-1014622	161
Film-pack 4	P-1000670	258h	Germanium Diode, AA 118, P2W19	P-1012963	207
Filter BG40	P-1017874	184...187	Glass Cylinder with 2 Tubes	P-1002891	87
Filter RG850	P-1008648	184...187	Glass Inset for Newton's Rings Experiments	P-1008669	160
Filters		165	Glass Shot, 100 g	P-1000834	303
Fine Beam Tube on Connection Base R	P-1019957	244	Glassware		302
Fine Beam Tube T	P-1008505	245	Globe with Bar Magnet	P-1013123	216
Five-Beam Lamp	P-1003187	149	Glycerine, 250 ml	P-1007027	88, 303
Flame Probe for Electric Field Meter	P-1021799	194	Graduated Cylinder, 100 ml	P-1002870	302
Flat Coil in a Rotatable Frame	P-1013131	225	Graduated Cylinder, 250 ml	P-1010114	302
Flat Coils, Pair	P-1000942	218	Graetz Bridge in 3B Box	P-1012695	198...199
Flexible Magnetic Field Sensor	P-1012892	288	Grating 1000/mm	P-1003181	163
Flint Glass Block for Faraday Effect	P-1012860	173	Grating 140/mm	P-1003178	163
Flint Glass Prism 60°, 30 mm x 30 mm	P-1002865	166	Grating 530/mm	P-1003179	163
Fluorescence of Sodium		258	Grating 600/mm	P-1003180	163
Fluorescence Samples, Set	P-1012868	258h	Gratings, Set of 4	P-1003081	163
Force Plate	P-1021677	43	Gravitation / Astronomy		58
Force Sensor	P-1021676	43	Green LED on 3B Box	P-1010191	198...199
Force Table	P-1000694	59	Greenhouse Effect		121
Foucault Pendulum (115 V, 50/60 Hz)	P-1000747	80	Gyroscope	P-1000695	74
Foucault Pendulum (230 V, 50/60 Hz)	P-1000748	80	Gyroscope		74
Franck-Hertz Tube with Hg	P-1003549	254...255	Gyroscope Accessories	P-1000698	74
Franck-Hertz Tube with Mercury Filling and Heating Chamber (115 V, 50/60 Hz)	P-1006794	254...255	Gyroscope S	P-1013228	74
Franck-Hertz Tube with Mercury Filling and Heating Chamber (230 V, 50/60 Hz)	P-1006795	254...255	- H -		
Franck-Hertz Tube with Ne	P-4008614	254...255	Hall Effect		264
Franck-Hertz Tube with Ne Filling on Base	P-1000912	254...255	Hall Effect Basic Apparatus	P-1009934	264...265
Franck-Hertz-Experiment		254	Halogen Lamp 12 V, 20 W	P-1003533	150...151
			Halogen Lamp 500 W (230 V, 50/60 Hz)	P-1000894	120
			Halogen Lamp, 12 V, 35 W	P-1003324	147
			Halogen Lamp, 12 V, 55 W	P-1003322	146
			Hand Spectroscope with Amici Prism	P-1003531	178

Description	Art. No.	Page	Description	Art. No.	Page
Hand-Held Analogue Measuring Instruments		280	Holder K for Diode Laser	P-1000868	150...151
Hand-Held Digital Measuring Instruments		282	Holder on Stem for Direct-Vision Prism	P-1012863	158
Hand-Held Refractometer HRT32	P-1021440	290	Holder on Stem for Lenses without Frame	P-1003164	159
Hand-Held Refractometer HRT62	P-1021441	290	Hole Diaphragms, Set of 5	P-1000848	161
Hand-Held Refractometer HR901	P-1021249	290	Hollow Prism, Equal-Sided	P-1014618	166
Heart Model	P-1002590	115	Hologram	P-1003177	162
Heat		124	Hook Weights and Thread, Set of	P-1019180	65
Heat Conducting Rod Al	P-1017331	136	Horn Loudspeaker	P-1000811	111
Heat Conducting Rod Cu	P-1017330	136	Horseshoe Magnet 130 mm, with Yoke	P-1003114	214
Heat Conduction		136	Horseshoe Magnet 140 mm, with Yoke	P-1003088	214
Heat Conduction Equipment Set	P-1017329	136	Horseshoe Magnet, 70 mm	P-1000929	214
Heat Conductivity Device	P-1003383	133	Humidity Sensor	P-1021510	46
Heat Equivalent Apparatus	P-1002658	128	Hydraulic/Pneumatic Lifting Platform	P-1003495	86
Heat Flow		133	Hysteresis Curve, Equipment Kit	P-1018889	215
Heat Flow Device	P-1002903	133			
Heat Flow Device S	P-1003512	133	- I -		
Heat Pump D (115 V, 50/60 Hz)	P-1000819	144	Ice Bomb	P-1000828	130
Heat Pump D (230 V, 50/60 Hz)	P-1000820	144	Image Objects, Set of 4	P-1000886	161
Heat Sources		289	Immersion Block Al 100 cm ³	P-1002953	84
Heating Chamber (115 V, 50/60 Hz)	P-1006796	258	Immersion Block Al 50 cm ³	P-1002952	84
Heating Chamber (230 V, 50/60 Hz)	P-1012820	258	Immersion Block Fe 100 cm ³	P-1002955	84
Heating rod K	P-1017340	104...105	Immersion Block Fe 50 cm ³	P-1002954	84
Helical Spring Snakey	P-1008687	99	Immersion Heater (230 V, 50/60 Hz)	P-1003566	289
Helical Springs		55	Immersion Heater, 12V	P-1003258	129
Helical Springs 1,5 N/m	P-1000786	55	Immersion/Circulation Thermostat		
Helical Springs 16 N/m	P-1002702	55	(115 V, 50/60 Hz)	P-1008653	139
Helical Springs 2.5 N/m	P-1003515	55	Immersion/Circulation Thermostat		
Helical Springs 20 N/m, 180 mm	P-1002946	55	(230 V, 50/60 Hz)	P-1008654	139
Helical Springs 3.0 N/m	P-1002945	55	Inclination Instrument	P-1003192	217
Helical Springs 43 N/m	P-1002703	55	Inclination Instrument E	P-1006799	217
Helical Springs 5 N/m	P-1000741	55	Inclined Plane	P-1003213	62
Helical Springs 86 N/m	P-1002704	55	Inductance Decades	P-1013905	204
Helical Springs for Hooke's Law, Set of	P-1003376	55	Induction		224
Helmholtz Coils 300 mm	P-1000906	225	Induction Apparatus	P-1000968	224
Helmholtz Coils on Mounting Plate, Pair of	P-1003193	220	Induction Coils, Set of 3	P-1000590	226
Helmholtz Pair of Coils D	P-1000644	236	Inertia Balance	P-1003235	77
Helmholtz Pair of Coils S	P-1000611	241	Infra-Red Temperature and Humidity Gauge	P-1002795	122
Helmholtz Resonator d = 32 mm	P-1003523	110	Infra-red Thermometer, 380° C D	P-1020909	127
Helmholtz Resonator d = 40 mm	P-1003522	110	Infra-Red Thermometer, 800° C	P-1002791	127
Helmholtz Resonator d = 52 mm	P-1003521	110	Inkjet Pucks Basic Set	P-1021624	67
Helmholtz Resonator d = 70 mm	P-1003520	110	Insertion Thermometer	P-1003334	126
He-Ne Laser	P-1003165	156	Insertion Thermometer F	P-1010219	126
Hexagonal Magnet Model	P-1002975	218	Instrumentation		270
HF Coil, 33 mH, P2W19	P-1012984	207	Insulator with Clamp	P-1002970	197
HF Patch Cord	P-1002746	301	Interference Filter 436 nm	P-1008671	165
HF Patch Cord, BNC/4 mm Plug	P-1002748	301	Interference Filter 546 nm	P-1008670	165
Hg High-Pressure Spare Lamp (230 V, 50/60 Hz)	P-1003161	177	Interference Filter 578 nm	P-1008672	165
Hg High-Pressure Spectral Lamp			Interferometer	P-1002651	183
(230 V, 50/60 Hz)	P-1003157	177	Inverting Spectacles	P-1000895	167
Hg Low-Pressure Spare Lamp (230 V, 50/60 Hz)	P-1003162	177	Ionisation Chamber	P-1000668	258h
Hg Low-Pressure Spectral Lamp			IR Detector Card	P-1017879	184
(230 V, 50/60 Hz)	P-1003158	177	Iris Diaphragm K	P-1000850	150...151
High Current Coil D for Nail Fusing Experiment	P-1000984	228	Iris on Stem	P-1003017	159
High Current Coil S	P-1000999	230	Iron Filings	P-1000580	218
High Current Coil with Five Turns	P-1000981	229	Iron Plates, Set of 10	P-1002714	213
High Current Sensor, 10 A	P-1000545	45	Iron Wire 0.3 mm/ 100 m	P-1000950	196
High Voltage Coil D Including 2 Horn Shaped Electrodes	P-1000991	228			
High Voltage Power Supply 5 kV (115 V, 50/60 Hz)	P-1003309	274	- J -		
High Voltage Power Supply 5 kV (230 V, 50/60 Hz)	P-1003310	274	Jet Nozzle (Flow Laminator)	P-1000758	94
High-Pressure Mercury Vapour Lamp	P-1000852	177, 251	Jolly's Bulb and Gauge	P-1012870	140
High-Voltage Cables, 150 cm, Pair	P-1002851	300	Jumpers, P2W19, Set of 10	P-1012985	209
High-Voltage Power Supply 10 kV (115 V, 50/60 Hz)	P-1020138	275			
High-Voltage Power Supply 10 kV (230 V, 50/60 Hz)	P-1019234	275	- K -		
High-Voltage Power Supply E 5 kV (115 V, 50/60 Hz)	P-1017725	275	Kater's Reversible Pendulum	P-1018466	77
High-Voltage Power Supply E 5 kV (230 V, 50/60 Hz)	P-1013412	275	Kirchhoff-Bunsen Spectroscope	P-1002911	179
Hofmann's Voltmeter S	P-1003507	212	Kit Greenhouse Effect (115 V, 50/60 Hz)	P-1009764	121
Hofmann's Voltmeter	P-1002899	212	Kit Greenhouse Effect (230 V, 50/60 Hz)	P-1000837	121
Holder and Filter for Moticam	P-1021367	252...253	Knife-Edge Switch on 3B Box	P-1010152	198...199
Holder for Components	P-1008524	196	Kolbe's Electroscop	P-1001027	191
Holder for Light Barrier	P-1018448	69, 298	Kröncke Optical System for Student Exercises		32
Holder for Magnetic Field Sensor	P-1019212	221	Kröncke Optics		150
Holder for Plug-in Components	P-1018449	298	K-Type NiCr-Ni Immersion Sensor, -200°C – 1150°C	P-1002805	124
			K-Type NiCr-Ni Immersion Sensor, -65°C – 550°C	P-1002804	124
			Kundt's Tube	P-1000814	103
			Kundt's Tube E	P-1017339	104...105
			- L -		
			Lab Material		296



Description	Art. No.	Page	Description	Art. No.	Page
Labinterfaces		40	Magnetic Holder for Single-Ray Projector	P-1003323	147
Laboratory Jack I	P-1002943	296	Magnetic Needle, 80 mm	P-1000674	217
Laboratory Jack II	P-1002941	296	Magnetic Stirrer	P-1002808	289
Laboratory Jack III	P-1002942	296	Magnetic Stirrer 12L (230 V, 50/60 Hz)	P-1011739	289
Laboratory Scales		294	Magnetic Stirrer with Heater (115 V, 50/60 Hz)	P-1002806	289
Laminar Flow		95	Magnetic Stirrer with Heater (230 V, 50/60 Hz)	P-1002807	289
Laminar Flow Apparatus	P-1006784	95	Magnetic Stirrers		289
Lamp Housing on a Stand Rod	P-1003197	176	Magnetising Coil	P-1003237	220
Lamp Socket E10 on Acrylic Base	P-1000946	196	Magnetism		214
Lamp Socket E14 on Acrylic Base	P-1000947	196	Mains Coil D with Connecting Lead (115 V, 50/60 Hz)	P-1000986	228
Lamp Sockets E10, Set of 10	P-1010137	197	Mains Coil D with Connecting Lead (230 V, 50/60 Hz)	P-1000987	228
Laser Communication, Equipment Set	P-1003055	189	Maltese Cross Tube D	P-1000649	233
Laser Diode Driver and Temperature Controller	P-1008632	184...187	Maltese Cross Tube S	P-1000011	238
Laser Diode for Debye-Sears Effect, Green	P-1002579	112	Marble in a Bowl	P-1017332	68
Laser Diode for Debye-Sears Effect, Red	P-1002577	112	Mariotte Flask	P-1002894	140
Laser Diode, Red	P-1003201	156	Maxwell's Wheel	P-1000790	69
Laser Mirror	P-1008638	184...187	Measurement Amplifier U (115 V, 50/60 Hz)	P-1020744	266, 287
Laser Mirror HAT, 532 nm	P-1008639	184...187	Measurement Amplifier U (230 V, 50/60 Hz)	P-1020742	266, 287
Laser Module, Green	P-1003202	156	Measurement Chamber for Earthworm Experiments	P-1020601	267...269
Laser Range Finder	P-1020907	53	Measurement of Length		52
Laser Ray Box (115, 50/60 Hz)	P-1003051	148	Measurement of Time		51
Laser Ray Box (230 V, 50/60Hz)	P-1003052	148	Measurement of Volume		53
Laser Reflection Sensor	P-1001034	51, 286	Measuring Amplifier S	P-1001028	287
Laser Safety Goggles for Nd:YAG Laser	P-1002866	184	Mechanical Balance 311	P-1003421	294
Launch Apparatus, Electromagnetic	P-1019300	65	Mechanical Balance 610	P-1003419	294
Launcher S	P-1000740	71	Mechanical Cumulative Stopwatch	P-1002810	51
Leclanché Cell	P-1002897	213	Mechanical Stopwatch, 15 min	P-1003369	51
LED Graetz Bridge in 3B Box	P-1012696	198...199	Mechanical Stopwatch, 30 min	P-1003368	51
LED Infra-Red, Sideways Facing, P2W19	P-1018839	207	Mechanical Waves		99
LED, Green, Upward Facing, P2W19	P-1012971	207	Mechanics		50
LED, Red, Sideways Facing, P2W19	P-1012972	207	Mechanics Kit for Whiteboard	P-1000735	51
LED, Red, Upward Facing, P2W19	P-1012962	207	Metal Ring	P-1000992	229
LED, Yellow, Upward Facing, P2W19	P-1018837	207	Metal Strips, Set of 5	P-1000982	229
Lenz's Law Copper Tube	P-1009716	227	Metallophone	P-1000804	110
Lenz's Law Apparatus	P-1009959	227	Michelson Interferometer		183
Leslie Cube with Heater (115 V, 50/60Hz)	P-1017729	135	Micrometer Screw K	P-1000887	150...151
Leslie Cube with Heater (230 V, 50/60Hz)	P-1017730	135	Micromotor, 1.5 V DC, P2W19	P-1012995	207
Leslie's Cube	P-1000835	134	Microphone probe, long	P-1017342	104...105
Lever	P-1008539	62	Microphone probe, short	P-4008308	104...105
Light and Optics		146	Microscopes		291
Light Box P	P-1018471	35	Microsecond counter (115 V, 50/60 Hz)	P-1017334	106
Light Emitting Diodes for Determination of h	P-1000917	250	Microsecond Counter (230 V, 50/60 Hz)	P-1017333	106
Light Metal Tuning Fork, 1000 Hz	P-1002608	108	Microstructures on Glass Plate	P-1014620	164
Light Metal Tuning Fork, 1700 Hz	P-1002607	108	Microwave Set 10.5 GHz (115 V, 50/60 Hz)	P-1009950	96...97
Light Sensor	P-1021503	48	Microwave Set 9.4 GHz (230 V, 50/60 Hz)	P-1009951	96...97
Light Sensor, Three Ranges	P-1021502	48	Millikan's Apparatus (115 V, 50/60 Hz)	P-1018882	247
Linear Expansion Apparatus D	P-1002977	131	Millikan's Apparatus (230 V, 50/60 Hz)	P-1018884	247
Linear Expansion Apparatus S	P-1002978	131	Millikan's Experiment		247
Linear Expansion Apparatus with Three Pointers	P-1000830	131	Millikan's Oil Drop Experiment		247
Linear Motion		63	Millisecond Counter (115 V, 50/60 Hz)	P-1012833	286
Lip Whistle	P-1009924	110	Millisecond Counter (230 V, 50/60 Hz)	P-1012832	286
Lodestone	P-1003091	215	Mirror Foil		172
Loop-Shaped Conductor on Acrylic Base	P-1000927	219	Model Crystals		248
Lorentz Force Apparatus	P-1003251	222	Model Eye for Ultrasonic Biometry	P-1012869	116
Lorentz Motor	P-1002662	223	Model of Overhead Power Lines, Pair	P-1021347	202
Low Temperature Stirling Engine Assembly Kit	P-1002599	143	Molecule Building Sets		248
Low Voltage Coil D	P-1000985	228	Moll-Type Thermopile	P-1000824	134
Low-Frequency Transformer, 1:2, P4W50	P-1012982	208	Momentary Contact Switch on Acrylic Base	P-1000962	196
Low-Temperature Stirling Engine	P-1002598	143	Monochord	P-1000806	110
Luminescence Tube D	P-1000648	233	Monochord D	P-1002959	110
Luminescence Tube S	P-1000615	238	Monochord Strings, Set of 3	P-1002960	110
- M -			Monocular Course Microscope M100 LED	P-1005406	291
Mach-Zehnder Interferometer		182	Moticam 1	P-1021162	247, 292
Mach-Zehnder-Interferometer	P-1014617	182	Moticam Adapter Ring	P-1021536	247
Magdeburg Hemispheres	P-1003208	90	Motion Detector	P-1021683	42
Magdeburg Plates	P-1003496	90	Motion Detector eMotion	P-1021673	41
Magnet Model, Cubic	P-1002976	218	Motion in a Plane		66
Magnetic Equipment Set	P-1003089	214	Motor Drive Debye-Scherrer (230 V, 50/60 Hz)	P-1019216	258b
Magnetic Field Indicator	P-1003555	216	Motor with Drive Control	P-1002705	170
Magnetic field line apparatus, Two-Dimensional	P-1003092	218	Motor, 12 V DC	P-1001041	101
Magnetic Field Lines Device, Three-Dimensional	P-1009765	218	Multiple Ray Projector, Magnetic	P-1003321	146
Magnetic Field Sensor	P-1021685	45	Multiple Slits on Glass Plate	P-1008666	164
Magnetic Field Sensor FW ± 200 mT	P-1021798	45			
Magnetic Field Sensor FW ± 2000 mT	P-1021766	45	- N -		
Magnetic Field Sensor, Axial/Tangential	P-1001040	288	Na Low-Pressure Spare Lamp (230 V, 50/60 Hz)	P-1003163	177
Magnetic Fields		216	Na Low-Pressure Spectral Lamp		
Magnetic Fields		288			
Magnetic Fields, Set of Apparatus for Displaying	P-1000925	219			

Description	Art. No.	Page	Description	Art. No.	Page
(230 V, 50/60 Hz)	P-1003159	177	– P –		
Nal Operating and Evaluation Unit	P-1008708	261	Paraffin Prism	P-4008112	97
Nal(Tl) Scintillation Detector	P-1008707	261	Parallel Light Optical Lamp N (230 V, 50/60 Hz)	P-1006791	152
Nails for Nail Fusing Experiment, Set of 20	P-1000983	229	Pascal's Pressure Sphere	P-1002892	86
Nd:YAG Module	P-1008635	184...187	Pascal's Vane Apparatus	P-1002957	86
N-Doped Germanium on Printed Circuit Board	P-1009760	264...265	PC Oscilloscope, 2x25 MHz	P-1020857	278
Neurophysiology		267	P-Doped Germanium on Printed Circuit Board	P-1009810	264...265
NEVA Optical System		152	Peltier Heat Pump	P-1020769	145
Newton's Colour Disc	P-1002983	170	Pendulum Bobs, Set of 4	P-1003230	75
Newton's Colour Disc, with Crank	P-1010194	170	Pendulum Rod	P-1000764	75
Newton's Colour Disc, with DC Motor	P-1010175	170	Pendulum Rod with Angle Sensor (115 V, 50/60 Hz)	P-1000762	75
Newton's Rings		160	Pendulum Rod with Angle Sensor (230 V, 50/60 Hz)	P-1000763	75
Nickel Plates, Set of 5	P-1002715	213	Periodic Table of the Elements		246
Nickel Wire 0.3 mm / 50 m	P-1000951	196	Periodic Table of the Elements, with Electron Configurations	P-1017655	246
NMR Supplementary Set	P-1000642	262...263	Periodic Table of the Elements, with Pictures	P-1013907	246
Noise		123	Permanent Magnet with Adjustable Pole Spacing	P-1002660	223
Noise Level Indicator SPL	P-1012741	123	Perrin Tube D	P-1000650	233
Noise Level Meter P8005	P-1002780	285	Perrin Tube S	P-1000616	238
NTC Resistor, 2.2 kΩ, P2W19	P-1012941	207	Photo Gate	P-1000563	42, 51
NTC Thermistor Probe, 4.7 kΩ	P-1021413	203	Photo Gate Holder for Projectile Launcher	P-1002657	71
– O –			Photogate Holder for Pendulum	P-1000756	76
Object for Measurement Exercises	P-1006889	53	Photoresistor, LDR 05, P2W19	P-1012940	207
Object Holder N	P-1000845	152	Phototransistor BPX43, P2W19	P-1018842	207
Object Holder on Stem	P-1000855	158	Physical Eye Model	P-1003806	35
Objective for Beam Divergence	P-1000675	156	Physics on a Small Budget		68
Oersted's Needle Device	P-1009710	215	Picket Fence	P-1000564	42
Ohm's Law Apparatus in 3B Box	P-1012698	198...199	Piezoelectric Charge Source	P-1000923	191
Oil for Millikan's Apparatus	P-1019304	247	PIN Photodiode DET 10 A/M	P-1008641	184...187
Oil for Steam Engine	P-1012887	137	PIN Photodiode DET 36 A/M	P-1008640	184...187
Operating Unit for Fine-Beam Tube	P-1009948	245	Pirani Vacuum Gauge (230 V, 50/60 Hz)	P-1012514	93
Operational Amplifier, LM 741, P4W50	P-1012981	208	Piston Vacuum Pump	P-1000798	92
Optical Base D	P-1009733	155	Planck's Constant Apparatus (115 V, 50/60 Hz)	P-1000536	250
Optical Bench K, 1000 mm	P-1009696	150...151	Planck's Constant Apparatus (230 V, 50/60 Hz)	P-1000537	250
Optical Bench K, 2000 mm	P-1009699	150...151	Plane Mirror	P-1002984	146
Optical Bench K, 500 mm	P-1009926	150...151	Plane Mirror	P-1003190	302
Optical Bench KL	P-1008642	184...187	Plane Mirror K	P-1003532	150...151
Optical Bench N	P-4003987	152	Plane Mirror on Stem	P-1003033	157
Optical Bench U, 1200 mm	P-1003039	153	Plane Parallel Plate	P-1002988	146
Optical Bench U, 600 mm	P-1003040	153	Plano Concave Lens, f = -400 mm	P-1002986	146
Optical Components on Stem		157	Plano Convex Lens, f = +400 mm	P-1002987	146
Optical Components, Set	P-1002993	149	Plastic Trough	P-4000036	132, 302
Optical Crystals		166	Plate Capacitor D	P-1006798	195
Optical Disc with Accessories	P-1003036	153	Plate Capacitor S	P-1003232	195
Optical Disc with Diode Laser (115 V, 50/60 Hz)	P-1003057	149	Plug In Power Supply 24 V, 0.7 A (115V, 50/60 Hz)	P-1000680	81, 270
Optical Disc with Diode Laser (230 V, 50/60 Hz)	P-1003058	149	Plug In Power Supply 24 V, 0.7 A (230 V, 50/60 Hz)	P-1000681	81, 270
Optical Equivalent to Debye-Scherrer Interference	P-1000656	236	Plug-In Board for Components	P-1012902	206
Optical Lamp K	P-1000863	150...151	Plug-In Power Supply 3 V DC (100-240 V, 50/60 Hz)	P-1008659	160
Optical Lamp N (230 V, 50/60 Hz)	P-1009946	152	Plug-In Power Supply, 12 V AC, 2000 mA (115 V, 50/60 Hz)	P-1012899	270
Optical Lamp with Pinhole Aperture	P-1017284	182	Plug-In Power Supply, 12 V AC, 2000 mA (230 V, 50/60 Hz)	P-1012900	270
Optical Lamps on Stem		155	Plug-In Power Supply, 12 V AC, 500 mA (115 V, 50/60 Hz)	P-1009545	270
Optical LED Lamp	P-1020630	155	Plug-In Power Supply, 12 V AC, 700 mA (230 V, 50/60 Hz)	P-1001014	270
Optical Precision Bench D, 100 cm	P-1002628	154	Plumb with Line	P-1002940	59
Optical Precision Bench D, 200 cm	P-1002629	154	Pneumatic Lighter	P-1003569	140
Optical Precision Bench D, 50 cm	P-1002630	154	Pockels Cell on Stem	P-1013393	174
Optical Rider D, 120/50	P-1002637	154	Pockels Effect		174
Optical Rider D, 60/36	P-1002639	154	Pocket Measuring Tape, 2 m	P-1002603	52
Optical Rider D, 60/50	P-1012400	154	Pocket Spectroscope	P-1003078	178
Optical Rider D, 90/36	P-1012401	154	Pocket Thermometer -10 – 110°C	P-1002881	124...125
Optical Rider D, 90/50	P-1002635	154	Pohl's Torsion Pendulum	P-1002956	81
Optical Rider K	P-1000862	150...151	Polarimeter	P-1008696	175
Optical Rider U, 35 mm	P-1003042	153	Polarimeter Tube 100 mm	P-1012883	175
Optical Rider U, 75 mm	P-1003041	153	Polarimeter Tube 200 mm	P-1012884	175
Optical Telecommunications Equipment Set	P-1008674	188	Polarimeter with 4 LEDs (230 V, 50/60 Hz)	P-1001057	174
Optics Kit for Whiteboard	P-1000604	146	Polarisation		175
Optics on a Whiteboard		146	Polarisation Filter on Stem	P-1008668	158
Optics Using an Optical Bench D		154	Polarisation Filters K, Pair	P-1009929	150...151
Optics Using an Optical Bench U		153	Polarising Attachment	P-1021364	252...253
Optics with Laser Ray Box, Equipment Set	P-1003049	148	Pole Shoe Fitting D	P-1008525	230
Orbit™ Tellurium	P-1008661	58	Pole Shoes and Clamping Brackets for		
Organic Molecule Set D	P-1005278	249			
Organic Molecule Set S	P-1005290	248			
Organic/Inorganic Molecule Set D	P-1005279	248			
Organic/Inorganic Molecule Set S	P-1005291	249			
Oscillation Tube	P-1002895	140			
Oscillations		75			
Outlet Vessel, Metal	P-1009715	87			



Description	Art. No.	Page
Hall Effect, Pair	P-1009935	230
Pole Shoes D, Pair	P-1000978	230
Polyoxymethylene Test Block with Protractor Scale	P-1002586	114
Potentiometer 1 k Ω , 1 W, P4W50	P-1012936	208
Potentiometer 10 k Ω , 1 W, P4W50	P-1012937	208
Potentiometer 100 k Ω , 1 W, P4W50	P-1012939	208
Potentiometer 220 Ω , 3 W, P4W50	P-1012934	208
Potentiometer 4.7 k Ω , 1 W, P4W50	P-1012938	208
Potentiometer 470 Ω , 1 W, P4W50	P-1012935	208
Power Supplies		270
Power Supply Unit for Franck-Hertz Experiment (115 V, 50/60 Hz)	P-1012818	254...255
Power Supply Unit for Franck-Hertz Experiment (230 V, 50/60 Hz)	P-1012819	254...255
Precision Dynamometer 0.1 N	P-1003102	54
Precision Dynamometer 0.2 N	P-1003103	54
Precision Dynamometer 1 N	P-1003104	54, 60
Precision Dynamometer 10 N	P-1003107	54, 60
Precision Dynamometer 100 N	P-1003110	54
Precision Dynamometer 2 N	P-1003105	54, 60
Precision Dynamometer 20 N	P-1003108	54
Precision Dynamometer 5 N	P-1003106	54
Precision Hair Hygrometer	P-1002877	122
Precision Resistor 1 k Ω	P-1009887	200
Precision Resistor 1 M Ω	P-1000687	200
Precision Resistor 1 Ω	P-1009843	200
Precision Resistor 10 k Ω	P-1000685	200
Precision Resistor 10 M Ω	P-1000688	200
Precision Resistor 10 Ω	P-1009844	200
Precision Resistor 100 k Ω	P-1000686	200
Precision Resistor 100 Ω	P-1009886	200
Precision Resistor 300 k Ω	P-1000690	200
Precision Scale PCB 2000	P-1021079	295
Precision Sphereometer	P-1002947	52
Pressure		86
Pressure Balance	P-1002653	86
Pressure Container for Determining Weight of Air	P-1000796	85
Pressure Sensor	P-1021511	46
Print Cartridge, Black	P-1021628	67
Print Cartridge, Red	P-1021630	67
Prism Table on Stem	P-1003019	159
Prisms		166
Prisms, Set of 3	P-1002863	166
Probe Microphone (230 V, 50/60 Hz)	P-1014520	106
Probe Microphone (115 V, 50/60 Hz)	P-1014521	106
Projectile Launcher	P-1002654	70
Projection Screen	P-1000608	159
Projection Screen K, Transparent	P-1000878	150...151
Projection Screen K, White	P-1000879	150...151
Protective Adapter, 2-Pole	P-1009961	236
Protective Adapter, 3-Pole	P-1009960	236
PTC Resistor, 100 Ω , P2W19	P-1012942	207
PTC Thermistor Probe, 100 Ω	P-1021435	203
Pulley Block with 1 Pulley	P-1003216	62
Pulley Block with 2 Pulleys	P-1003217	62
Pulley Block with 3 Pulleys	P-1003218	62
Pulley with Table Clamp	P-1003221	62
Pulleys and Block and Tackle, Experiment Set	P-1003224	61
Pulse box K	P-1017341	106
Push Button Switch (NC) Sing. Pole P2W19	P-1012989	207
Push Button Switch (NO) Sing. Pole P2W19	P-1012988	207
Pythagorean Cup	P-1002904	87
- Q -		
Quarter-Wavelength Filter on Stem	P-1021353159	252...253
Quincke's Resonance Tube	P-1018475	103
- R -		
Radiation Cartridge, 226Ra, 4 kBq	P-1006797	29, 260
Radiation of Heat		134
Radioactivity		259
Radiography Accessories	P-1000667	258b
Rail Supports, Pair	P-1003044	153
Recording Tuning Fork, c 128 Hz	P-1002606	108
Red LED on 3B Box	P-1010190	198...199
Reflection Blocks with Delay Path, Pair of	P-1002587	114
Refractrometers		290
Regenerative Energy		36

Description	Art. No.	Page
Relative Pressure Sensor FW \pm 100 hPa	P-1021532	47
Relative Pressure Sensor FW \pm 1000 hPa	P-1021533	47
Relay with Change-Over Contact, P4W50	P-1012992	208
Replacement Circuit Board for Tube Holder S	P-4008573	241
Resistance Apparatus	P-1009949	200
Resistance Bridge	P-1009885	200
Resistance Decade 1 k Ω	P-1002733	201
Resistance Decade 1 Ω	P-1002730	201
Resistance Decade 10 k Ω	P-1002734	201
Resistance Decade 10 Ω	P-1002731	201
Resistance Decade 100 Ω	P-1002732	201
Resistance Decade, 1 Ω - 10 k Ω	P-1002735	201
Resistor 1 k Ω , 2 W, P2W19	P-1012916	206
Resistor 1 M Ω , 0.5 W, P2W19	P-1012932	206
Resistor 1 Ω , 2 W, P2W19	P-1012903	206
Resistor 1.5 k Ω , 2 W, P2W19	P-1012917	206
Resistor 10 k Ω , 0.5 W, P2W19	P-1012922	206
Resistor 10 M Ω , 0.5 W, P2W19	P-1012933	206
Resistor 10 Ω , 10 W, P2W19	P-1012905	206
Resistor 10 Ω , 2 W, P2W19	P-1012904	206
Resistor 100 k Ω , 0.5 W, P2W19	P-1012928	206
Resistor 100 Ω , 2 W, P2W19	P-1012910	206
Resistor 15 k Ω , 0.5 W, P2W19	P-1012923	206
Resistor 150 Ω , 2 W, P2W19	P-1012911	206
Resistor 2.2 k Ω , 2 W, P2W19	P-1012918	206
Resistor 22 k Ω , 0.5 W, P2W19	P-1012924	206
Resistor 22 Ω , 2 W, P2W19	P-1012907	206
Resistor 220 k Ω , 0.5 W, P2W19	P-1012929	206
Resistor 220 Ω , 2 W, P2W19	P-1012912	206
Resistor 3.3 k Ω , 2 W, P2W19	P-1012919	206
Resistor 33 k Ω , 0.5 W, P2W19	P-1012925	206
Resistor 330 k Ω , 0.5 W, P2W19	P-1012930	206
Resistor 330 Ω , 2 W, P2W19	P-1012913	206
Resistor 4.7 k Ω , 2 W, P2W19	P-1012920	206
Resistor 47 k Ω , 0.5 W, P2W19	P-1012926	206
Resistor 47 Ω , 2 W, P2W19	P-1012908	206
Resistor 470 k Ω , 0.5 W, P2W19	P-1012931	206
Resistor 470 Ω , 2 W, P2W19	P-1012914	206
Resistor 5,1 Ω , 2 W, P2W19	P-1012906	206
Resistor 6.8 k Ω , 2 W, P2W19	P-1012921	206
Resistor 68 k Ω , 0.5 W, P2W19	P-1012927	206
Resistor 68 Ω , 2 W, P2W19	P-1012909	206
Resistor 680 Ω , 2 W, P2W19	P-1012915	206
Resonance Wire, Ring Shaped	P-1000707	100
Rheostat 1 Ω	P-1003062	201
Rheostat 10 Ω	P-1003064	201
Rheostat 100 Ω	P-1003066	201
Rheostat 1000 Ω	P-1003068	201
Rheostat 3.3 Ω	P-1003063	201
Rheostat 33 Ω	P-1003065	201
Rheostat 330 Ω	P-1003067	201
Rheostat 3300 Ω	P-1003069	201
Riders for Rulers, Set	P-1006494	52
Right Angled Prism	P-1002990	146
Ripple Tank PM02	P-1017591	98
Riser Tubes for Pressure Measurement	P-1002573	117
Rocker Switch, Single Pole, P2W19	P-1012990	207
Rod Clamp with Insulator	P-1001054	197
Rod Thermometer -10 - 100°C	P-1003526	124...125
Rotary Vane Vacuum Pump PK 4 D (230 V, 50/60 Hz)	P-1002919	93
Rotary-Vane Vacuum Pump, One-Stage	P-1012855	92
Rotary-Vane Vacuum Pump, Two-Stage	P-1003317	92
Rotating Base for Leslie cube	P-1017875	134
Rotating Object Holder on Stem	P-1003016	158
Rotating System on Air Bed (115 V, 50/60 Hz)	P-1000781	72
Rotating System on Air Bed (230 V, 50/60 Hz)	P-1000782	72
Rotation Apparatus	P-1006785	73
Rotational Motion		72
Round Cell, 100 mm	P-1002884	175
Round Cell, 200 mm	P-1002885	175
Rowland Grating	P-1002917	162
Rubber Band	P-1000702	100
Rubber Belt for Van de Graaff Generator	P-1002965	190
Ruled Gratings	P-1000600	163
Ruler, 1 m	P-1000742	52
- S -		
Safety Crocodile Clips 4 mm, Set of 6	P-1019218	300

Description	Art. No.	Page	Description	Art. No.	Page
Safety Experiment Leads for Free Fall Apparatus, Set of 3	P-1002848	300	Spectral Lamp Na	P-1003541	176
Safety Experiment Leads, 75 cm, Black, Pair of	P-1002849	300	Spectral Lamp Ne	P-1003543	176
Safety Experiment Leads, 75 cm, Set of 15	P-1002843	300	Spectral Lamp Tl	P-1003544	176
Safety Experiment Leads, 75cm, Red, Pair of	P-1017716	300	Spectrometer-Goniometer S	P-1008673	179
Safety Experiment Leads, 75cm, Red/Blue, Pair of	P-1017718	300	Spectrometers		178
Seals, Set of	P-1002672	139	Spectrometry Supplementary Set	P-1008675	188
SEK - Electronics	P-1021672	20...21	Spectrophotometer S	P-1003061	181
SEK Base Plate	P-1000789	15	Spectroscope in Cardboard Case	P-1003183	178
SEK Electricity and Magnetism	P-1008532	18	Spectroscope in Metal Case	P-1003184	178
SEK Heat	P-1008528	16...17	Spectrum Lamps		176
SEK Mechanical Oscillations and Waves (115 V, 50/60 Hz)	P-1018476	24...25	Spectrum Tube Air	P-1003402	176
SEK Mechanical Oscillations and Waves (230 V, 50/60 Hz)	P-1016652	24...25	Spectrum Tube Argon	P-1003403	176
SEK Mechanics	P-1008527	14	Spectrum Tube Bromine	P-1003404	176
SEK Optics (115 V, 50/60 Hz)	P-1008530	22...23	Spectrum Tube Carbon Dioxide	P-1003405	176
SEK Optics (230 V, 50/60 Hz)	P-1008531	22...23	Spectrum Tube Chlorine	P-1003406	176
SEK Power Supply (115 V, 50/60 Hz)	P-1021687	19	Spectrum Tube Deuterium	P-1003407	176
SEK Power Supply (230 V, 50/60 Hz)	P-1021686	19	Spectrum Tube Helium	P-1003408	176
SEK Radioactivity	P-1006804	28...29	Spectrum Tube Hydrogen	P-1003409	176
SEK Solar Energy (115 V, 50/60 Hz)	P-1017731	30	Spectrum Tube Iodine	P-1003410	176
SEK Solar Energy (230 V, 50/60 Hz)	P-1017732	30	Spectrum Tube Krypton	P-1003411	176
SEK Ultrasonic Waves (115 V, 50/60 Hz)	P-1014529	26...27	Spectrum Tube Mercury	P-1003412	176
SEK Ultrasonic Waves (230 V, 50/60 Hz)	P-1016651	26...27	Spectrum Tube Neon	P-1003413	176
Semi Circular Body, $f = +200$ mm	P-1002989	146	Spectrum Tube Nitrogen	P-1003414	176
Semicircular Cell	P-1003191	149	Spectrum Tube Oxygen	P-1003415	176
Sensor Cable	P-1021514	48	Spectrum Tube Power Supply (115V, 50/60 Hz)	P-1000683	176
Sensor Holder for Stirling Engine G	P-1008500	141	Spectrum Tube Power Supply (230V, 50/60 Hz)	P-1000684	176
Sensors		42	Spectrum Tube Water Vapor	P-1003416	176
Sensors "Mechanical Oscillations" (115 V, 50/60 Hz)	P-1012851	78...79	Spectrum Tube Xenon	P-1003417	176
Sensors "Mechanical Oscillations" (230 V, 50/60 Hz)	P-1012850	78...79	Spectrum Tubes		176
Set of 100 Cuvette Cells, 4 ml	P-1018106	181	Speed of Light		172
Set of 12 Materials with 4 Different Masses each	P-1003500	85	Speed of Light Meter (115 V, 50/60 Hz)	P-1000882	172
Set of 15 Bodies with 2 Different Densities	P-1003501	85	Speed of Light Meter (230 V, 50/60 Hz)	P-1000881	172
Set of 2 Materials with 4 Different Masses each	P-1003499	85	Sphere for Weighing Gases 1000 ml	P-1003519	85
Set of 4 Sensor Cables	P-1021515	48	Spintharoscope	P-1000918	260
Set of Recording Paper	P-1021626	67	Spirit Lamp	P-1003565	289
Shadow Casting Bodies	P-1002992	146	Stability Apparatus	P-1002950	59
Shaker	P-1000581	218	Stable Tube-Type Thermometer -1 – 101°C	P-1003013	124...125
Silicon Diode, 1N 4007, P2W19	P-1012964	207	Stainless Steel Rod 100 mm	P-1002932	298
Silicon Diode, BY 255, P2W19	P-1012961	207	Stainless Steel Rod 1000 mm	P-1002936	298
Silicon photocell BPY47P, P2W19	P-1018844	207	Stainless Steel Rod 1500 mm	P-1002937	298
Simple Machines		61	Stainless Steel Rod 250 mm	P-1002933	298
Sine Wave Generator	P-1001038	277	Stainless Steel Rod 470 mm	P-1002934	298
Single Ray Projector	P-1000682	147	Stainless Steel Rod 750 mm	P-1002935	298
Single Slit N	P-4004002	152	Stainless Steel Rod, 280 mm, 10 mm diam.	P-1012848	298
Single Slits, Set of 5	P-1000846	162	Stainless Steel Rod, 400 mm, 10 mm diam.	P-1012847	298
Single-Throw Switch on Acrylic Base	P-1000961	196	Stand Base, A-Shaped 200 mm	P-1001044	296
Sliding Rider D	P-1002644	154	Stand Base, A-Shaped 280 mm	P-1001043	296
Slit and Hole Diaphragms, Set of 5	P-1000607	161	Stand Equipment "Mechanical Oscillations"	P-1012849	79, 298
Slits and Bars on Glass Plate	P-1008665	164	Stand for Cylindrical Coils	P-1000964	220
Slotted Weights, 10 x 10 g, Set of	P-1003227	56	Stand with H-Shaped Base	P-1018874	296
Slotted Weights, 20 – 100 g, Set of	P-1003226	56	Stands, Clamps and Accessories		296
Slotted Weights, 5 x 100 g, Set of	P-1003229	56	Statics		59
Slotted Weights, 5 x 50 g, Set of	P-1003228	56	Steam Engine B	P-1012801	137
Sodium Fluorescence Tube on Furnace Wall	P-1000913	258	Steam Engine G	P-1002597	137
Soft Iron Bars	P-1003090	215	Steam Generator (115 V, 50/60 Hz)	P-1006769	131
Software "HUE Animation"	P-1021252	293	Steam Generator (230 V, 50/60 Hz)	P-1001049	131
Software Coach 7		37	Steel Balls, Set of 3	P-4003748	71
Solar Energy		120	Steel Balls, Set of 6	P-1002939	68
Solid-State Laser Physics		184	Steel Safe for Radioactive Materials	P-1000920	261
Sound		103	Stefan Boltzmann Lamp	P-1008523	135
Sound Level Meter P5055	P-1002778	285	Stimulation Equipment for Earthworm Experiments	P-1020603	267...269
Sound Sensor	P-1021513	46	Stirling Engine D	P-1000817	142
Spare Bulb for Stroboscope	P-1003332	287	Stirling Engine G	P-1002594	141
Spare Bulbs for Halogen Lamp (230 V, 50/60 Hz)	P-1003536	120	Stirling Engine S	P-1003505	143
Spare Halogen Lamp, 12 V, 50 W	P-1002837	155	Storage Box	P-1003571	150...151
Spare Lamp for Light Box	P-1003231	35	Storing Base for Lenses	P-1003034	159
Spare Sodium Lamp	P-1012885	175	Straight Conductor on Acrylic Base	P-1000926	219
Spare Tube for Pneumatic Lighter	P-1003570	140	Striking Hammer, Hard	P-1002610	109
Spare Tube for X-Ray Apparatus	P-1000664	258a	Striking Hammer, Soft	P-1002614	109
Spectral Lamp Cd	P-1003537	176	Stroboscope, Digital (230 V, 50/60 Hz)	P-1003331	287
Spectral Lamp He	P-1003539	176	Student Experiment Kits (SEK)		14
Spectral Lamp Hg 100	P-1003545	176	Student Experiments		6
Spectral Lamp Hg/Cd	P-1003546	176	STUDENT Kit – Basic Set	P-1000730	6
			STUDENT Kit – Electricity	P-1017213	10...11
			STUDENT Kit – Electrostatics	P-1009883	12
			STUDENT Kit – Heat	P-1000732	8
			STUDENT Kit – Mechanics	P-1000731	7
			STUDENT Kit – Optics (115 V, 50/60 Hz)	P-1000733	9



Description	Art. No.	Page	Description	Art. No.	Page
STUDENT Kit – Optics (230 V, 50/60 Hz)	P-1000734	9	Transistor NPN, BC140, P4W50	P-1018845	208
Supplemental Set “Optics with Laser Ray Box”	P-1003050	148	Transistor PNP, BC160, P4W50	P-1018846	208
Supplementary Kit for Rotating System on Air Bed	P-1000783	72	Transistor PNP, BC 560, P4W50	P-1012977	208
Supplementary Set for Interference	P-1009700	33	Transistor PNP, BD 138, P4W50	P-1012975	208
Supplementary Set for Polarisation	P-1009701	33	Transmission Grating 300 Lines/mm	P-1003080	162
Supplementary Set for Stirling Engine D	P-1008516	142	Transmission Grating 600 Lines/mm	P-1003079	162
Supplementary Set for Torsion Apparatus	P-1018787	89	Transparent Acrylic Plate	P-1000880	195
Support for Optical Bench D	P-1012399	155	Transport Case KL	P-1008651	184...187
Surface Tension		88	Triac, BT 137/800, P4W50	P-1012980	208
Surface Tension Ring	P-1000797	88	Trigger Device for Maxwell's Wheel	P-1018075	69
Suspended Magnet	P-1000943	214	Triode D	P-1000647	234
Switch Box	P-1019301	65	Triode S	P-1000614	239
Switch on 3B-Box	P-1010139	198...199	Triple/Quintuple Slit N	P-4004057	152
Switch, Single, P4W50	P-1012993	208	Tripod Stand 150 mm	P-1002835	296
Swivel Joint for Optical Bench D	P-1002632	155	Tripod Stand 185 mm	P-1002836	296
Swivel Joint with Scale	P-1003043	153	Trolley Track, 1.8m	P-1018102	63
			Tube Holder D	P-1008507	236
			Tube Holder S	P-1014525	241
- T -			Tube Thermometer, Graduated -10 – 110°C	P-1002879	124...125
Table Clamp	P-1002832	297	Tube Thermometer, not Graduated	P-1002880	124...125
Table Top Stop Clock	P-1002809	51	Tube with 6 Induction Coils	P-1001005	225
Table-Top Power Supply	P-1017579	136, 271	Tubing, Silicone 6 mm	P-1002622	303
Tandem Pulley, 2 Pulleys	P-1003222	62	Tungsten Wire	P-1009718	58
Tandem Pulley, 3 Pulleys	P-1003223	62	Tuning Fork 21 Hz with Plotter Pen	P-1000805	108
Temperature Sensor	P-1021499	46	Tuning Fork, 2000 Hz	P-1002609	108
Temperature Sensor	P-1017898	128	Tuning Fork, 440 Hz, on Resonance Box	P-1002613	108
Temperature Sensor NTC	P-1021497	47	Tuning Forks for the C-Major Scale, Set of	P-1002605	109
Temperature Sensor NTC with Measurement			Tuning Forks, 440 Hz, on Resonance Boxes, Pair of	P-1002612	109
Terminal	P-1021797	47, 144	Tuning Forks, C-Major Chord, on Resonance Boxes, Set of	P-1002615	109
Tension Ring DN 10/16 KF	P-1002930	93	Tuning Weights, Pair	P-1002611	109
Tesla Coil Transformer		231	Two Way Ball Valve DN 16 KF	P-1002923	93
Tesla Transformer	P-1000966	231	Two-pole Switch	P-1018439	197
Teslameter E	P-1008537	288	Tyndall's Bar Breaker	P-1000829	130
Teslameter N (115 V, 50/60 Hz)	P-1021671	288	Type K/IR Thermometer	P-1002799	126
Teslameter N (230 V, 50/60 Hz)	P-1021669	288			
Test Bodies for Torsion Axle, Set	P-1008663	82	- U -		
Test Vessel, Complete	P-1002578	112	U Core D	P-1000979	230
Thermal Conductivity Equipment Kit	P-1003497	133	Ultrasonic Adapter Lead	P-1018750	301
Thermal Expansion		130	Ultrasonic Coupling Gel	P-1008575	116
Thermal Imaging Camera	P-1020908	127	Ultrasonic cw Generator with Probe	P-1002576	112
Thermocouple Type K	P-1021498	47	Ultrasonic Doppler Apparatus	P-1002571	117
Thermocouples, Set of 3	P-1017904	124, 202	Ultrasonic Echoscope GS200	P-1018616	113
Thermodynamics		124	Ultrasonic Probe 1MHz GS200	P-1018617	114
Thermometer		124	Ultrasonic Probe 2MHz GS200	P-1018618	114
Thermometer -10 – 150°C	P-1003385	124...125	Ultrasonic Probe 4MHz GS200	P-1018619	114
Thermometer -10°C ... 200°C	P-1003525	124...125	Ultrasonic Probe 2MHz	P-1002582	117
Thermometer -20 – 110°C	P-1003384	124...125	Ultrasound		111
Thermometer -20 – 110°C / 0 – 230°F	P-1003386	124...125	Ultrasound in Solids, Equipment Set	P-1002584	114
Thermometer -20 – 150°C / 0 – 300°F	P-1003387	124...125	Ultrasound Transducer 40 kHz Equipment Kit	P-1009888	111
Thermometer clip	P-1003528	124	Undoped Germanium on Printed Circuit Board	P-1008522	264...265
Thomson Tube S	P-1000617	237	Uniform Acceleration		69
Thyristor, TYN 1012, P4W50	P-1012979	208	Universal Areometer	P-1002876	84
Tilting Rider D	P-1012467	154	Universal Clamp	P-1002830	297
Timer	P-1003009	51	Universal Holder on 3B Box	P-1010156	198...199
Toggle Switch on Acrylic Base	P-1000960	196	Universal Jaw Clamp	P-1002833	297
Torsion Apparatus	P-1018550	89	Universal Spirit Level, 250 mm	P-1002604	59
Torsion Axle	P-1008662	82	Unknown Resistors in 3B Box	P-1012699	198...199
Total Reflection Apparatus on Stem	P-1000857	157	U-Tube Manometer D	P-1009714	86
T-Piece DN 16 KF	P-1002925	93	U-Tube Manometer S	P-1000792	86
T-Piece, BNC	P-1002752	301	UVA Sensor	P-1021504	49
Tracing Compasses, Set of 10	P-1003095	217	UVB Sensor	P-1021505	49
Training Oscilloscope	P-1000902	243			
Transformer 12 V, 25 VA (115 V, 50/60 Hz)	P-1000865	150, 270	- V -		
Transformer 12 V, 25 VA (230 V, 50/60 Hz)	P-1000866	150, 270	Vacuum		90
Transformer 12 V, 60 VA (115 V, 50/60 Hz)	P-1006780	270	Vacuum Bell Jar	P-1020809	91
Transformer 12 V, 60 VA (230 V, 50/60 Hz)	P-1020595	270	Vacuum Chamber with Hand Pump	P-1010126	90
Transformer Core D	P-1000976	228	Vacuum Experiment Plate	P-1003166	91
Transformer Core S	P-1001004	230	Vacuum Hand Pump	P-1012856	92
Transformer with Rectifier 2/ 4/ 6/ 8/ 10/ 12/ 14 V, 5 A (115 V, 50/60 Hz)	P-1003557	271	Vacuum Hose, 10 mm	P-1002620	92, 303
Transformer with Rectifier 2/ 4/ 6/ 8/ 10/ 12/ 14 V, 5 A (230 V, 50/60 Hz)	P-1003558	271	Vacuum Hose, 4 mm	P-1012831	92, 303
Transformer with Rectifier 3/ 6/ 9/ 12 V, 3 A (115 V, 50/60 Hz)	P-1003315	271	Vacuum Hose, 6 mm	P-1012830	92, 303
Transformer with Rectifier 3/ 6/ 9/ 12 V, 3 A (230 V, 50/60 Hz)	P-1003316	271	Vacuum Hose, 8 mm	P-1002619	92, 303
Transistor FET, BF 244, P4W50	P-1012978	208	Vacuum Photocell	P-1000915	251
Transistor NPN, BC 550, P4W50	P-1012976	208	Vacuum Pumps with Flange Connections		93
Transistor NPN, BD 137, P4W50	P-1012974	208	Vacuum Pumps with Hose Connections		92
			Vacuum Recipient	P-1009943	91
			Vacuum Student Kit	P-1003494	34

Description	Art. No.	Page	Description	Art. No.	Page
Van de Graaff Generator (115 V, 50/60 Hz)	P-1002963	190	Weather		122
Van de Graaff Generator (230 V, 50/60 Hz)	P-1002964	190	Weather Station, Wireless	P-1010248	123
Vane Wheel	P-1003101	133	Web Cam	P-1021517	49
Variable g Pendulum	P-1000755	76	Wedge-Shaped Vessel	P-1000794	87
Variable Inductance Coil	P-1003194	226	Weight Holders with Slotted weights, Set of 3	P-1000676	57
Variable leak valve, DN 16 KF	P-1018822	93	Weights 1 g to 1000 g, Set of	P-1003212	56
VDR Resistor, P2W19	P-1018841	207	Weights 1 g to 50 g, Set of	P-1003210	56
Ventilation Valve DN 16 KF	P-1002926	93	Weights 1 g to 500 g, Set of	P-1010189	57
Vernier Model	P-1002951	53	Weights 1 g to 500 g, slotted with Holder, Set of	P-1018597	56
Vertical and Horizontal Trajectories		70	Weights 1 mg to 500 mg, Set of	P-1010234	57
Vertical Ruler, 1 m	P-1000743	52	Weights 10 g to 1000 g, Set of	P-1003214	56
Vessel with Overflow, Transparent	P-1003518	53, 302	Weights 100 g to 2000 g, Set of	P-1001052	56
Vibration Generator	P-1000701	100	Weights with Hooks, Set of	P-1010168	57
Video Cameras		292	Weights, 10 g, Set of 10	P-1000770	56
VinciLab	P-1021477	40	Weights, 20 g, Set of 10	P-1000769	56
VinciLab Stand	P-1021516	49	Weights, 50 g, Set of 10	P-1000771	56
Viscosity		88	Whiteboard 600x900 mm ²	P-1002591	147
Vision Viewer	P-1003436	292	Whiteboard 900x1200 mm ²	P-1002592	147
Volta's Pile on 3B Box	P-1010132	198...199	Wick	P-1001048	289
Voltage Regulating Transformer (230 V, 50/60 Hz)	P-1002772	271	Wide-Band Loudspeaker	P-1000812	111
Voltage Sensor 10 V	P-1021682	44	Wimshurst Machine	P-1002967	190
Voltage Sensor 10 V, Differential	P-1021680	44	Wooden Blocks for Friction Experiments	P-1002944	60
Voltage Sensor 500 mV, Differential	P-1021681	44	Wooden Rulers, 1 m, Set of 10	P-1003233	53
Voltage Supply ±12V P4W50 (115V, 50/60 Hz)	P-1021622	209			
Voltage Supply ±12V P4W50 (230V, 50/60 Hz)	P-1021621	209	- X -		
Voltage Transformer 120 V / 230 V	P-1003649	258b	X-ray Apparatus		258a-h
Voltmeter, AC	P-1002789	280	X-Ray Apparatus (115 V, 50/60 Hz)	P-1000660	258a
Voltmeter, DC	P-1002787	280	X-Ray Apparatus (230 V, 50/60 Hz)	P-1000657	258a
Volume		84	X-Ray Energy Detector	P-1008629	258f...g
Volumetric Dilatometer	P-1018001	132			
			- Y -		
- W -			Young's Modulus Supplementary Set	P-1018528	89
Waltenhofen's Pendulum	P-1000993	226			
Watch Glass Dishes, 120 mm, Set of 10	P-1002869	302	- Z -		
Watch Glass Dishes, 80 mm, Set of 10	P-1002868	302	Zeeman Effect		252
Water Wave Channel	P-1000807	99	Zener Diode, ZPD 18, P2W19	P-1012970	207
Water Waves		98	Zener Diode, ZPD 3.3, P2W19	P-1012965	207
Watt's Governor	P-1009695	73	Zener Diode, ZPD 6.2, P2W19	P-1012967	207
Wave Machine, Manual	P-1003524	102	Zener Diode, ZPD 9.1, P2W19	P-1012966	207
Wave Optics		96	Zener Diode, ZPY 5.6, P2W19	P-1012968	207
Wave Optics Using a Laser		169	Zener Diode, ZPY 8.2, P2W19	P-1012969	207
Wave Optics with Laser, Equipment set for	P-1003053	169	Zero Point Galvanometer CA 403	P-1002726	280
Waveguide Optics, Equipment set	P-1003054	189	Zinc Plates, Set of 10	P-1002713	213
Waves		96	Zinc Sample for Hall Effect	P-1018752	266
Waves and Sound		96	α, β, γ Sensor	P-1021512	48

Art. No.	Page	Art. No.	Page	Art. No.	Page	Art. No.	Page	Art. No.	Page
P-1000011	238	P-1000602	162	P-1000638	262...263	P-1000668	258h	P-1000700	108
P-1000345	116	P-1000603	163	P-1000640	262...263	P-1000669	258h	P-1000701	100
P-1000536	250	P-1000604	146	P-1000642	262...263	P-1000670	258h	P-1000702	100
P-1000537	250	P-1000605	65, 94	P-1000644	236	P-1000674	217	P-1000703	100
P-1000545	45	P-1000606	65, 94	P-1000645	236	P-1000675	156	P-1000704	139
P-1000563	42, 51	P-1000607	161	P-1000646	234	P-1000676	57	P-1000705	101
P-1000564	42	P-1000608	159	P-1000647	234	P-1000680	81, 270	P-1000706	101
P-1000572	205	P-1000611	241	P-1000648	233	P-1000681	81, 270	P-1000707	100
P-1000573	205	P-1000613	239	P-1000649	233	P-1000682	147	P-1000730	6
P-1000580	218	P-1000614	239	P-1000650	233	P-1000683	176	P-1000731	7
P-1000581	218	P-1000615	238	P-1000651	232	P-1000684	176	P-1000732	8
P-1000588	68	P-1000616	238	P-1000653	234	P-1000685	200	P-1000733	9
P-1000590	226	P-1000617	237	P-1000654	235	P-1000686	200	P-1000734	9
P-1000591	220	P-1000618	239	P-1000656	236	P-1000687	200	P-1000735	51
P-1000592	220	P-1000619	239	P-1000657	258a	P-1000688	200	P-1000738	69
P-1000596	163	P-1000620	256...257	P-1000660	258a	P-1000689	200	P-1000740	71
P-1000597	163	P-1000621	256...257	P-1000661	258c	P-1000690	200	P-1000741	55
P-1000598	163	P-1000622	240	P-1000664	258a	P-1000694	59	P-1000742	52
P-1000599	163	P-1000624	242	P-1000665	258c	P-1000695	74	P-1000743	52
P-1000600	163	P-1000633	256...257	P-1000666	258b	P-1000698	74	P-1000747	80
P-1000601	163	P-1000637	262...263	P-1000667	258b	P-1000699	59	P-1000748	80



Art. No.	Page	Art. No.	Page	Art. No.	Page	Art. No.	Page	Art. No.	Page
P-1000752	84	P-1000889	163	P-1001035	259	P-1002707	192	P-1002866	184
P-1000754	84	P-1000891	163	P-1001038	277	P-1002708	192	P-1002867	83
P-1000755	76	P-1000894	120	P-1001040	288	P-1002709	192	P-1002868	302
P-1000756	76	P-1000895	167	P-1001041	101	P-1002710	298	P-1002869	302
P-1000758	94	P-1000901	243	P-1001043	296	P-1002711	213	P-1002870	302
P-1000760	94	P-1000902	243	P-1001044	296	P-1002712	213	P-1002871	302
P-1000761	94	P-1000906	225	P-1001045	296	P-1002713	213	P-1002872	302
P-1000762	75	P-1000912	254...255	P-1001046	296	P-1002714	213	P-1002873	302
P-1000763	75	P-1000913	258	P-1001048	289	P-1002715	213	P-1002874	84
P-1000764	75	P-1000915	251	P-1001049	131	P-1002719	211	P-1002875	84
P-1000765	95	P-1000916	251	P-1001052	56	P-1002721	175	P-1002876	84
P-1000766	85	P-1000917	250	P-1001054	197	P-1002722	29, 259	P-1002877	122
P-1000768	83	P-1000918	260	P-1001055	303	P-1002726	280	P-1002879	124...125
P-1000769	56	P-1000920	261	P-1001057	174	P-1002730	201	P-1002880	124...125
P-1000770	56	P-1000921	260	P-1002571	117	P-1002731	201	P-1002881	124...125
P-1000771	56	P-1000923	191	P-1002572	117	P-1002732	201	P-1002882	135
P-1000781	72	P-1000925	219	P-1002573	117	P-1002733	201	P-1002884	175
P-1000782	72	P-1000926	219	P-1002574	116	P-1002734	201	P-1002885	175
P-1000783	72	P-1000927	219	P-1002575	118	P-1002735	201	P-1002889	132
P-1000786	55	P-1000928	219	P-1002576	112	P-1002736	201	P-1002891	87
P-1000789	15	P-1000929	214	P-1002577	112	P-1002737	201	P-1002892	86
P-1000790	69	P-1000936	195	P-1002578	112	P-1002746	301	P-1002894	140
P-1000791	83	P-1000938	192	P-1002579	112	P-1002748	301	P-1002895	140
P-1000792	86	P-1000942	218	P-1002582	117	P-1002749	301	P-1002897	213
P-1000793	87, 303	P-1000943	214	P-1002584	114	P-1002750	301	P-1002898	212
P-1000794	87	P-1000946	196	P-1002585	114	P-1002751	301	P-1002899	212
P-1000796	85	P-1000947	196	P-1002586	114	P-1002752	301	P-1002903	133
P-1000797	88	P-1000948	197	P-1002587	114	P-1002769	272	P-1002904	87
P-1000798	92	P-1000949	196	P-1002588	115	P-1002771	274	P-1002905	242
P-1000801	69	P-1000950	196	P-1002589	115	P-1002772	271	P-1002911	179
P-1000804	110	P-1000951	196	P-1002590	115	P-1002778	285	P-1002917	162
P-1000805	108	P-1000953	196	P-1002591	147	P-1002779	285	P-1002919	93
P-1000806	110	P-1000954	196	P-1002592	147	P-1002780	285	P-1002923	93
P-1000807	99	P-1000955	196	P-1002594	141	P-1002781	282	P-1002924	93
P-1000808	101	P-1000956	196	P-1002597	137	P-1002783	282	P-1002925	93
P-1000811	111	P-1000957	196	P-1002598	143	P-1002784	283	P-1002926	93
P-1000812	111	P-1000958	196	P-1002599	143	P-1002785	282	P-1002927	93
P-1000814	103	P-1000959	196	P-1002600	52	P-1002786	280	P-1002928	93
P-1000815	103	P-1000960	196	P-1002601	52	P-1002787	280	P-1002929	93
P-1000816	13	P-1000961	196	P-1002602	52	P-1002788	280	P-1002930	93
P-1000817	142	P-1000962	196	P-1002603	52	P-1002789	280	P-1002931	93
P-1000819	144	P-1000964	220	P-1002604	59	P-1002790	280	P-1002932	298
P-1000820	144	P-1000965	220	P-1002605	109	P-1002791	127	P-1002933	298
P-1000822	129	P-1000966	231	P-1002606	108	P-1002793	127	P-1002934	298
P-1000823	128	P-1000967	231	P-1002607	108	P-1002794	127	P-1002935	298
P-1000824	134	P-1000968	224	P-1002608	108	P-1002795	122	P-1002936	298
P-1000827	130	P-1000972	192	P-1002609	108	P-1002799	126	P-1002937	298
P-1000828	130	P-1000976	228	P-1002610	109	P-1002802	285	P-1002939	68
P-1000829	130	P-1000977	230	P-1002611	109	P-1002803	125	P-1002940	59
P-1000830	131	P-1000978	230	P-1002612	109	P-1002804	124	P-1002941	296
P-1000831	130	P-1000979	230	P-1002613	108	P-1002805	124	P-1002942	296
P-1000832	303	P-1000980	229	P-1002614	109	P-1002806	289	P-1002943	296
P-1000833	303	P-1000981	229	P-1002615	109	P-1002807	289	P-1002944	60
P-1000834	303	P-1000982	229	P-1002619	92, 303	P-1002808	289	P-1002945	55
P-1000835	134	P-1000983	229	P-1002620	92, 303	P-1002809	51	P-1002946	55
P-1000837	121	P-1000984	228	P-1002622	303	P-1002810	51	P-1002947	52
P-1000839	120	P-1000985	228	P-1002628	154	P-1002811	51	P-1002950	59
P-1000841	152	P-1000986	228	P-1002629	154	P-1002827	297	P-1002951	53
P-1000842	152	P-1000987	228	P-1002630	154	P-1002828	297	P-1002952	84
P-1000843	152	P-1000988	228	P-1002632	155	P-1002829	297	P-1002953	84
P-1000844	152	P-1000989	228	P-1002635	154	P-1002830	297	P-1002954	84
P-1000845	152	P-1000990	228	P-1002637	154	P-1002831	297	P-1002955	84
P-1000846	162	P-1000991	228	P-1002639	154	P-1002832	297	P-1002956	81
P-1000848	161	P-1000992	229	P-1002644	154	P-1002833	297	P-1002957	86
P-1000850	150...151	P-1000993	226	P-1002646	155	P-1002834	296	P-1002959	110
P-1000852	177, 251	P-1000994	204	P-1002649	160	P-1002835	296	P-1002960	110
P-1000853	156	P-1000995	197	P-1002651	183	P-1002836	296	P-1002963	190
P-1000854	156	P-1000999	230	P-1002652	183	P-1002837	155	P-1002964	190
P-1000855	158	P-1001000	230	P-1002653	86	P-1002838	299	P-1002965	190
P-1000856	158	P-1001001	230	P-1002654	70	P-1002839	299	P-1002967	190
P-1000857	157	P-1001002	230	P-1002655	70	P-1002840	299	P-1002970	197
P-1000862	150...151	P-1001003	230	P-1002656	71	P-1002841	299	P-1002975	218
P-1000863	150...151	P-1001004	230	P-1002657	71	P-1002843	300	P-1002976	218
P-1000865	150, 270	P-1001005	225	P-1002658	128	P-1002847	299	P-1002977	131
P-1000866	150, 270	P-1001006	272	P-1002659	128	P-1002848	300	P-1002978	131
P-1000868	150...151	P-1001007	272	P-1002660	223	P-1002849	300	P-1002983	170
P-1000869	150...151	P-1001012	275	P-1002661	223	P-1002850	299	P-1002984	146
P-1000871	150...151	P-1001014	270	P-1002662	223	P-1002851	300	P-1002985	146
P-1000878	150...151	P-1001024	192	P-1002670	138	P-1002858	166	P-1002986	146
P-1000879	150...151	P-1001025	192	P-1002671	139	P-1002859	166	P-1002987	146
P-1000880	195	P-1001026	192	P-1002672	139	P-1002860	166	P-1002988	146
P-1000881	172	P-1001027	191	P-1002689	36, 121	P-1002861	166	P-1002989	146
P-1000882	172	P-1001028	287	P-1002702	55	P-1002862	167	P-1002990	146
P-1000885	162	P-1001032	51, 259	P-1002703	55	P-1002863	166	P-1002992	146
P-1000886	161	P-1001033	51, 259	P-1002704	55	P-1002864	166	P-1002993	149
P-1000887	150...151	P-1001034	51, 286	P-1002705	170	P-1002865	166	P-1003009	51

Art. No.	Page	Art. No.	Page	Art. No.	Page	Art. No.	Page	Art. No.	Page
P-1003010	126	P-1003169	91	P-1003387	124...125	P-1006494	52	P-1009696	150...151
P-1003011	122	P-1003170	91	P-1003402	176	P-1006769	131	P-1009699	150...151
P-1003012	84	P-1003177	162	P-1003403	176	P-1006780	270	P-1009700	33
P-1003013	124...125	P-1003178	163	P-1003404	176	P-1006784	95	P-1009701	33
P-1003014	124...125	P-1003179	163	P-1003405	176	P-1006785	73	P-1009710	215
P-1003016	158	P-1003180	163	P-1003406	176	P-1006791	152	P-1009714	86
P-1003017	159	P-1003181	163	P-1003407	176	P-1006794	254...255	P-1009715	87
P-1003019	159	P-1003183	178	P-1003408	176	P-1006795	254...255	P-1009716	227
P-1003022	157	P-1003184	178	P-1003409	176	P-1006796	258	P-1009718	58
P-1003023	157	P-1003185	165	P-1003410	176	P-1006797	29, 260	P-1009733	155
P-1003024	157	P-1003186	165	P-1003411	176	P-1006798	195	P-1009738	54
P-1003025	157	P-1003187	149	P-1003412	176	P-1006799	217	P-1009739	54
P-1003026	157	P-1003189	171	P-1003413	176	P-1006804	28...29	P-1009740	54
P-1003027	157	P-1003190	302	P-1003414	176	P-1006813	192	P-1009741	54
P-1003028	157	P-1003191	149	P-1003415	176	P-1006858	204	P-1009760	264...265
P-1003029	157	P-1003192	217	P-1003416	176	P-1006889	53	P-1009764	121
P-1003031	157	P-1003193	220	P-1003417	176	P-1007027	88, 303	P-1009765	218
P-1003032	157	P-1003194	226	P-1003419	294	P-1007112	63, 303	P-1009810	264...265
P-1003033	157	P-1003195	176	P-1003421	294	P-1008500	141	P-1009843	200
P-1003034	159	P-1003197	176	P-1003433	295	P-1008505	245	P-1009844	200
P-1003036	153	P-1003201	156	P-1003434	295	P-1008506	256...257	P-1009861	150...151
P-1003038	155	P-1003202	156	P-1003436	292	P-1008507	236	P-1009863	150...151
P-1003039	153	P-1003203	158	P-1003491	102	P-1008508	258c	P-1009864	150...151
P-1003040	153	P-1003204	164	P-1003492	102	P-1008513	59	P-1009865	150...151
P-1003041	153	P-1003208	90	P-1003494	34	P-1008516	142	P-1009866	150...151
P-1003042	153	P-1003210	56	P-1003495	86	P-1008518	150...151	P-1009883	12
P-1003043	153	P-1003212	56	P-1003496	90	P-1008519	150...151	P-1009884	193
P-1003044	153	P-1003213	62	P-1003497	133	P-1008522	264...265	P-1009885	200
P-1003048	191	P-1003214	56	P-1003498	84	P-1008523	135	P-1009886	200
P-1003049	148	P-1003216	62	P-1003499	85	P-1008524	196	P-1009887	200
P-1003050	148	P-1003217	62	P-1003500	85	P-1008525	230	P-1009888	111
P-1003051	148	P-1003218	62	P-1003501	85	P-1008527	14	P-1009924	110
P-1003052	148	P-1003221	62	P-1003502	34	P-1008528	16...17	P-1009925	150...151
P-1003053	169	P-1003222	62	P-1003505	143	P-1008530	22...23	P-1009926	150...151
P-1003054	189	P-1003223	62	P-1003507	212	P-1008531	22...23	P-1009927	150...151
P-1003055	189	P-1003224	61	P-1003508	212	P-1008532	18	P-1009929	150...151
P-1003056	148	P-1003226	56	P-1003509	87	P-1008534	273	P-1009931	32
P-1003057	149	P-1003227	56	P-1003510	87	P-1008535	273	P-1009932	32
P-1003058	149	P-1003228	56	P-1003511	132	P-1008537	288	P-1009934	264...265
P-1003059	160	P-1003229	56	P-1003512	133	P-1008539	62	P-1009935	230
P-1003061	181	P-1003230	75	P-1003515	55	P-1008540	100	P-1009942	60
P-1003062	201	P-1003231	35	P-1003516	99	P-1008575	116	P-1009943	91
P-1003063	201	P-1003232	195	P-1003518	53, 302	P-1008629	258f...g	P-1009946	152
P-1003064	201	P-1003233	53	P-1003519	85	P-1008631	283	P-1009948	245
P-1003065	201	P-1003235	77	P-1003520	110	P-1008632	184...187	P-1009949	200
P-1003066	201	P-1003237	220	P-1003521	110	P-1008634	184...187	P-1009950	96...97
P-1003067	201	P-1003251	222	P-1003522	110	P-1008635	184...187	P-1009951	96...97
P-1003068	201	P-1003253	129	P-1003523	110	P-1008636	184...187	P-1009956	276
P-1003069	201	P-1003254	129	P-1003524	102	P-1008637	184...187	P-1009957	276
P-1003078	178	P-1003255	129	P-1003525	124...125	P-1008638	184...187	P-1009959	227
P-1003079	162	P-1003256	129	P-1003526	124...125	P-1008639	184...187	P-1009960	236
P-1003080	162	P-1003257	129	P-1003528	124	P-1008640	184...187	P-1009961	236
P-1003081	163	P-1003258	129	P-1003531	178	P-1008641	184...187	P-1009962	191
P-1003082	162	P-1003307	274	P-1003532	150...151	P-1008642	184...187	P-1009963	191
P-1003084	165	P-1003308	274	P-1003533	150...151	P-1008646	184...187	P-1009964	191
P-1003085	214	P-1003309	274	P-1003534	302	P-1008648	184...187	P-1010114	302
P-1003086	214	P-1003310	274	P-1003536	120	P-1008651	184...187	P-1010125	90
P-1003088	214	P-1003311	274	P-1003537	176	P-1008652	167	P-1010126	90
P-1003089	214	P-1003312	274	P-1003539	176	P-1008653	139	P-1010132	198...199
P-1003090	215	P-1003315	271	P-1003541	176	P-1008654	139	P-1010137	197
P-1003091	215	P-1003316	271	P-1003543	176	P-1008659	160	P-1010138	198...199
P-1003092	218	P-1003317	92	P-1003544	176	P-1008661	58	P-1010139	198...199
P-1003093	217	P-1003321	146	P-1003545	176	P-1008662	82	P-1010140	197
P-1003095	217	P-1003322	146	P-1003546	176	P-1008663	82	P-1010141	197
P-1003096	215	P-1003323	147	P-1003549	254...255	P-1008664	164	P-1010142	197
P-1003101	133	P-1003324	147	P-1003554	214	P-1008665	164	P-1010143	197
P-1003102	54	P-1003331	287	P-1003555	216	P-1008666	164	P-1010144	197
P-1003103	54	P-1003332	287	P-1003556	214	P-1008668	158	P-1010145	197
P-1003104	54, 60	P-1003334	126	P-1003557	271	P-1008669	160	P-1010146	198...199
P-1003105	54, 60	P-1003335	126	P-1003558	271	P-1008670	165	P-1010152	198...199
P-1003106	54	P-1003337	58	P-1003560	273	P-1008671	165	P-1010154	198...199
P-1003107	54, 60	P-1003339	172	P-1003562	272	P-1008672	165	P-1010155	198...199
P-1003108	54	P-1003368	51	P-1003565	289	P-1008673	179	P-1010156	198...199
P-1003109	55	P-1003369	51	P-1003566	289	P-1008674	188	P-1010157	198...199
P-1003110	54	P-1003370	54	P-1003569	140	P-1008675	188	P-1010158	198...199
P-1003112	214	P-1003371	54	P-1003570	140	P-1008676	278	P-1010168	57
P-1003114	214	P-1003372	54	P-1003571	150...151	P-1008687	99	P-1010175	170
P-1003157	177	P-1003373	54	P-1003593	231, 273	P-1008691	273	P-1010181	301
P-1003158	177	P-1003374	54	P-1003649	258b	P-1008692	231, 293	P-1010189	57
P-1003159	177	P-1003375	54	P-1003806	35	P-1008695	279	P-1010190	198...199
P-1003161	177	P-1003376	55	P-1005278	249	P-1008696	175	P-1010191	198...199
P-1003162	177	P-1003382	130	P-1005279	248	P-1008707	261	P-1010192	198...199
P-1003163	177	P-1003383	133	P-1005290	248	P-1008708	261	P-1010194	170
P-1003164	159	P-1003384	124...125	P-1005291	249	P-1009497	184...187	P-1010195	197
P-1003165	156	P-1003385	124...125	P-1005406	291	P-1009545	270	P-1010196	197
P-1003166	91	P-1003386	124...125	P-1005408	156	P-1009695	73	P-1010197	197



Art. No.	Page	Art. No.	Page	Art. No.	Page	Art. No.	Page	Art. No.	Page
P-1010198	197	P-1012915	206	P-1013526	281	P-1018528	89	P-1021406	194
P-1010199	197	P-1012916	206	P-1013527	281	P-1018550	89	P-1021409	176
P-1010214	53	P-1012917	206	P-1013825	198...199	P-1018551	107	P-1021413	203
P-1010217	52	P-1012918	206	P-1013843	245	P-1018597	56	P-1021435	203
P-1010219	126	P-1012919	206	P-1013885	232	P-1018616	113	P-1021440	290
P-1010234	57	P-1012920	206	P-1013889	240	P-1018617	114	P-1021441	290
P-1010248	123	P-1012921	206	P-1013905	204	P-1018618	114	P-1021443	102
P-1010250	122	P-1012922	206	P-1013906	204	P-1018619	114	P-1021477	40
P-1010252	289	P-1012923	206	P-1013907	246	P-1018624	34	P-1021478	41
P-1010255	289	P-1012924	206	P-1014520	106	P-1018750	301	P-1021497	47
P-1010300	150...151	P-1012925	206	P-1014521	106	P-1018751	266	P-1021498	47
P-1011346	198...199	P-1012926	206	P-1014525	241	P-1018752	266	P-1021499	46
P-1011739	289	P-1012927	206	P-1014529	26...27	P-1018787	89	P-1021500	49
P-1012399	155	P-1012928	206	P-1014616	294	P-1018820	168	P-1021502	48
P-1012400	154	P-1012929	206	P-1014617	182	P-1018822	93	P-1021503	48
P-1012401	154	P-1012930	206	P-1014618	166	P-1018832	283	P-1021504	49
P-1012467	154	P-1012931	206	P-1014620	164	P-1018837	207	P-1021505	49
P-1012514	93	P-1012932	206	P-1014621	164	P-1018839	207	P-1021510	46
P-1012694	198...199	P-1012933	206	P-1014622	161	P-1018841	207	P-1021511	46
P-1012695	198...199	P-1012934	208	P-1016651	26...27	P-1018842	207	P-1021512	48
P-1012696	198...199	P-1012935	208	P-1016652	24...25	P-1018844	207	P-1021513	46
P-1012697	198...199	P-1012936	208	P-1017213	10...11	P-1018845	208	P-1021514	48
P-1012698	198...199	P-1012937	208	P-1017284	182	P-1018846	208	P-1021515	48
P-1012699	198...199	P-1012938	208	P-1017329	136	P-1018847	208	P-1021516	49
P-1012741	123	P-1012939	208	P-1017330	136	P-1018874	296	P-1021517	49
P-1012801	137	P-1012940	207	P-1017331	136	P-1018882	247	P-1021518	37
P-1012816	284	P-1012941	207	P-1017332	68	P-1018884	247	P-1021522	37
P-1012817	284	P-1012942	207	P-1017333	106	P-1018889	215	P-1021524	37
P-1012818	254...255	P-1012943	206	P-1017334	106	P-1019180	65	P-1021532	47
P-1012819	254...255	P-1012944	206	P-1017337	276	P-1019196	180...181	P-1021533	47
P-1012820	258	P-1012945	206	P-1017338	276	P-1019212	221	P-1021534	42
P-1012827	88	P-1012946	206	P-1017339	104...105	P-1019216	258b	P-1021536	247
P-1012830	92, 303	P-1012947	206	P-1017340	104...105	P-1019218	300	P-1021621	209
P-1012831	92, 303	P-1012948	206	P-1017341	106	P-1019219	299	P-1021622	209
P-1012832	286	P-1012949	206	P-1017342	104...105	P-1019234	275	P-1021623	66...67
P-1012833	286	P-1012950	206	P-1017344	106	P-1019300	65	P-1021624	67
P-1012836	248	P-1012951	206	P-1017366	140	P-1019301	65	P-1021626	67
P-1012837	249	P-1012952	206	P-1017531	76	P-1019304	247	P-1021628	67
P-1012844	78...79	P-1012953	206	P-1017579	136, 271	P-1019388	266	P-1021630	67
P-1012847	298	P-1012954	206	P-1017591	98	P-1019957	244	P-1021647	83
P-1012848	298	P-1012955	206	P-1017655	246	P-1020138	275	P-1021669	288
P-1012849	79, 298	P-1012956	206	P-1017716	300	P-1020250	291	P-1021671	288
P-1012850	78...79	P-1012957	206	P-1017718	300	P-1020595	270	P-1021672	20...21
P-1012851	78...79	P-1012958	206	P-1017725	275	P-1020599	267...269	P-1021673	41
P-1012853	78...79	P-1012959	206	P-1017729	135	P-1020600	267...269	P-1021674	43
P-1012854	78...79	P-1012960	206	P-1017730	135	P-1020601	267...269	P-1021675	43
P-1012855	92	P-1012961	207	P-1017731	30	P-1020602	267...269	P-1021676	43
P-1012856	92	P-1012962	207	P-1017732	30	P-1020603	267...269	P-1021677	43
P-1012857	274	P-1012963	207	P-1017734	31	P-1020605	267...269	P-1021678	44
P-1012859	229	P-1012964	207	P-1017735	31	P-1020630	155	P-1021679	44
P-1012860	173	P-1012965	207	P-1017780	210	P-1020742	266, 287	P-1021680	44
P-1012861	173	P-1012966	207	P-1017781	210	P-1020744	266, 287	P-1021681	44
P-1012862	131	P-1012967	207	P-1017782	119	P-1020769	145	P-1021682	44
P-1012863	158	P-1012968	207	P-1017783	119	P-1020809	91	P-1021683	42
P-1012865	284	P-1012969	207	P-1017784	119	P-1020857	278	P-1021684	44
P-1012868	258h	P-1012970	207	P-1017785	119	P-1020859	295	P-1021685	45
P-1012869	116	P-1012971	207	P-1017801	224	P-1020860	295	P-1021686	19
P-1012870	140	P-1012972	207	P-1017806	206	P-1020903	252...253	P-1021687	19
P-1012871	258d...e	P-1012973	207	P-1017870	297	P-1020907	53	P-1021688	48
P-1012872	57	P-1012974	208	P-1017874	184...187	P-1020908	127	P-1021719	171
P-1012873	300	P-1012975	208	P-1017875	134	P-1020909	127	P-1021766	45
P-1012880	118	P-1012976	208	P-1017879	184	P-1020910	279	P-1021790	36
P-1012883	175	P-1012977	208	P-1017895	280	P-1020911	279	P-1021797	47, 144
P-1012884	175	P-1012978	208	P-1017897	128	P-1020912	277	P-1021798	45
P-1012885	175	P-1012979	208	P-1017898	128	P-1020913	277	P-1021799	194
P-1012886	137	P-1012980	208	P-1017899	128	P-1021079	295	P-1021806	73, 227
P-1012887	137	P-1012981	208	P-1017904	124, 202	P-1021090	64	P-1021822	222
P-1012889	213	P-1012982	208	P-1018001	132	P-1021091	272	P-1021824	57, 83
P-1012890	213	P-1012983	207	P-1018065	193, 302	P-1021092	272	P-4000036	132, 302
P-1012892	288	P-1012984	207	P-1018075	69	P-1021155	129	P-4003748	71
P-1012894	260	P-1012985	209	P-1018102	63	P-1021156	102	P-4003876	60
P-1012899	270	P-1012986	209	P-1018103	180...181	P-1021162	247, 292	P-4003987	152
P-1012900	270	P-1012987	209	P-1018104	180...181	P-1021164	292	P-4004002	152
P-1012902	206	P-1012988	207	P-1018106	181	P-1021167	293	P-4004057	152
P-1012903	206	P-1012989	207	P-1018347	294	P-1021249	290	P-4008112	97
P-1012904	206	P-1012990	207	P-1018439	197	P-1021250	179, 290	P-4008308	104...105
P-1012905	206	P-1012991	208	P-1018448	69, 298	P-1021252	293	P-4008573	241
P-1012906	206	P-1012992	208	P-1018449	298	P-1021347	202	P-4008614	254...255
P-1012907	206	P-1012993	208	P-1018466	77	P-1021353	252...253	P-5006578	269
P-1012908	206	P-1012994	209	P-1018468	107	P-1021364	252...253	P-5006663	167
P-1012909	206	P-1012995	207	P-1018469	107	P-1021365	252...253		
P-1012910	206	P-1013123	216	P-1018471	35	P-1021366	252...253		
P-1012911	206	P-1013131	225	P-1018475	103	P-1021367	252...253		
P-1012912	206	P-1013228	74	P-1018476	24...25	P-1021369	190		
P-1012913	206	P-1013393	174	P-1018478	221	P-1021376	293		
P-1012914	206	P-1013412	275	P-1018527	89	P-1021405	194		



Advantages of 3B Scientific® Animal Specimens

- Completely genuine animal specimens
- No animals have been bred or killed solely for the purpose of making these specimens
- Only adult animals with closed epiphyseal plates used
- Origin and preparation of animals conform to legal stipulations
- Expert European manufacture, professionally prepared
- No risk of infection due to infectious zoonotic pathogens (certified)
- Depiction of natural animal anatomy
- All bones, no matter how tiny are mounted
- No yellowing
- Perfect for lessons on comparative anatomy, e.g. animals – humans

Note:

Shape, dimensions, weight and number of bones may vary

Horse (*Equus ferus caballus*)

Taxonomy:

Class: Mammals
 Order: Odd-toed ungulates
 Family: Horses
 Diet: Herbivore
 Size: approx. 50 – 200 cm
 Weight: approx. 100 – 1200 kg
 Age: approx. 20 – 50 years
 Skeleton: approx. 252 individual bones

Dentition formula:

Number: 36 – 44
 Incisors (I): 3/3
 Canines (C): 0-1/0-1
 Premolars (P): 3-4/3-4
 Molars (M): 3/3



Horse Skeleton (*Equus ferus caballus*)

The real bone specimen of an adult horse is composed of approximately 252 individual bones. It represents a typical example of the order of odd-toed ungulates. There are only minimal differences in body plan between the different breeds of horses. You can choose between a female or a male item. The skeleton is mounted on a moveable base plate.

Length: approx. 250 – 300 cm
 Width: approx. 60 – 70 cm
 Height at withers: approx. 140 – 170 cm
 Weight: approx. 170 – 200 kg

♀ Horse Skeleton (*Equus ferus caballus*),
 Female, Specimen
 P-1021002

♂ Horse Skeleton (*Equus ferus caballus*),
 Male, Specimen
 P-1021003



Stratovolcano

This hand-painted model shows the inside of a stratovolcano with the path of liquid magma to earth's surface.

Material: PVC
 Dimensions: approx. 470x350x190 mm³
 Weight: approx. 2.4 kg
P-1017595

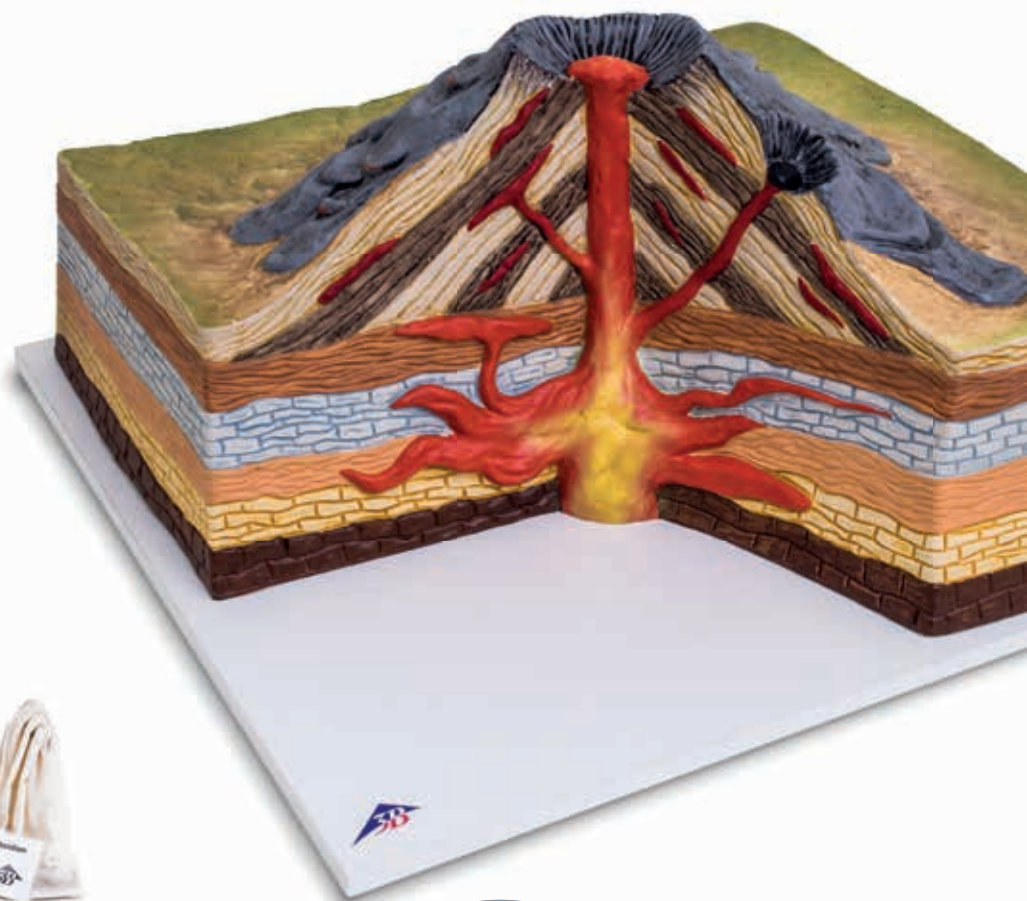

Set of Three Volcanic Rocks

Set of three vulcanite rocks consisting of three little bags, each containing ten pieces of either lava rock, obsidian orpumice stone.

P-1018462

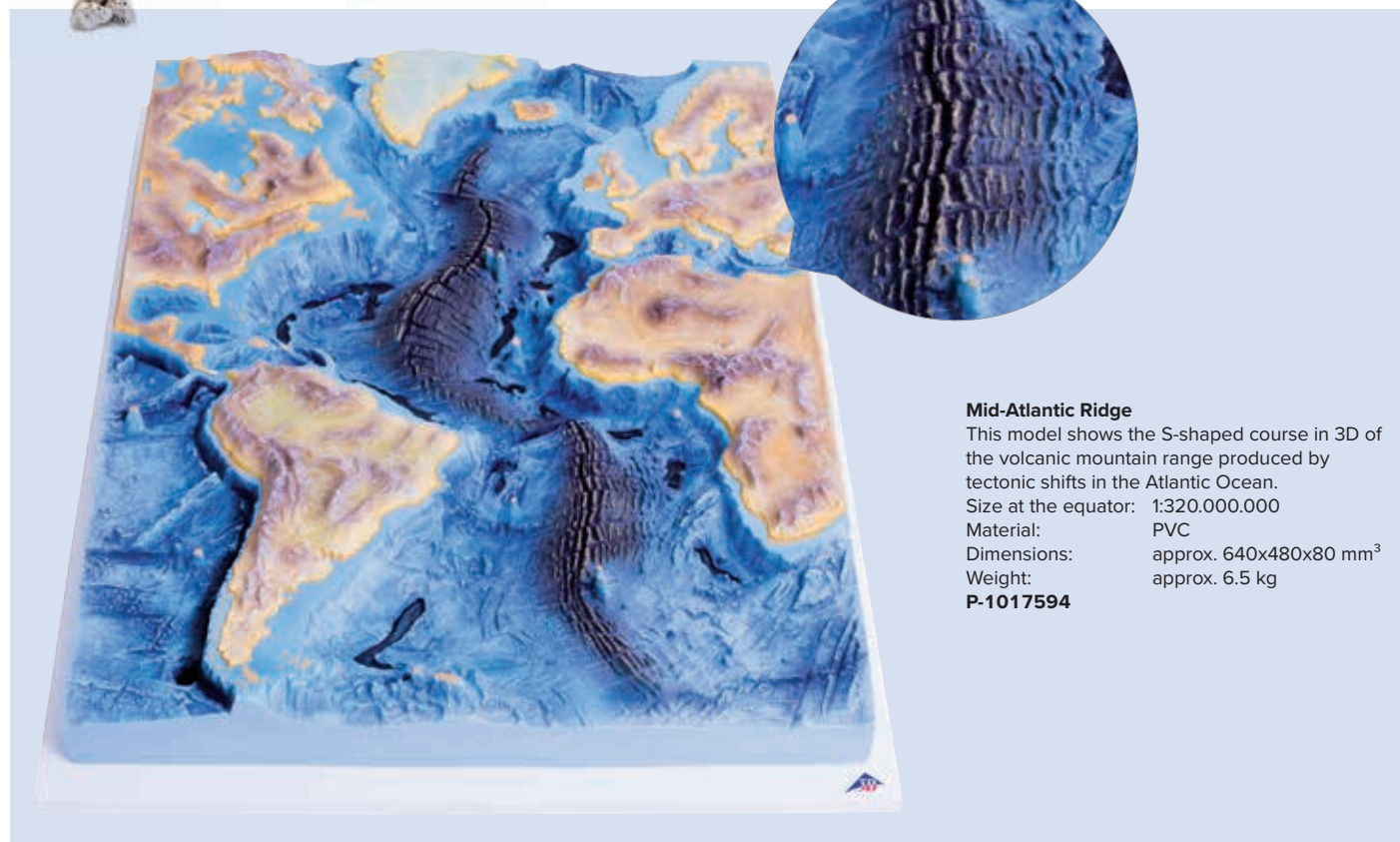

Mid-Atlantic Ridge

This model shows the S-shaped course in 3D of the volcanic mountain range produced by tectonic shifts in the Atlantic Ocean.

Size at the equator: 1:320.000.000
 Material: PVC
 Dimensions: approx. 640x480x80 mm³
 Weight: approx. 6.5 kg
P-1017594



Dissecting Set DS14

Stainless steel instruments in carry case. Fully autoclavable.
P-1021245

Contents:

- 1 scalpel handle no. 3
- 5 scalpel blades no. 10 for handle no. 3
- 1 surgical scissors, pointed / blunt, straight, 14 cm
- 1 dissecting scissors, pointed / pointed, ring grip, 11.5 cm
- 1 dissecting forceps, pointed / straight, serrated, 12.5 cm
- 1 anatomical tweezers, blunt / straight, 11.5 cm
- 1 lancet needle, metal, straight, 15 cm
- 1 dissecting needle, metal, straight, blunt
- 1 dissecting needle, metal, angled, blunt
- 1 section lifter, 16 cm
- 2 Farabeuf retractor, blunt, 12 cm
- 1 artery forceps, straight, 14 cm
- 1 artery forceps, angled, 14 cm
- 1 ruler, metal, 15 cm



Dissecting Set DS6

Stainless steel instruments in carry case.
P-1021246

Contents:

- 1 scalpel handle no. 4
- 5 scalpel blades no. 22 for handle no. 4
- 1 dissecting scissors, pointed / pointed, ring grip, 11.5 cm
- 1 dissecting forceps, pointed / straight, serrated, 12.5 cm
- 1 dissecting needle with plastic handle, straight, pointed
- 1 dissecting needle with plastic handle, angled, pointed



Dissecting Set DS8

Stainless steel instruments in carry case.
P-1005964

Contents:

- 1 scalpel handle no. 4
- 5 scalpel blades no. 22 for handle no. 4
- 1 surgical scissors, pointed / blunt, straight, 14 cm
- 1 anatomical tweezers, blunt / straight, 11.5 cm
- 1 dissecting needle with plastic handle, straight, pointed
- 1 dissecting needle with plastic handle, curved, pointed
- 1 pipette 2 ml, 11 cm
- 1 ruler, plastic, 15 cm



Dissecting Set DS9

Stainless steel instruments in carry case. Fully autoclavable.
P-1003771

Contents:

- 1 scalpel handle no. 4
- 5 scalpel blades no. 22 for handle no. 4
- 1 scalpel with 4 cm blade
- 1 dissecting scissors, pointed / pointed, ring grip, 11.5 cm
- 1 dissecting forceps, pointed / straight, serrated, 12.5 cm
- 1 anatomical tweezers, blunt / straight, 11.5 cm
- 1 tweezers, 11 cm
- 1 lancet needle, metal, straight, 15 cm
- 1 dissecting needle, metal, straight, pointed

Dissection Dish, Stainless Steel

High-quality specimen dish made of rust-free stainless steel. Ideal for preparing specimens in classrooms and laboratories. Includes separate, washable, long-life specimen preparation mat. Stackable. Suitable for autoclaves.
 Dimensions: approx. 30.5x20x4 cm³
P-1021248



Dissection Dish, Plastic

Robust, non-breakable and non-leak HDPE polythene dissection dish. Includes separate, washable, long-life specimen preparation mat with smooth surface. Stackable. Not suitable for use with wax. Not suitable for autoclaves.
 Dimensions: approx. 32x23x4 cm³
P-1021247



3B SCIENTIFIC® PRODUCT RANGE



MEDICAL SIMULATION

Simulators and skills trainers enable students to develop or enhance their knowledge, skills, or to analyze and respond to realistic situations in a simulated environment, and to gain competence and confidence. You will find simulators and skills trainers for all your training needs manufactured to meet all your standards at 3bscientific.com.

MEDICAL EDUCATION

Anatomical models are an essential teaching tool in medical education both for students and patients. Cast from actual specimens, 3B Scientific's anatomy models are professionally manufactured to meet medical quality standards. All models are hand-painted, made from medical quality phthalate free plastics and lead free paints, and are compliant to the EU REACH regulation. The 3B Scientific brand name represents quality materials, superior craftsmanship and a 3-year quality guarantee.

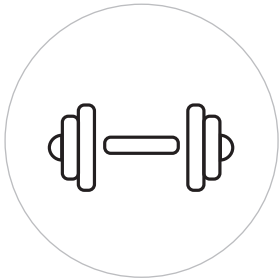

HEALTHCARE AND HEALTH EDUCATION

3B Scientific has for more than 7 decades focused on providing life-like learning experiences and expanded into patient education for practitioners. In addition to medical simulators and anatomical models for medical education the company provides supplies and devices for healthcare practitioners such as physiotherapists, chiropractors, natural-health professionals, and acupuncturists. Finding the right products is now faster than it has ever been. Visit 3bscientific.com to see the full range of therapy and fitness equipment and accessories.

ACUPUNCTURE

Traditional Chinese Medicine (TCM) treats the body as a whole. Today, the integration of eastern and western medicine is growing at a fast pace and clinics and hospitals are providing acupuncture treatments. The quality of the tools and needles used during the treatments is of highest importance for the comfort of the patients. 3B Scientific offers high quality acupuncture needles and tools at competitive prices.

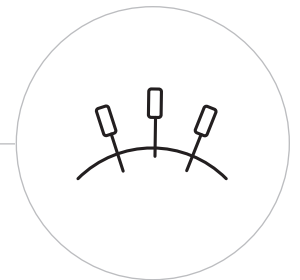

BIOLOGY

The 3B Scientific group has a rich history in this area dating back to 1819 when Calderoni – now Hungary 3B Scientific, was one of the forerunners in natural science education. Engaging Biology classes are the most effective way to create a long-lasting learning experience. 3B Scientific models are perfect tools for fascinating, hands-on education, all cast from actual specimens and made of highest quality material.

PHYSICS

Physics teaching success depends on reaching students with practical, hands-on, inquiry based education. 3B Scientific products support teachers worldwide in mastering this challenge with engaging, exciting products and experiments.

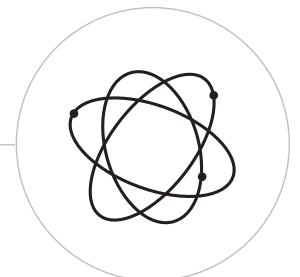

3B Scientific® Physics Production in Germany, Klingenthal



Assembly production at the CNC Processing Centre

The universally recognised high quality of the teaching equipment produced is achieved through a combination of modern process technology with the best traditional craftsmanship. The skills and facilities of the CNC Processing Centre in Klingenthal guarantee not only the mechanical precision that is essential for high-quality physical instruments, but also cost-effective series production with consistently high quality.

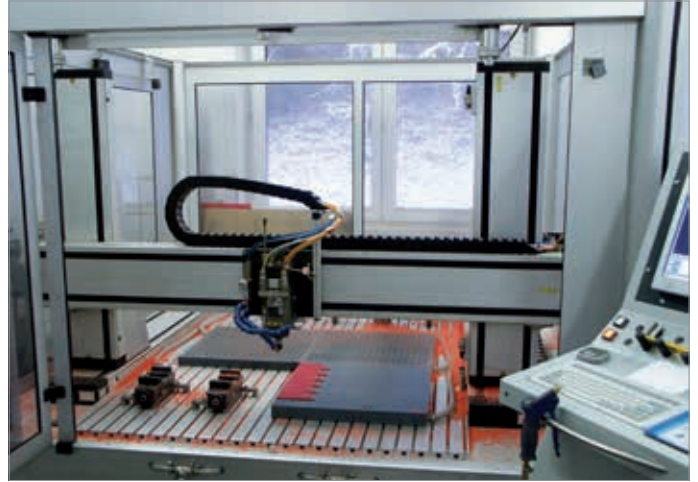

A CAD/CAM workstation

A direct extension from the principles of CAD (Computer Aided Design) is CAM (Computer Aided Manufacturing), here shown being applied to controlling a flat-bed milling machine. This manufacturing technology makes it possible to fulfil special project requirements with speed and with the usual high precision.

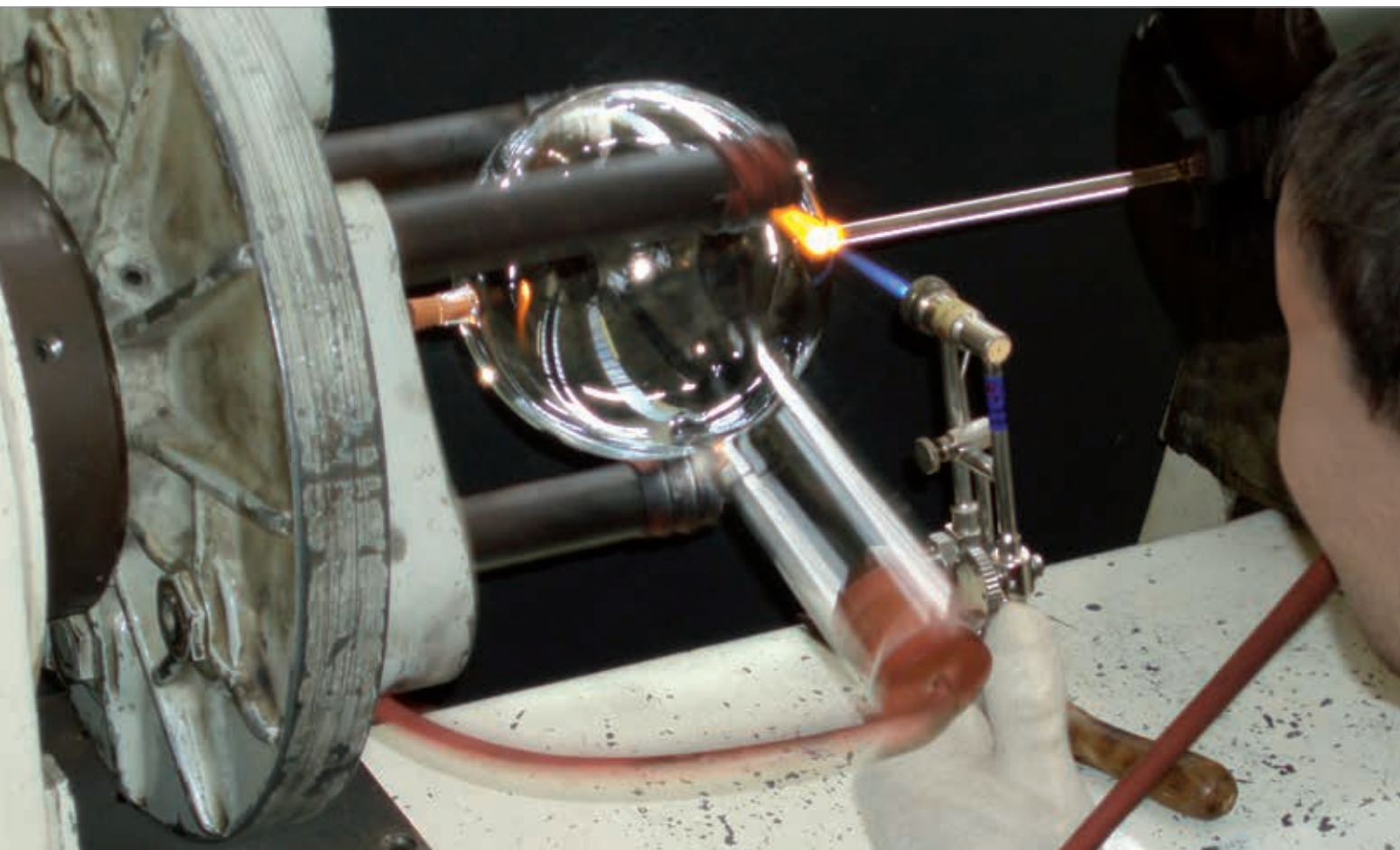

Manufacturing a TELTRON® electron tube at 3B Scientific in Germany

Electron tubes are produced at only a very small number of places in the world. Only specially trained technicians with many years of experience have

the skills that are needed for this technologically advanced manufacturing process, which ensures that every TELTRON® electron tube that you receive from us will have the same consistently high quality.



3B Scientific
A worldwide group of companies



EDUCA
nastavna sredstva i oprema

EDUCA d.o.o., Šibenskih vatrogasaca 14
22000 **Šibenik**, Republika Hrvatska
Tel./fax: 022 218 924, Mob.: 091 356 5655
www.educa-h.hr, e-mail: info@educ-h.hr
Matični broj: 2376059; OIB: 64606800724
Trgovački sud u Šibeniku MBS 100012332
Zagrebačka banka: 2360000-1102021911
IBAN: HR9823600001102021911



Millikan's Apparatus

Compact apparatus for demonstrating the discrete nature (quantisation) of electric charge and for determining the elementary charge of an electron with built-in measurement and display unit. Touch-sensitive screen for simple and ergonomic operation. Built-in pressure and temperature sensor for automatically determining the relevant parameters, temperature, viscosity and pressure.
P-1018884

➤ Page 247